



REGAL®

————— Follow no one.



OWNER'S MANUAL
28 EXPRESS

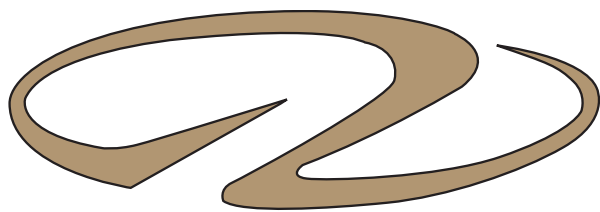

REGAL®

————— Follow no one.



OWNER'S MANUAL

28 EXPRESS



Table Of Contents

1 INTRODUCTION

Your Regal Owner's Manual	1-4
General Information	1-4
Regal Marine Warranty	1-12

2 SAFETY ON BOARD

Safety Labels	2-1
General Boating Safety	2-2
Personal Flotation Devices	2-4
Fire Extinguishers	2-6
Visual Distress Signals	2-7
Sound Protecting Devices	2-10
Radio Communications	2-10
Marine Sanitation Devices	2-10
Navigation Lights	2-11
Garbage	2-12
EBIRB	2-12
Life Rafts	2-13
USCG Minimum Equipment Requirements	2-13
Exhaust & Carbon Monoxide	2-14
Boating & Alcohol	2-16
Boating Accidents	2-17
Water Sports	2-19
Weather & Water Conditions	2-20

3 RULES OF THE ROAD

Navigation Rules-Right Of Way	3-1
Navigation Aids	3-5
Bridge Clearance	3-8

Table Of Contents

4 ENGINES & CONTROLS

Engines	4-1
Propulsion	4-2
Propellers	4-3
Instrumentation	4-3
Remote Control	4-8

5 SYSTEMS

Electrical	5-1
Fuel	5-22
Steering	5-23
Trim	5-24
Water & Waste	5-28

6 VESSEL OPERATION

Getting Underway	6-1
Starting & Stopping	6-4
Fenders	6-5
Dock Line Basics	6-6
Steps To Stern Drive Docking	6-8
Stern Drive Maneuvering	6-9
Anchoring	6-11
Towing	6-12
Admiralty Law	6-12
Knots	6-13
Emergencies	6-14
Environmental Awareness	6-15



Table Of Contents

7 EQUIPMENT OPERATION

Interior Equipment	7-2
Exterior Equipment	7-35
Trailing	7-54

8 COSMETIC CARE & MAINTENANCE

Cosmetic Care	8-1
Maintenance (Interior)	8-7
Maintenance (Exterior)	8-18
Propulsion Maintenance	8-25
Maintenance Schedule	8-29
Maintenance Service Log	8-32

9 TROUBLESHOOTING

Diagnostic Charts	9-1
-------------------	-----

10 STORAGE & WINTERIZATION

Decommissioning Checklist	10-1
---------------------------	------

11 GLOSSARY	11-1
--------------------	------

12 TECHNICAL

Information	12-1
Drawings	12-6

Introduction

Boating is becoming more popular every year. There are numerous types of recreational vessels on our waterways today involved in an every growing number of activities. Therefore, as a new boat owner it is of the highest priority to learn about general boating practices before operating your craft.

Your Regal dealer will answer many questions and provide valuable “hands on” information during the completion of the new boat delivery process. In addition, your dealer has received special factory training on the product line and his services should be employed to solve technical problems and periodic maintenance beyond the scope of this manual. Also, your Regal dealer carries a line of factory approved parts and accessories.

Your Regal dealer can provide information regarding national training organizations such as the U.S. Power Squadron and United States Coast Guard Auxiliary. Along with other organizations and literature, they can help build your “boating savvy” by developing the necessary skills and awareness to be a safe and competent skipper.

Your local library can also help in providing recommended boating literature such as *Chapman Piloting (Seamanship & Boat Handling)* by Elbert S. Maloney).

Remember, the waterways can change conditions almost in a heartbeat. Knowing how to react quickly comes from experience and knowledge which can be gained through boating education and practical experience on the water.

In addition, the internet can enhance your boating skills. If you visit Utube there is a group of Regal related videos under Quick Tips with Captain Frank . These videos were developed on Regal boats and cover a variety of system topics including water, waste, air conditioning and electrical systems. New topics are being continuously developed so bookmark that page so you can quickly access it.

Welcome Aboard!



WELCOME TO REGAL

I know I speak for everyone at Regal when I welcome you to the ever-growing family of Regal boat owners. You've chosen a craft that is recognized worldwide for its standard of excellence. Each step in construction has been carefully scrutinized to assure comfort, performance, reliability and safety for both your passengers and yourself.

Your boat is certified by the National Marine Manufacturers Association. It also complies with the applicable standards set by the United States Coast Guard, American Boat and Yacht Council plus the International Marine Certification Institute. Your Regal boat was built with the same attention to detail and quality of construction that we would expect in a boat we would purchase ourselves.

Whether you're a veteran boater or a newcomer, we strongly urge you to read this boat owner's manual thoroughly. Familiarize yourself with the various components of your boat, and heed the safety precautions noted herein.

If you have questions that are not covered in this manual, please consult your authorized Regal dealer for assistance or phone the Regal factory at 407-851-4360.

Thank you, and welcome to the "World of Regal!"

*Duane Kuck
President/CEO*

**REGAL MARINE INDUSTRIES, INC.
MISSION STATEMENT**

With God's help

and a steadfast commitment to integrity,

we will develop a team

of exceptional people and relationships

to provide exceptional customer satisfaction.



YOUR REGAL OWNER'S MANUAL

Your Regal owner's manual has been compiled to help you operate your craft with safety and pleasure. It contains specific details of the craft, the equipment, its systems, and information on its operation and maintenance. Please read it carefully and familiarize yourself with the craft before using it.

This manual is not to be thought of as a complete shop technical manual. Your Regal dealer has received special factory training on our complete product line and his services should be employed to solve technical problems. In addition to your Regal owner's manual, we have provided additional paperwork in an owner's information pouch or carrying bag. They contain important equipment literature along with vendor and warranty information.

Please ensure that you obtain handling and operating experience before assuming control of your boat. Your dealer will be pleased to advise you of local training organizations such as the Power Squadron and United States Coast Guard Auxiliary.

Contact your local dealer if any of the above material is missing. In keeping with its commitment to continued improvement, ***Regal notes that all specifications, models, standard and optional equipment mentioned in this manual are subject to change without notice.***

OWNER'S INFORMATION

Regal has provided an information folder or carrying bag aboard the vessel. Read and become familiar with the materials. This packet contains valuable literature on your propulsion package, standard and optional equipment, systems and various care and cleaning instructions. Be sure to store the information pouch or carrying bag in a clean dry area for quick reference.

GENERAL INFORMATION

HULL IDENTIFICATION NUMBER (HIN)

The United States Coast Guard has established a universal system of numerically identifying vessels by using a hull identification number or "HIN." This number identifies your Regal boats' model, hull number, month and year of manufacture. The HIN is found on the starboard side of the transom just below the rub rail or swim platform on the vertical gelcoat surface. The current HIN consists of 12 alpha or numeric characters.

It is recommended that you locate and write down the HIN for future reference. Make a listing in the owner's manual. It can be especially useful when purchasing vessel insurance or ordering parts from your Regal dealer. A second HIN number is found in a hidden location. This second HIN is useful to authorities if the boat is stolen and the original transom HIN is modified or eliminated.

Introduction

HULL IDENTIFICATION NUMBER

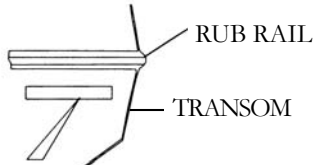

HIN NUMBER/TYPICAL LOCATION

NMMA YACHT CERTIFICATION PLATE

At the helm area is located a metal plate which recognizes that your boat was built to design compliance in effect on the date the certification was verified. The plate also states that your vessel complies with U. S. Coast Guard safety standards in effect on the date of certification.

VESSEL INFORMATION SHEET

It is recommended that you fill out the information on the following page. It will supply vital statistics on your vessel. Make a copy of the data for safe keeping at home.

VESSEL FLOAT PLAN

Fill out the float plan on the following page before departing. Leave it with a responsible person who will notify the United States Coast Guard or local law enforcement authorities if you do not return as planned. If you change your plans be sure to notify this person. Make copies of the float plan and use one each time you go boating. This will help people know where to find you should you not return on schedule. Do not file the float plan with the United States Coast Guard.

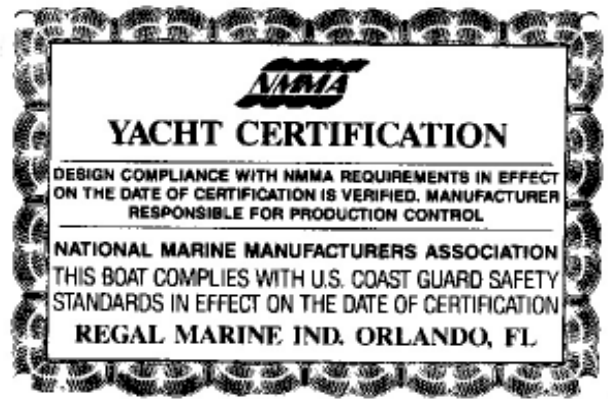



VESSEL INFORMATION

Owner: _____

Address: _____

City & State: _____

Home Phone: _____ Business Phone: _____

In Case Of Emergency Notify: _____

Address _____

City _____ State _____

Phone _____

Insurance Agent's Name: _____

Policy#: _____

USCG Phone: _____ Local Police: _____

Marina Phone: _____ Slip (Dock#): _____

Hull Serial #: RGM _____

Key #: _____ Port Engine: _____ Stbd Engine: _____

Key #: _____ Cabin Door: _____

Selling Dealer: _____

Address: _____

City & State: _____

Phone: _____ Fax: _____

Servicing Dealer: _____

Address: _____

City & State: _____

Phone: _____ Fax: _____

FLOAT PLAN

Fill out this form before departure. Leave it with a responsible person who will notify the Coast Guard or police if you don't return as planned. If you change your plans be sure to notify this person. Make copies of the float plan and use one each time you go on a trip. This will help people know where to find you should you not return on schedule. Do not file this plan with the Coast Guard.

Owner: _____
Address: _____
City & State: _____
Telephone#: _____

Person Filing Report: _____
Name _____
Telephone _____

Make Of Boat: _____
Length _____ Boat Name _____
Color _____ Trim _____ Hp _____
Inboard _____ Outboard _____
Hull I.D.# _____

Other Information: _____

Safety Equipment Aboard: _____
Life Jackets
First Aid Kit
Flares
Flash Light
VHF Radio
Anchor
Compass
Food
Water

Registration# _____
Destination:
Leave From _____
Time Left _____
Going To _____
Fuel Capacity _____
Est. Time Of Arrival _____

Return: _____
Est. Time Of Arrival _____
If Not Back By _____ o'clock Call Coast Guard

Persons Aboard:

Table with 4 columns: Name, Age, Address, Phone. Includes 5 rows of blank lines for data entry.



LAUNCH & CRUISE CHECKLIST

- Obtain a current weather report.
- Inspect the hull and propeller for damage. Excessive dirt or marine growth will affect your boat's performance and fuel efficiency.
- Check the electrical system and navigation lights.
- If your boat has been in the water, run the bilge pump until the flow of water stops.
- If your boat has been out of the water, check to see that all bilge water has drained out. Then install the drain plug.
- Check that all required safety equipment is on board and in good working condition. Examples include personal flotation devices (PFD's), horn, fire extinguishers, visual distress signals, etc. Take along a gallon of drinking water.
- Check that all other equipment is on board such as mooring lines, first aid kit, tool kit and extra parts.
- Open engine compartment. Inspect for fuel odors and visible leaks in the fuel, oil, coolant, exhaust and power steering systems.
- Visually inspect engine for cracked hoses, defective belts, and loose fasteners such as bolts, nuts or hose clamps.
- Check fuel level. Fuel tanks should be filled to slightly less than capacity. Allow for fuel expansion.
- Make sure all navigation charts, equipment and vessel registration paperwork are on board.
- Check operation of bilge blower, steering system, navigation lights and horn.

RECOMMENDED ON BOARD EQUIPMENT

TOOLS

Allen Wrenches
Jack Knife
Phillips Screwdriver Set
Slotted Screwdriver Set
Combination Box & End Wrench Set
Pliers
Ratchet & Socket Set
Electrical Crimper & Cutter
Hammer
Jumper Cables
Battery Terminal Remover
Vise Grip
Floating Flashlight/Lantern
GFIC Tester
Electrical Strippers
Oil & Fuel Filter Wrench

SPARE PARTS

Fuel Filter
Spark Plugs
Water Pump Belt
Alternator Belts
Anti-siphon Valve
Extra Propellers
Propeller Nuts & Hardware
Extra Light Bulbs/Batteries
Fuses
Liquid Wrench & Oil
Gear Lubricant
Water Pump Impeller
Funnel
Duct & Electricians Tape
Surpentine/V Belt
Engine & Transmission Oil

BASIC GEAR

Tow Line
Mooring Lines
Dock Fenders
Distress Signals
First Aid Kit
Boat Hook
Foul Weather Gear
VHF Radio
Charts & Plotting Instruments
Emergency Water & Food
Bailer or Hand Bilge Pump
EPIRB & Fire Extinguisher
Personal Floatation Devices
Life Raft
Clean Rags & Bucket
Cell Phone



Owner's Registration & Systems Checklist

Please note that your Regal boat requires the proper registration by your authorized Regal dealer. To initiate your warranty your dealer must complete the owner's registration form and systems checklist at the time of delivery. The owner must sign the paperwork to acknowledge that the dealer has reviewed the boat systems and warranty provisions with the owner. The owner should keep the original paperwork that features temporary warranty registration. A warranty certificate will be sent approximately 3-4 weeks after receipt of the paperwork at Regal headquarters.

Dealer's Responsibility

Your boat has undergone rigid quality assurance inspections before leaving the factory. However, your dealer has been trained to perform final pre-delivery checks and to service your Regal boat prior to your pickup. Your dealer's responsibilities include:

A complete orientation in the operation of your Regal boat, including matters relating to the safe operation of your craft.

Completion and mailing of your boat registration warranty form to Regal.

Warranties, registration materials, owner's manual, operation, installation and maintenance instructions for all auxiliary equipment supplied with or installed on your Regal boat.

Owner's Responsibility

You are entitled to all the benefits and services outlined in your Regal boat warranty. However, you have certain responsibilities to ensure warranty satisfaction.

These are:

To read the warranty materials and understand them fully.

To examine the boat in detail at the time of delivery.

Apply the following: boating rules and regulations, safety equipment, environmental regulations, accident reports and warranty regulations terms and conditions.

To read thoroughly all literature supplied with your boat, including this owner's manual and to follow the recommendations in the literature.

To return the boat after the recommended hours of engine operation for the proper dealer service inspections.

To provide proper maintenance and periodic servicing of your boat and equipment as set forth in the various manuals supplied.



REGAL MARINE INDUSTRIES, INC. LIFETIME PLUS LIMITED HULL WARRANTY

Welcome to the Worldwide Family of Regal Owners! We are very pleased that you have chosen a Regal Powerboat!

This document is your Warranty Registration Certificate and Statement of Warranty. Please check the registration information section for accuracy. If this information is not correct or if you change your address at some future date, please notify us at the following address: Regal Marine Industries, Inc. Attention: Warranty Registrations, 2300 Jetport Drive, Orlando, Florida 32809

Please read the warranty carefully. It contains important information on Regal's claims procedures and your rights and obligations under this warranty.

WHAT IS COVERED: This Limited Warranty applies only to Regal beginning with model year 2005.

LIFETIME LIMITED STRUCTURAL HULL WARRANTY: Regal Marine Industries, Inc. warrants to the original retail purchaser of this boat if purchased from an authorized Regal dealer that the selling dealer or Regal will repair or replace the fiberglass hull if it is found to be structurally defective in material or workmanship for as long as the *original* retail purchaser owns the boat. For purposes of this warranty, the hull is defined as the single fiberglass casting which rests on the water. This limited warranty is subject to all limitations and conditions explained below.

FIVE-YEAR TRANSFERABLE LIMITED STRUCTURAL HULL WARRANTY: In addition to the Lifetime Limited Structural Hull Warranty, Regal offers a Transferable Five-Year Limited Structural Hull Warranty. Under the Five-Year Transferable Limited Structural Hull Warranty, Regal will repair or replace the fiberglass hull if it is found to be structurally defective in material or workmanship within the first (5) years after the date of delivery to the original retail purchaser. Any remaining term of this Five-Year Limited Hull Warranty may be transferred to a second owner if within 60 days of purchase, the new owner registers the transfer with Regal and pays the established warranty transfer fee. Contact Regal Customer Service at the above address for details.

FIVE-YEAR LIMITED HULL BLISTER WARRANTY: Regal warrants that the selling dealer or Regal will repair any underwater gelcoated surfaces of the hull against laminate blisters which occur as a result of defects in material or workmanship within (5) years of the date of delivery, provided that the original factory gelcoat surface has not been altered. Alternation would include but is not limited to damage repair; excessive sanding, scraping, sandblasting; or from improper surface preparation for application of a marine barrier coating or bottom paint, any of which shall void this Five-Year Limited Hull Blister Warranty. Proper preparation must be applied to the hull bottom if the boat is to be moored in the water for periods in excess of (60) days. Regal Marine shall repair or cause to be repaired any covered laminate blisters based on the following prorated schedule.

Less than two (2) years from delivery date - 100%, Two (2) to three (3) years from delivery date - 75%, Three (3) to four (4) years from delivery date - 50%, Four (4) to five (5) years from delivery date - 25%.

Reimbursement shall be limited to one repair, not to exceed (\$80.00) dollars per foot of boat length prior to prorating. Regals prior authorization for the method and cost of repair, must be obtained before repairs are commenced. All costs to transport the boat for repairs are the responsibility of the owner.

LIMITED GENERAL WARRANTY: In addition to above hull warranties, Regal warrants to the original purchaser of this boat if purchased from an authorized dealer that the dealer or Regal will repair or replace any parts found to be defective in materials or workmanship for a period of one (1) year from the date of delivery, subject to all limitations and conditions contained herein.

LIMITED EXTERIOR FINISH WARRANTY: Regal warrants that the selling dealer or Regal will repair cosmetic defects in the exterior gelcoated finish including cracks or crazing reported to Regal within 90 days from the date of delivery to the original purchaser, subject to all limitations and conditions contained herein. All warranty work is to be performed at a Regal dealership or other location authorized by a Regal Customer Service Manager after it is established to Regal's satisfaction that there is a defect in material or workmanship.

REGISTRATION INFORMATION:

Introduction

CUSTOMER OBLIGATIONS: The following are conditions precedent to the availability of any benefits under these limited warranties:

- (a) The purchaser must sign and the dealer must submit to Regal the "OWNER REGISTRATION AND SYSTEMS CHECKLIST FORM" within ten (10) days of the date of delivery and such information must be on file at Regal.
 - (b) The purchaser must first notify the dealer from whom the boat was purchased of any claim under this warranty within the applicable warranty period and within a reasonable period of time (not to exceed thirty (30) days) after the defect is or should have been discovered.
 - (c) Regal will not be responsible to repair or replace any part, (1) if the use of the boat is continued after the defect is or should have been discovered; and (2) if such continued use causes other or additional damage to the boat or component parts of the boat.
 - (d) Based on the dealer's knowledge of Regal's warranty policy and/or consultations with Regal, the dealer will accept the claim and arrange for appropriate repairs to be performed, or deny the claim if it is not within the warranty.
 - (e) The dealer will contact the Regal boat owner regarding instructions for delivery of boat or part for warranty repair if it is covered by the limited warranty.
- ALL COSTS TO TRANSPORT THE BOAT FOR REPAIRS ARE THE RESPONSIBILITY OF THE OWNER;
- (f) If the Regal boat owner believes a claim has been denied in error or the dealer has performed the warranty work in an unsatisfactory manner, the owner must notify Regal's Customer Service Department in writing at the address listed for further consideration. Regal will then review the claim and take appropriate follow-up action.

WARRANTY EXCEPTIONS: THIS LIMITED WARRANTY does not cover and the following are not warranted:

- (a) Engines, metal plating or finishes, windshield breakage, leakage, fading and deterioration of paints, canvas, upholstery and fabrics;
- (b) Gelcoat surfaces including, but not limited to, cracking, crazing, discoloration or blistering except as noted above;
- (c) Accessories and items which were not part of the boat when shipped from the Regal factory, and/or any damage caused thereby;
- (d) Damage caused by misuse, accident, galvanic corrosion, negligence, lack of proper maintenance, or improper trailering;
- (e) Any boat used for racing, or used for rental or commercial purposes;
- (f) Any boat operated contrary to any instructions furnished by Regal, or operated in violation of any federal, state, Coast Guard or other governmental agency laws, rules, or regulations;
- (g) The limited warranty is void if alterations have been made to the boat;
- (h) Transportation of boat or parts to and/or from the REGAL factory or service location;
- (i) Travel time or haul outs, loss of time or inconvenience;
- (j) Any published or announced catalog performance characteristics of speed, fuel and oil consumption, and static or dynamic transportation in the water;
- (k) Any boat that has been repowered beyond Regal's power recommendations;
- (l) Boats damaged by accident and boats damaged while being loaded onto, transported upon or unloaded from trailers, cradles, or other devices used to place boats in water, remove boats from water or store or transport boats on or over land;
- (m) Water damage to, dry rot to, condensation to, or absorption by interior surfaces, wood structures or polyurethane foam; interior wood including, but not limited to, bleeding and/or discoloration as a result of condensation or moisture or water continually contacting the plywood causing staining to upholstery, carpet or other interior surfaces;
- (n) Costs or charges derived from inconveniences or loss of use, commercial or monetary loss due to time loss, and any other special, incidental or consequential damage of any kind or nature whatsoever.

WARRANTY EXCEPTIONS: The terms, conditions, limitations and disclaimers contained herein cannot be waived except by the Customer Service Manager of Regal. Any such waiver must be in writing. Neither the dealer, nor the customer, nor any service, sales and/or warranty representative of Regal is authorized to waive and/or modify these conditions, limitations and/or disclaimers.

GENERAL PROVISIONS:

ALL GENERAL, SPECIAL, INDIRECT, INCIDENTAL AND/OR CONSEQUENTIAL DAMAGES ARE EXCLUDED FROM THIS WARRANTY AND ARE TOTALLY DISCLAIMED BY REGAL. IT IS THE INTEREST OF THE PARTIES THAT THE OWNER'S SOLE REMEDY IS THE REPAIR OR REPLACEMENT OF THE VESSEL OR ITS ALLEGEDLY DEFECTIVE COMPONENT PARTS AND THAT NO OTHER LEGAL OR EQUITABLE REMEDIES SHALL BE AVAILABLE TO SAID OWNER. SOME STATES DO NOT ALLOW THE EXCLUSION OF INCIDENTAL OR CONSEQUENTIAL DAMAGES SO THE FOREGOING MAY NOT APPLY TO YOU.



Chapter 1

THIS IS A LIMITED WARRANTY; REGAL MAKES NO WARRANTY, OTHER THAN CONTAINED HEREIN; TO THE EXTENT ALLOWED BY LAW ANY WARRANTIES OF MERCHANTABILITY OR FITNESS FOR A PARTICULAR PURPOSE ARISING IN STATE LAW ARE EXPRESSLY EXCLUDED TO THE EXTENT ALLOWED BY LAW. ANY IMPLIED WARRANTY OF MERCHANTABILITY IS LIMITED TO THE PERIOD OF THIS LIMITED WARRANTY. ALL OBLIGATIONS OF REGAL ARE SPECIFICALLY SET FORTH HEREIN. REGAL DOES NOT AUTHORIZE ANY PERSON OR DEALER TO ASSUME ANY LIABILITY IN CONNECTION WITH REGAL BOATS. Some states do not allow limitations on how long an implied warranty lasts, so the above limitation may not apply to you. Regal's obligation with respect to this warranty is limited to making repairs to or replacing the defective parts and no claim for breach of warranty shall be cause for cancellation or rescission of the contract or sale for any boat manufactured by REGAL MARINE INDUSTRIES, INC.

Regal will discharge its obligations under this warranty as rapidly as possible, but cannot guarantee any specific completion date due to the different nature of claims which may be made and services which may be required. Regal reserves the right to change or improve the design of its boats without obligation to modify any boat previously manufactured. This limited warranty gives you specific legal rights, and you may also have other rights which may vary from state to state.

Regal shall in no way be responsible for any repairs not PRE-AUTHORIZED by a Regal Customer Service Manager or repairs performed by a repair shop not PRE- AUTHORIZED by a Regal Customer Service Manager.

Safety On Board

Safety awareness can't be over emphasized. Safety on board needs to be the skippers number one priority. In this manual you will find many safety precautions and symbols to identify safety related items. Heed all safety precaution information. Remember, the skipper is responsible for the safety of his passengers and crew.

SAFETY LABELS

Safety Precaution Definition

Safety precautions are stated as caution, warning and danger signal words. They are highlighted in this manual by font design and symbol usage. Also, a notice heading is included which provides operation and maintenance information **but is not hazard-related**. **Become familiar and understand all safety precaution labels!**

 WARNING
Potentially hazardous situation that, if not avoided, could result in death or serious injury.

 CAUTION
Indicates a potentially hazardous situation or unsafe practice that, if not avoided, may result in injury or property or product damage..

NOTICE
General or specific information which is important to correct operation or maintenance, but is not hazard related .

 DANGER
Immediate hazardous situation that, if not avoided, will result in death or serious injury..



PRECAUTIONARY LABELS

Read and understand all safety labels affixed to your Regal boat. Most of the safety labels are found close to the helm, aft cockpit and or swim platform. The location of the labels may vary by model. The label list does not cover everything! Use common sense to analyze the result of an action onboard your vessel. **Always think safety first!**

NOTICE

DO NOT REMOVE OR COVER ANY
PRECAUTIONARY LABELS.
KEEP HARSH CHEMICALS
AWAY FROM LABELS.
IF A LABEL BECOMES ILLEGIBLE,
CONTACT YOUR REGAL DEALER
FOR ORDERING REPLACEMENTS.

GENERAL BOATING SAFETY

We understand that you are eager to get your Regal boat on the water. However, we strongly suggest that you thoroughly familiarize yourself and friends or members of your family with safe boating practices before setting out.

Remember, that along with the freedom and exhilaration of boating comes the responsibility that you have for the safety of your passengers and other boaters who share the water with you.

Boating regulations vary from state to state. Check with your local state and local authorities for the regulations pertaining to your area.

- ◆ Check with local weather stations, the U. S. Coast Guard, or weather station broadcasts for the latest conditions. Remember getting caught in severe weather is hazardous, Check weather conditions periodically while you are boating and before your outing. If you are forced to operate your boat in a storm condition, take common sense precautions; wear PFD's, store gear, reduce speed and head for safe refuge.

- ◆ It is best to avoid operating your boat in foggy weather. When fog sets in, take bearings, log courses and speeds. You are required to emit a five second blast from your horn or whistle once every minute. Also, have your passengers wear PFD's and observe for oncoming vessels.

- ◆ Operate in shallow water presents a number of hazards including sand bars and water levels influenced by tides. If the vessel strikes an underwater hazard, check for boat and engine damage. If the engine vibrates excessively after striking an underwater obstruction, it may indicate a damaged propeller. If you run aground, seek help by radio or flares.

- ◆ Make sure your boat and equipment are in top condition. Do this by frequently inspecting the hull, engine and all the gear.

Safety On Board

◆ You must provide a Coast Guard approved personal flotation device (PFD) for every person on board. These PFD's should be in good condition and easily accessible.

◆ Insist that non-swimmers and children on board wear a PFD at all times. Any time you encounter rough weather conditions, make sure everyone on board is wearing a PFD, including yourself. Instruct your passengers in how to put on their PFDs and be sure they know their storage location on the boat. Remember, in an emergency, a PFD that cannot be quickly located and worn is useless.

◆ Never allow anyone to sit anywhere on the boat not specifically designed seating. While underway, **ALWAYS** insist passengers sit in the provided seating and set an example by doing this yourself.

◆ **Use maximum caution when fueling.** Never allow any smoke or flame nearby while you are fueling. **ALWAYS** check for fuel leaks and fumes when fueling is completed.

◆ **Never overload your boat!** An overloaded boat, or one with uneven weight distribution can be difficult to steer.

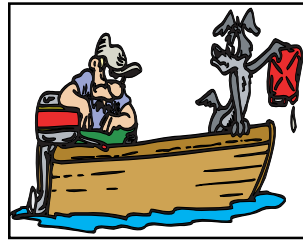

◆ **Be certain there is enough fuel aboard for your cruising needs.** Include any reserve that might be needed should you change your plans due to weather or emergency. **Practice the “one-third rule:** Use one-third of your fuel going out, one-third to return and keep one-third as a reserve.

◆ Always check the weather before departure. Be particularly cautious of electrical storms and high winds.

◆ Always have up-to-date charts aboard. You will need current charts of the area you'll be cruising to stay on proper course. Charts can be obtained at your closet marine outlet or store or by contacting one of three federal government agencies.

◆ **Always file a float plan.** Leave details of your trip with someone responsible who will be remaining on shore. Include expected return, plus name and phone number of a contact person in case of emergency.

◆ Use care, courtesy and common sense when launching, docking or operating your boat.

◆ **Learn and obey the “Rules of the Road”.** A copy of the “Rules of the Road” can be obtained from the U. S. Coast Guard Auxillary or local Power Squadron.

◆ **Never drink and drive!** As captain, you are responsible for the safety of your passengers and yourself. Alcohol and boating can be a dangerous combination. **DO NOT** mix them. Alcohol impairs the boat operators ability to make conscious decisions and react to



emergency situations quickly.



◆ In case of emergency: Know the international distress signals if you have a VHF radio aboard. The spoken word **“MAYDAY”** is the international signal of distress and is for emergency use only. Under no circumstances should this word be used, unless there is danger at hand.

◆ Posted speed limits, swimming areas, “no wake” zones and other restrictions should be red-flagged. They are so noted for a reason. Sensible boat use, plus courtesy, equals enjoyable and safe boating.

◆ It is your responsibility to stay abreast of all federal, state and local rules, as some laws or regulations may change or be different from state to state. Contact your local boating agencies for updated information.

◆ We can not stress safety enough! Remember, there are no brakes on your boat, and the water current and wind velocity all affect your ability to respond. The driver must use caution at all times to maintain control of his vessel and especially to maintain a safe distance from other boats and obstacles.

◆ **Always keep all safety gear in optimum condition.** Pay special attention to attached tags and plates indicating expiration dates on equipment such as fire extinguishers, and personal flotation devices. Encourage a periodic maintenance check on all safety equipment. Contact your Regal dealer or marine professional for more information. Again, remember that the captain is responsible for his passengers and vessel.

REQUIRED SAFETY EQUIPMENT

PERSONAL FLOTATION DEVICES

All personal flotation devices (PFD's) must be Coast Guard approved, in good working condition, and must be the correct size for the wearer. All PFD's must be readily accessible. This means being able to wear them in a reasonable amount of time in case of an emergency (fire, boat sinking, etc.). They should not be stored or locked in closed areas. Also, make sure that all coverings are removed such as plastic from any PFD's. Throwable devices such as a ring buoys need to be available for **immediate** deployment. A PFD should be worn at all times when your boat is operating on the water. A PFD may save your life, but it must be worn to do so.

As minimum U. S. Coast Guard requirements all recreational boats must carry one type I, II, III, or V PFD (wearable) for each person aboard. See the explanation following for each type. For type V to be counted they must be used according to the label instructions. In addition, all boats over 16' must carry one Type IV (throwable) PFD.

Some states require that PFD's be worn by children of specific ages at all times. Check with state boating agencies for particular requirements in your state before taking children on the water.

Remember PFD's will not necessarily keep you from drowning, even though they are designed to keep a person from sinking. When purchasing PFD's make sure it safely fits the person wearing it. It is a good idea to test PFD's in a lifeguarded shallow pool before venturing on the water.

Safety On Board

Refer to the USCG minimum equipment requirements at the end of this chapter. It is meant to be a guide only. Contact state and local agencies for additional equipment requirements. Remember as the captain of your vessel you are responsible for its safe operation.

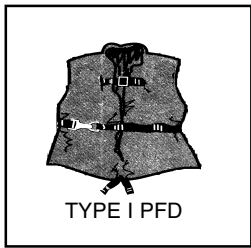

TYPE I- Also known as an off-shore jacket, it provides the most buoyancy. It is a PFD for all waters and is especially useful in rough waters where rescue may encompass additional time. It is designed to turn most unconscious users in the water to a face-up position. Type I PFD is available in adult & child sizes.

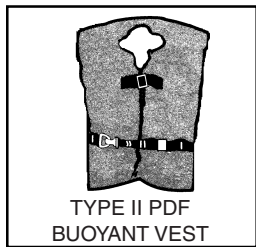

TYPE II- Also known as near-shore buoyant vest, it is recommended for calm, inland water where rescue time will be minimal. It will turn some unconscious people face-up in the water but not as numerous as Type I. They are available in adult, medium child, along with infant and small child sizes.

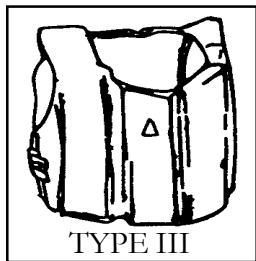

TYPE III- Known as a flotation aid it is good for calm, inland water or where there is a chance for quick rescue. It is designed so wearers can place themselves in a face-up position in the water. The wearer may have to tilt their head back to avoid turning face-down in the water.

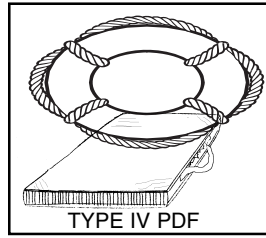

TYPE IV- Intended for calm, inland water with heavy vessel traffic, where help is constantly present. It is designed to be thrown into the water for someone to grab on to and held until rescued. It should *not* be worn. Type IV includes ring buoys, buoyant cushions, and horseshoe buoys.

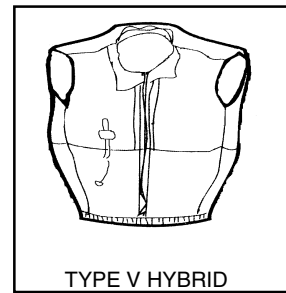

TYPE V- This is the least bulky of all PFD's. It contains a small amount of inherent buoyancy, and an inflatable chamber. It is rated even to a Type I, II, or III PFD (as noted on the jacket label) when inflated. Hybrid PFD's must be worn to be acceptable.



MAINTAINING YOUR PFD'S

A PFD is only useful if it is well maintained. Always be aware of PFD age since it has a life expectancy like any other piece of equipment.

√ Check periodically for broken zippers, frayed webbing, water soaked kapok bags, missing straps, and sewing that has become undone.

√ Clean each PFD with mild soap and water only. Again, let dry sufficiently before storing.

√ Keep PFD's out of grease and oil since they can deteriorate the jacket inner and outer materials.

√ Check any kapok-bagged jackets by squeezing. If you hear air escaping the bag is defective and the PFD should be thrown away.

√ Grab the cover with the fingers. If the cover material rips, the PFD is rotted and should be thrown away.

√ If the kapok bag is hard the PFD should be discarded.

FIRE EXTINGUISHERS

GENERAL INFORMATION

Fire extinguishers are classified by a letter and numeric symbol. The letter references the type of fire the unit is designed to extinguish.

(For example, type B extinguishers commonly used on boats are designed to put out flammable liquids such as grease, oil and gasoline.

The number indicates the general size of the extinguisher (minimum extinguishing agent weight).

FIRE EXTINGUISHER CONTENTS				
CLASS	FOAM IN GALS.	CO2 IN LBS.	DRY CHEM IN LBS.	LIQUID GAS IN LBS.
B-I	1.25	4	2	2.5
B-II	2.5	15	10	10

MINIMUM PORTABLE FIRE EXTINGUISHERS REQUIRED		
VESSEL LENGTH	NO FIXED SYSTEM	WITH FIXED SYSTEM
LESS THAN 26'	1 B-1	0
26' TO LESS THAN 40'	2 B-1 OR 1 B-II	1 B-1
40' TO 65'	3 B-1 OR 1 B-II AND 1 B-1	2 B-1 OR 1 B-II

Safety On Board

U. S. Coast Guard approved fire extinguishers are required on all Regal boats. Besides the **minimum** Coast Guard requirements always check state and local agencies for additional requirements and equipment.

Coast Guard approved extinguishers are hand-portable, either B-I or B-II classification. U. S. Coast Guard approved hand-portable and semi-portable extinguishers contain a metal plate that shows the manufacturers name and extinguisher type, capacity and operating instructions. They have a special marine type mounting bracket which keeps the extinguisher solidly mounted until needed. The extinguisher needs to be mounted in a readily accessible location but one out of being bumped by people while underway. All approved extinguishers need to have an indication gauge.

USCG APPROVED FIRE EXTINGUISHER TYPES & FEATURES



■ The dry chemical agent is widely used because of its convenience and low cost. The extinguisher canister is filled with a white dry chemical power along with a pressurized gas. It is a good idea to shake this type periodically because they tend to

“pack” on the canister bottom.

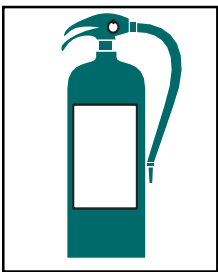

■ The foam type uses a chemical foaming agent plus water and is best when used for fires involving flammable liquids- solvents, gasoline, oil, grease and various paints. It will work on fires involving rubber, plastics, cloth, wood, and paper. It leaves a messy residue. Do not use this

extinguisher for electric fires.



■ The carbon dioxide unit uses CO2 gas under high pressure, with a funnel discharge hose usually swivel mounted. This extinguisher leaves no residue and does not cause interior engine harm. To ensure workability, weigh the unit annually. A 10%

maximum weight variance is allowed.

Another type is liquified gas. This gas is colorless and odorless, heavier than air and sinks to the lower bilge to extinguish fires. Since the year 2000 ingredients for liquid gas has changed to a more environmental friendly formula. Liquid gas is used in portable-hand units along with making up the majority of boat automatic fire extinguishing systems. The canister needs to be weighed once a year. Liquid gas units must feature a dash mount indicator.

Refer to the information regarding fire prevention in this manual.

VISUAL DISTRESS SIGNALS

All vessels used on coastal waters, any of the Great Lakes, territorial seas, and those waters connected directly to them up to point where a body of water is less than two miles wide, must have Coast Guard approved visual distress signals.



PYROTECHNIC DEVICES

Pyrotechnic visual distress signals must be Coast Guard approved, be ready for service and must be readily accessible. They all display a marking which is the service life, which must not have expired. A minimum of 3 devices are required for the day and 3 devices for night. Some devices meet both day and night requirements. Pyrotechnic devices should be stored in a cool, dry location. Most of these devices can be purchased in an highly visible (orange) watertight container. Types of Coast Guard approved pyrotechnic distress signals and associated devices are:

- Pyrotechnic red flares, hand-held or aerial type.
- Pyrotechnic orange smoke, hand-held or floating type.
- Launchers for parachute flares or aerial red meteors.

All in all, each distress signal has certain advantages and disadvantages.

There is no distress signal that is best under all situations.

NON-PYROTECHNIC DEVICES

Pyrotechnics are recognized world-wide as superior distress signals. A downfall is they emit a very hot flame that can cause burns and or ignite flammable materials. Pistol launched and hand-held parachute flares operate consistent with firearms and therefore must be carefully handled. Check with local and state regulations since some of these devices are considered firearms and are prohibited.

Non-pyrotechnic devices must all be in serviceable condition, readily accessible, and must be certified by the manufacturer to comply with Coast Guard standards. They include:

- Orange distress flag.
- Electric distress flag.

The distress flag is for day use only. It must be 3 x 3 or larger with a black square and ball on an orange background. It can be spotted when attached to a boat hook, long fishing rod, or paddle with the person waving the flag back and forth overhead.

The electric distress flag is for night use only flashing the international SOS distress signal (... _ _ _ ...).

Under Inland Navigation Rules, a high intensity white light that flashes at regular intervals from 50-70 times per minute is considered a distress signal.

Remember that regulations prohibit the display of visual distress signals on the water under any circumstances except when assistance is required to prevent immediate or potential danger to passengers on a vessel.

Safety On Board

INTERNATIONAL DISTRESS SIGNALS

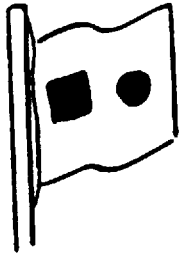

BLACK SQUARE
AND BALL ON
ORANGE BACKGROUND

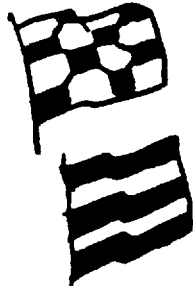

CODE FLAGS
NOVEMBER
& CHARLIE



SQUARE FLAG
& BALL



PERSON
WAVING
HANDS

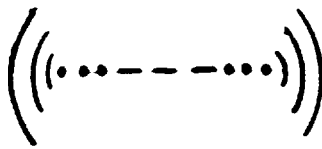

MORSE
CODE S.O.S.



"MAYDAY"
BY
RADIO

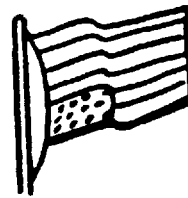

ENSIGN
UPSIDE
DOWN



PARACHUTE
RED FLARE



RED METEOR
FLARES



SMOKE



FOG HORN
SOUNDED
CONTINUOUSLY



GUN FIRED AT
1- MINUTE
INTERVALS

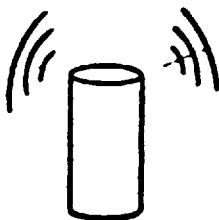

POSITION
INDICATING
RADIO BEACON



DYE MARKER
(ANY COLOR)



HAND-HELD
FLARE



SOUND PRODUCING DEVICES

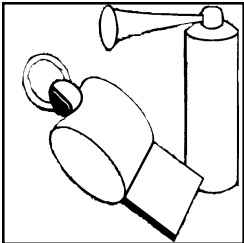

According to both Inland and International Rules, all boats **must** carry some way of producing an efficient sound signal. If your vessel is 12 meters (39' 4") or longer, a power whistle, power horn or bell must be carried. The bell must be a minimum of 7 7/8" in diameter.

Boats less than 12 meters a horn or whistle is **recommended** to signal intentions or signal position. The sound signal made in all cases must be capable of a four or six second blast audible for one half mile. See the section discussing bridge and whistle signals for more information.

RADIO COMMUNICATIONS

VHF radios are used for distress and ship to shore and ship to ship communications today. Learn the specialized messages such as

Mayday, Mayday, Mayday is only used when life or vessel is in imminent danger.

NAVIGATION LIGHTS

The U. S. Coast Guard requires recreational boats operating at night to display navigation lights between sunset and sunrise. Navigation lights help avoid collisions by improving the night visibility of vessels. Red and green directional lights, white stern lights, white masthead lights and white all-around lights must be displayed in specified positions, depending on boat size, and mode of operation.

The configuration of visible lights tells an operator the size, direction of travel and means of propulsion (sail, power, rowing or at anchor) of another vessel.

This helps both operators determine who has the right of way. Larger boats are required to carry larger, brighter lights that are visible over longer distances. See the light requirement chart for pleasure craft.

MARINE SANITATION DEVICES

Recreational vessels under 65' with installed toilet facilities must have an operable marine sanitation device (MSD) on board. Vessels 65' and under may use Type I, II, or III MSD. All installed MSD's must be U.S. Coast Guard certified. Most of the devices are labeled to show conformity to the regulations.

NOTICE

DISCHARGE OF OIL PROHIBITED

THE FEDERAL WATER POLLUTION CONTROL ACT PROHIBITS THE DISCHARGE OF OIL OR OILY WASTE INTO OR UPON THE NAVIGABLE WATERS AND CONTIGUOUS ZONE OF THE UNITED STATES IF SUCH DISCHARGE CAUSES A FILM OR SHEEN UPON, OR DISCOLORATION OF THE SURFACE OF THE WATER, OR CAUSES A SLUDGE OR EMULSION BENEATH THE SURFACE OF THE WATER.

**VIOLATORS ARE SUBJECT TO
A PENALTY OF \$5,000**

Safety On Board

NAVIGATION LIGHT RULES

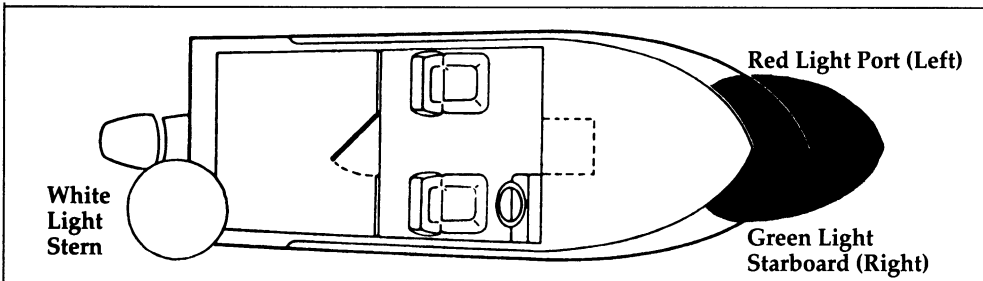

Location of lights on vessel	Visible Range		Degrees of arc lights
	Less than 12 m.	12 m. but less than 20 m.	
Masthead	2	3	225°
All-round	2	2	360°
Side lights	1	2	112.5° each color
Stern light	2	2	135°

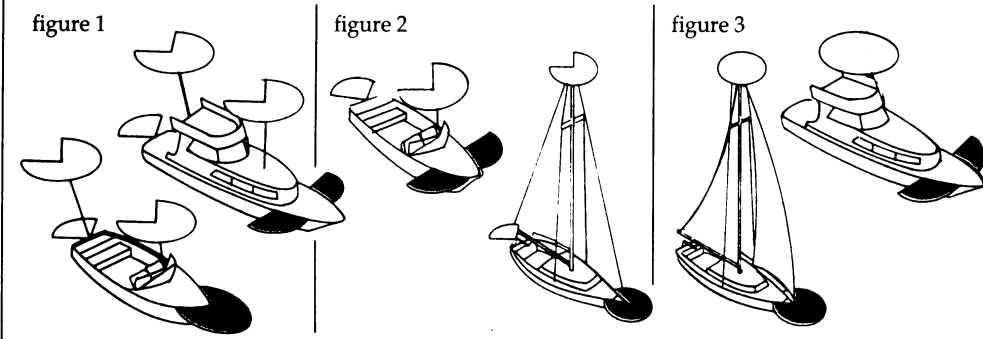

Boats less than 12 meters in length
Motorboats or sailboats using power: The lighting arrangements to figure 1, 2 or 3 may be used.
Sailboat using sails alone: The lighting arrangements in figure 4, 5 or 6 may be used.

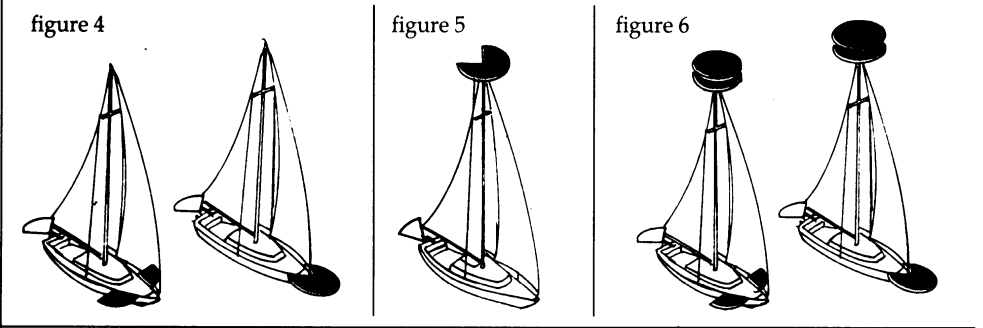

Boats 12 meters but less than 20 meters in length
Motorboats or sailboats using power: The lighting arrangements to figure 1 or 2 may be used.
Sailboat using sails alone: The lighting arrangements in figure 4, 5 or 6 may be used.

Location of lights
 Lights should be located as shown in the drawings.
 The masthead light (forward white light in figures 1, 2 and 7d) must be at least one meter higher than the colored lights on a boat less than 12 meters in length and at least 2.5 meters above the gunwale on a boat 12 meters but less than 20 meters in length.

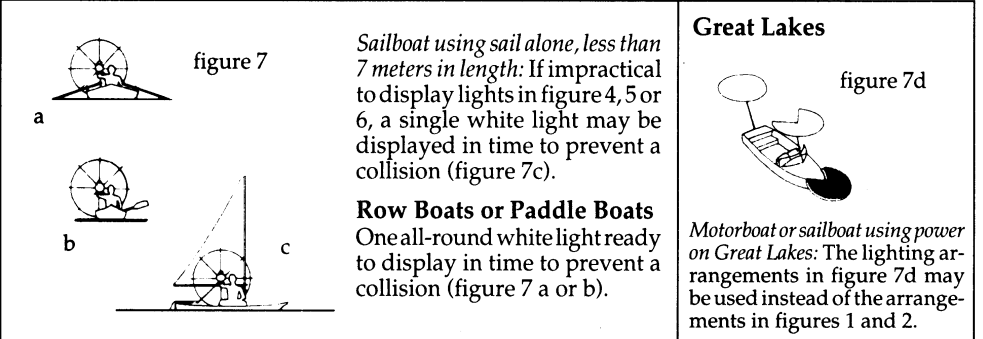

Exceptions
Motorboat or sailboat using power, built before December 24, 1980: The lighting arrangement in figure 1, 2 or 3 may be used. However, the arrangement in figure 3 is not acceptable on a boat that is 12 meters or longer on international waters.



You must immediately notify the U. S. Coast Guard if your vessel discharges oil or hazardous substances in the water. Call toll free 800-424-8802. Report the following information: location, source, size, color, substances and time observed.

GARBAGE

The Act to Prevent Pollution from Ships places limitations on the discharge of garbage from vessels. It is illegal to dump plastic trash anywhere in the ocean or navigable waters of the United States. Also, it is illegal to discharge garbage in the navigable waters of the United States, including the Great Lakes. The discharge of other types of garbage is allowed outside certain specified distances from shore as determined by the nature of that garbage. United States vessels of 26 feet or longer must display in a prominent location, a durable placard at least 4" x 9" notifying crew and passengers of discharge restrictions.

EBIRB

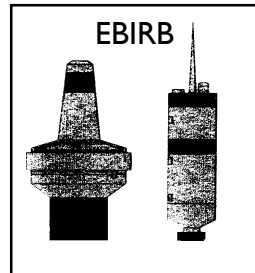

It is a good idea to carry communication gear such as a VHF-FM and/or HF transceivers set up for your operating area. Also, cell phones are useful in many coastal areas. Be sure to carry extra batteries. Also, mainly for offshore vessels, EPIRBs are

designed to quickly and accurately alert rescue forces, indicate an accurate distress position, and guide units to the distress scene. These devices operate from satellite signals sent to a ground station where the signal is downloaded. The downside is that they are relatively expensive but they are reliable even when other types of communications have been exhausted.

GARBAGE TYPE	DISCHARGE
Plastics including synthetic ropes, fishing nets, and plastic bags	Prohibited in all areas
Floating dunnage, lining and packing materials	Prohibited less than 25 miles from nearest land
Food, waste, paper bags, rags, glass, metal, bottles and crockery	Prohibited less than 12 miles from nearest land
Comminuted or ground food waste, paper, rags, glass, etc.	Prohibited less than 3 miles from the nearest land

Safety On Board

LIFE RAFTS

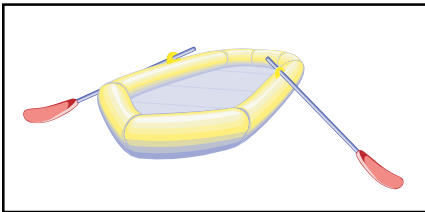

Inflatable life rafts are recommended for ocean going vessels and operating boats in large bodies of water like the

Great Lakes. They provide a shelter for extended periods. Make sure it is large enough for all aboard and contains the proper emergency equipment pack. Most life rafts are sold by a persons rating. Store the unit on board with easy access in emergency situations. Also, maintain yearly service on the unit. Make sure the life raft is Coast Guard approved.

USCG MINIMUM EQUIPMENT REQUIREMENTS

Use the chart below as a guideline for assuring your vessel is outfitted to meet the USCG standards. Remember to check the local and state authorities for additional equipment requirements. Make sure your vessel and trailer registration paperwork and numbers on the boat are up to date and displayed properly according to state requirements. Keep the paperwork on board in a watertight and safe environment . Make sure it is quickly accessible.

USCG Minimum Equipment Requirements for Recreational Vessels					
Boat Size in Feet	16'	26'	40'	65'	165'
Personal Flotation Devices¹	One Type I, II, III, or V per person		One Type I, II, III, or V per person plus one Type IV throwable		
Fire Extinguishers²	One B-I, any type		One B-II or Two B-I	One B-II and one B-I, or three B-I	One or more B-II (vessels 0-50 tons gross) Two or more B-II (vessels 50-100 tons gross)
No Fixed System					
With Fixed System	No Portables Required		One B-I	Two B-I or one Class B-II	
Visual Distress Signals	Night signals required when operating at night		Minimum of three day-use and three night-use (or three day/night combination) pyrotechnic devices ⁵		
Sound Producing Devices	Horn or whistle recommended to signal intentions or signal position		One bell, and one whistle or horn required to signal intentions or position		
Backfire Flame Arrestor	One CG-approved device on each carburetor of all gasoline-powered engines built after April 1940, except outboard motors				
Ventilation	CG standard system required on gasoline powered vessels with enclosed engine compartments built after August 1980				
Navigation Lights					
Under Power ^{3,4}	Sidelights, Stern Light and Masthead ^{6,7}				
Under Sail	Sidelights and Stern Light ^{6,8}				
Rowing	Same as "Under Sail"				
At Anchor	All-round light, 2nm (at night) or black anchoring ball (during the day) when outside a designated anchorage				
Visibility Range	1nm Sidelights, 2nm all others		3nm Masthead, 2nm all others		5nm Masthead, 2nm all others
Pollution Regulations	"Honor system" (no plaques required)		5" x 8" Oil Discharge placard and 4" x 9" Waste Discharge placard		
Marine Sanitation Devices	Vessels with installed toilet facilities must have an operable, CG-certified Type I, II or III Marine Sanitation Device (MSD). Subject to local laws!		Vessels over 40' with a galley must have a Waste Management Plan		
Navigation Rules	Familiarity with the Inland Navigation Rules required		The Inland Navigation Rules ("Rules of the Road") must be kept on board		

<ol style="list-style-type: none"> 1. Pfd's must be CG approved, wearable by the intended user and readily accessible. 2. Fire extinguishers required on boats with enclosed engine compartments (not outboards), enclosed living spaces or permanent fuel tanks. 3. Sailboats operating under engine power are considered power driven and must follow the "Under Power" rules. During the day, motorsailing vessels are required to fly a motoring cone. 4. Power-driven vessels under 23' and under 7 knots can substitute a white lantern or torch in place of the required lights. 	<ol style="list-style-type: none"> 5. Non-pyrotechnic substitutes: 1 orange distress flag (day-use) and 1 electric SOS signal light (night-use). 6. All boats under 65' can substitute a single bi-color light for sidelights. 7. Boats under power under 40' can substitute a single all-round light for separate stern and masthead lights. 8. Boats under sail under 40' can substitute a tri-color light for separate sidelights and stern light.
---	---

Additions to these requirements are prescribed by some individual state laws. Check your state's Boating Safety Handbook for a complete list.



EXHAUST & CARBON MONOXIDE

Carbon monoxide(CO) in exhaust can be hazardous. It is important for you and your passengers to be aware of the potential safety hazard created by exhaust gases. Familiarize yourself with the symptoms of carbon monoxide poisoning.

For safety sake avoid the following:

1. Do not allow the boat to remain stationary with the engine idling for an extended period of time.
2. Do not disable the carbon monoxide alarms that come with your Regal boat. Test the unit in accordance with the alarm manufacturers instructions.
3. Do not operate the engine for extended periods of time while in a confined area or where exhaust outlets face a wall or bulkhead.
4. Do not operate the engine for an extended period of time with the canvas in the upright and installed position.
5. Have the engine exhaust system inspected when the boat is in for service.
6. Persons sleeping can easily be overcome by carbon monoxide without realizing it. Do not sleep on board while the engine is running.

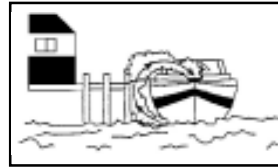

doors are open.

Blockage of exhaust outlets can cause carbon monoxide to accumulate in the cabin and cockpit area even when the hatches, windows, portholes and

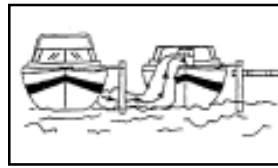

Exhaust from another vessel alongside your boat, while docked or anchored, can emit poisonous CO gas inside the cabin and cockpit areas of your boat.



The “station wagon effect” or backdrafting can cause CO gas to accumulate inside the cabin, cockpit or bridge areas when the boat is under-way, using protective weather coverings, high bow angle, improper or heavy loading, slow speeds, or when boat is at rest.

In high concentrations, CO can be fatal in minutes. However, the effects of lower concentrations over a extended period of time can be just as lethal.

Carbon Monoxide accumulation requires immediate attention! Thoroughly ventilate cabin and cockpit areas. Determine the probable source of the carbon monoxide and correct the condition immediately. Regal has installed CO detectors on your boat. Have these detectors professionally calibrated at regular intervals.

Symptoms of excessive exposure to carbon monoxide are:

- Dizziness
- Drowsiness
- Nausea
- Headache
- Ringing in the ears
- Throbbing temples
- Watering, itchy eyes
- Flushed appearance
- Inattentiveness
- Incoherence
- Fatigue or vomiting
- Convulsions

WARNING

**AVOID SERIOUS INJURY OR DEATH
FROM CO POISONING!**

**DO NOT OPERATE THE BOAT WITH PEOPLE
HOLDING ON TO THE SWIM PLATFORM
WHILE IN THE WATER.**

Safety On Board

CARBON MONOXIDE LABEL-HELM

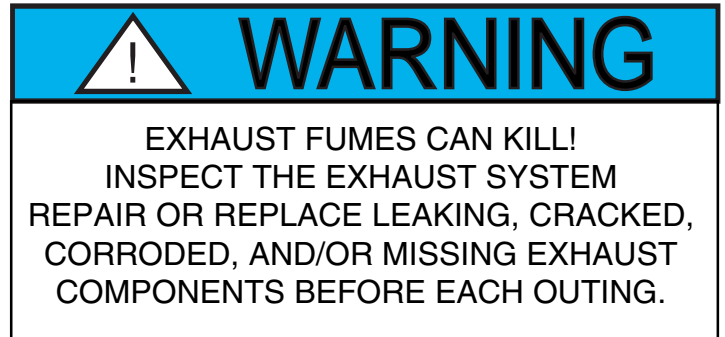
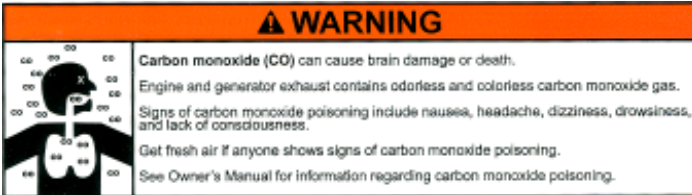

CARBON MONOXIDE LABEL-TRANSOM

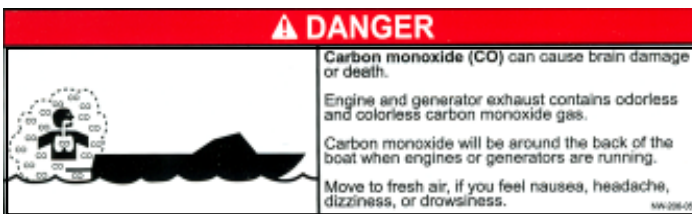

EACH TRIP

- Make sure all exhaust clamps are in place and secure.
- Look for exhaust leaking from the exhaust system components, indicated by rust and or black streaking, water leaks, or corroded or cracked fittings.
- Inspect all rubber exhaust hoses for burned or cracked areas. All rubber hoses should feel soft and and be free of kinks.
- Visually verify that water exits at the engine exhaust outlet.
- Keep an ear tuned for any change in exhaust sound that could indicate an exhaust component malfunction.

CARBON MONOXIDE LABEL-CABIN /HEAD

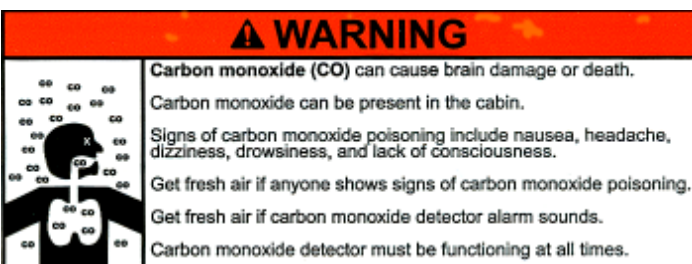

DO NOT OPERATE THE VESSEL IF ANY OF THE ABOVE ITEMS EXIST. CONTACT A MARINE PROFESSIONAL!

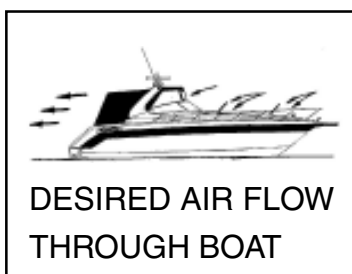

To help prevent carbon monoxide accumulation, ventilate your cabin and cockpit while underway. Open a forward hatch, porthole or window to allow air to travel through the boat's interior. Never

cruise with the canvas installed.



At Least Annually (To be performed by a marine professional);

- ☑ Replace exhaust hoses or mufflers if any evidence of cracking, charring or deterioration is found.
- ☑ Replace the engine water pump impeller along with the plate and housing if necessary. This will help prevent cooling system and in turn exhaust system overheating.
- ☑ Inspect each of the metallic exhaust components for cracking, rusting, leaking or looseness. Pay detailed attention to the exhaust manifold, cylinder head, water injection elbows.

BOATING & ALCOHOL

 **WARNING**

**FEDERAL LAWS PROHIBIT OPERATING
A VESSEL UNDER THE INFLUENCE OF
ALCOHOL OR DRUGS.
THESE LAWS ARE VIGOROUSLY
ENFORCED BY ALL LOCAL, STATE AND
FEDERAL AGENCIES.**

Operating a vessel while intoxicated became a specific federal offense effective in 1988. The ruling set federal standards for determining when an individual is intoxicated. If the blood alcohol content (BAC) is .10% (.08 in some states) or higher for operators of recreational vessels being used only for pleasure are subject to a civil penalty up to \$1,000 or criminal penalty up to \$5,000, one year imprisonment or both. In some states the fines and imprisonment may increase significantly.

The effects of alcohol and drugs account for the highest single cause of marine accidents and deaths. Most deaths in boating accidents occur when someone falls into the water. Balance is one of the first things you lose when drinking alcohol or under the influence of drugs. The problem arises out of not knowing your balance is restricted.

Overall vision is reduced by alcohol especially at night, along with double or blurred vision. Peripheral vision is lessened which restricts seeing vessels or objects on the side. Also, color awareness decreases especially with red and green which happen to be the colors of boat navigation lights, buoys, and channel markers.

Alcohol will greatly increase your heat loss so it increases the effects of hypothermia. Finally, your ability to make correct judgements in emergency situations is greatly reduced. Alcohol takes away the brains ability to process information quickly and delays a persons reaction time.

Don't drink and drive!

Safety On Board

ALCOHOL MYTHS AND FACTS

Myth: Beer is less intoxicating than other alcoholic beverages.

Fact: One 12 oz. can of beer has about the same amount of alcohol as a 5oz. glass of wine or a shot of liquor.

Myth: Black coffee, fresh air, and a shower will sober the effects of alcohol.

Fact: After consuming alcohol time is the only thing that will sober you up. Our bodies average burning 1 oz. of alcohol every hour. If a person is drunk, it will take a person seven or more hours to sober up.

Myth: Telling if a person is too drunk to operate a vessel is easy.

Fact: Many experienced drinkers have learned to compensate for the visual effects of alcohol and can disguise their drunk condition.

Myth: You can judge if you are fit to operate a boat.

Fact: Judgement is one of the first elements you lose when drinking.

BOATING ACCIDENTS

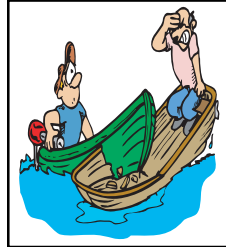

The following is a list of common causes of boating accidents. Be aware of them and take the necessary steps to ensure that yourself and crew are educated and prepared to act in an emergency.

- ◆ Mixing boating and alcohol. Remember the skipper is responsible for his boat and crew.
- ◆ Trying to reach the bow by the deck walk-around while the boat is moving too fast.
- ◆ Someone sitting on the bow, deck, or swim platform while underway.
- ◆ Choosing a boating outing day with inclement weather, especially with high winds and thunderstorms in the forecast or staying out when bad weather is approaching.
- ◆ Disembarking without checking all fluids or systems, and especially fuel system components.
- ◆ Not monitoring the boating traffic or possible obstructions around you.
- ◆ Emergency communications equipment, signaling devices, and navigation lights not working.



- ◆ Improper boat handling especially high speed turns in rough water. Improper trim.
- ◆ Being too far from shore with inadequate fuel supply or navigational aids..
- ◆ Passengers, especially children that are not wearing the proper life saving devices.
- ◆ Skipper or passengers not seated in the boat.
- ◆ Running a craft that is mechanically marginal.

REPORTING BOATING ACCIDENTS

According to the Federal Boat Safety Act of 1971 involving collision, accident or other casualty, the operator must make a formal report within 48 hours to the nearest state boating authority when the incident involves:

1. Death
2. Injury requiring treatment other than first aid
3. The disappearance of someone from a boat under death or injury circumstances.

A formal report must be made within 10 days for accidents involving more than \$500 damage or complete loss of vessel.

For information regarding accident reporting, please call the **Boating Safety Hotline** at 800-368-5647.

RENDERING ASSISTANCE

The operator of a vessel is obligated by law to provide assistance that can be provided safely to any individuals in dangerous situation on the waterways. The operator is subject to fine and or imprisonment for failure to do so. Move cautiously and think before acting.

	DANGER
<p>AVOID BODILY INJURY OR DEATH! TO AVOID FALLING STAY SEATED IN THE COCKPIT WHILE THE BOAT IS RUNNING .</p>	

Safety On Board

WATER SPORTS

Besides learning the safety precautions for safe boating, as well as understanding and knowing required rules and regulations, you are obligated to be particularly careful around other water sportsman, such as scuba divers, water skiers, wake boarders, and fisherman.

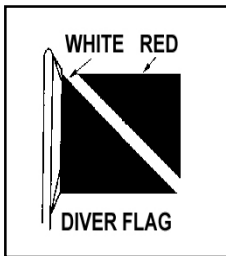

Whenever you see a “Diver Down” flag, maintain a distance of at least 100 feet on inland waters. In bays and open waters stay 300 feet away. The flag indicates a diver in the water. If a diver is operating from your boat, be certain to use this flag and post a lookout on board to observe the

divers air bubbles.

SWIM PLATFORM

On integrated or extended swim platforms you should make periodic inspections of the swim ladder and hardware that supports the platform to ensure that all connections and fittings are tight and in good condition. When fishing from your boat, never anchor in a shipping channel or tie up to any navigational aids. These must be kept clear of at all times. Use heed when operating the boat in reverse to

insure that water does not accumulate excessively on the platform or transom, especially in rough seas or strong currents. **Do not exceed the platform recommended maximum capacity label!** Typical label shown above.

WARNING!
MAXIMUM CAPACITY
OF SWIM PLATFORM
750 POUNDS
226 KG

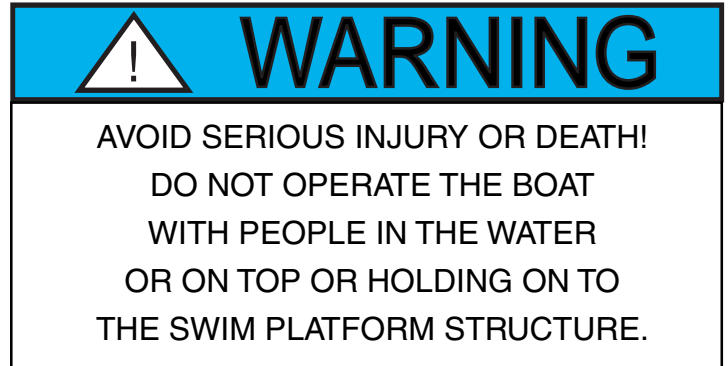

FISHING



Most boaters fish from time to time. With the propulsion systems of today it is possible to fish in out-of-the-way places. When cruising, stay clear of fisherman. They may have lines or nets out which might be cut or get caught in your propeller if you come too close. Slow down when

approaching fishing boats.

Do not return to cruising speed until the boats have been passed. If a fishing boat should be anchored, a large wake could flip or swamp the boat, upset fishing gear, pull the anchor loose from the bottom or worse yet cause someone to fall overboard.

Do not return to cruising speed until the boats have been passed. If a fishing boat should be anchored, a large wake could flip or swamp the boat, upset fishing gear, pull the anchor loose from the bottom or worse yet cause someone to fall overboard.

When fishing from your boat, never anchor in shipping channel or tie up to any navigational aids. These must be kept clear of at all times.

Be sure to carry a chart of the area and be on the lookout for shallow water and hidden obstructions. Pick up a local tidal chart if appropriate so you do not end up grounded.



WEATHER & WATER CONDITIONS

Before a boating outing check the weather conditions. As we all know the weather can change rapidly in many parts of the country. It does so sometimes without being predicted. NOAA weather radio reports are continuously available on designated frequencies installed on VHF radios and various handhelds. Also, many local radio stations carry weather reports .

CLOUD FORMATIONS

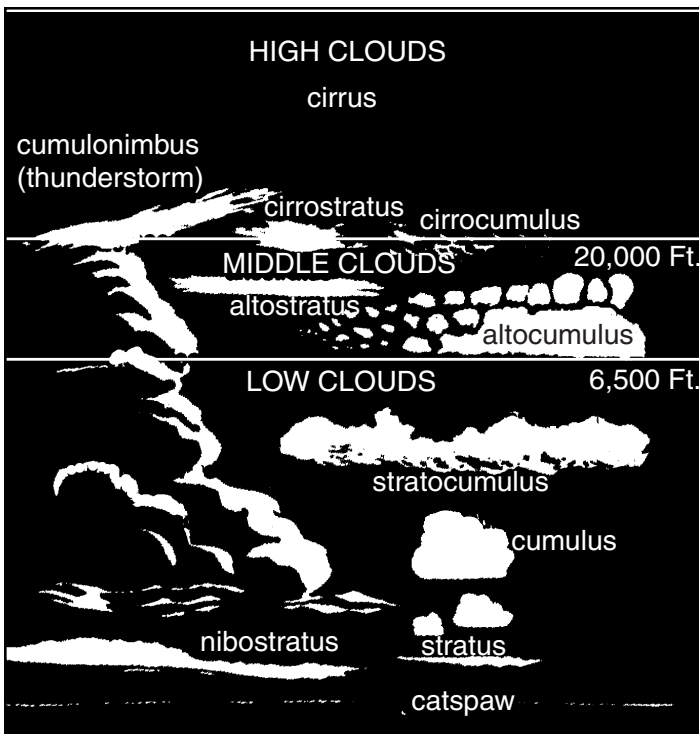

Clouds indicate the type of current weather and upcoming changes in the weather. Knowing the type of cloud formations can assist you in choosing the appropriate boating day or if already on the water will help you understand any upcoming weather changes. Flat clouds (stratus) normally indicate stable air. Cumulus clouds indicate unstable air. Often a “cottonball” or cumulus cloud builds vertical height in the afternoon and the result is a thunderstorm with increased winds and waves; sometimes these storms are quite violent. You can find additional information on weather (meteorology) at your local library.

WAVES & FOG



As the wind blows across water waves are created. The stronger the wind and increased distance across the water enlarges the wave action.

Other factors that can cause problem situations for vessels are fog, currents, and tidal changes.

Fog can develop inland on clear, calm mornings. Coastal areas see large “blankets” of fog roll in and stay for extended time periods causing sometimes hazardous navigation conditions. If you are caught in the fog, do not panic. Think of the best plan of action and proceed carefully. If you are limited in navigation equipment **at the first sign of fog** proceed to the nearest shoreline and wait until the fog lifts.







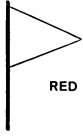

Boats equipped with navigation equipment, local waterway experience and charts should proceed to a safe harbor. Use extreme caution, signal as needed, and reduce to a speed where you can stop within half of your forward vision range.

If foul weather catches you at sea do the following:

1. Slow down. Proceed with caution and put on your life vests.
2. Try to reach the nearest safe shoreline.
3. Navigate your vessel slowly into the waves at a 45 degree angle.
4. Passengers should sit low in the center of the vessel.
5. Monitor your bilge pump. Make sure sump stays free of water.
6. Secure loose gear. Make ready emergency equipment.
7. If the engine stops, throw the anchor over the bow. If needed use a sea anchor. Never anchor off the stern.

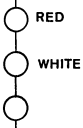
Safety On Board

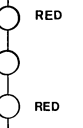
MARINE WEATHER SYMBOLS

	SMALL CRAFT	GALE	STORM	HURRICANE
DAY FLAGS	 RED	 RED	 RED & BLACK	 RED & BLACK
NIGHT LIGHTS	 RED WHITE RED	 RED WHITE RED	 RED WHITE RED	 RED WHITE RED

Although the National Weather Service has discontinued the use of the day flags and night lights, many marinas and ports of call still use them.



Notes

Rules Of The Road

NAVIGATION RULES DEFINED

The Navigation Rules set forth actions to be followed by boats to avoid collision. They are referred to as the “Rules of the Road”. There are two main parts referred to as the inland and international rules. The inland rules apply to vessels operating inside the boundaries of the United States. The international rules (referred to as COLREGS) apply to vessels operating on the high seas and all connected waters outside the established demarcation boundaries. Most navigational charts show the demarcation lines by red dotted lines and are published in the navigation rules. Remember to consult state and local agencies since areas such as “no wake zones”, swimming beaches, “diver down flag” and inland landlocked lakes fall under their jurisdiction. This section is only an introduction to the “rules of the road”. We strongly recommend additional training before getting behind the “wheel” of your boat.

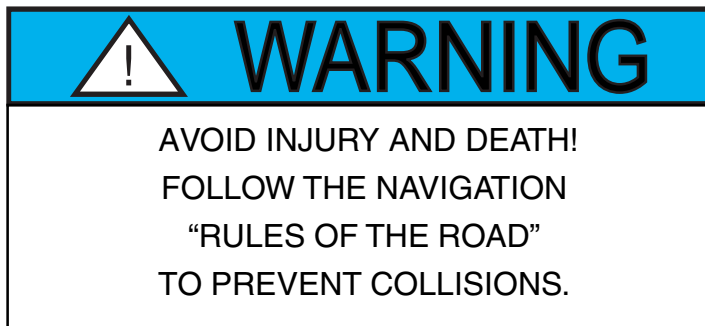

You can order the Inland & International Navigation Rules from:
Superintendent of Documents
U. S. Government Printing Office
Washington, DC 20402
Tel: (202-512-1800) Fax:(202-512-2250)

NAVIGATION RULES

RIGHT OF WAY

1. Cross waves at right angles.
2. When caught in heavy water or squalls, head either directly into the waves or at a slight angle. Reduce speed, but maintain enough power to maneuver your boat safely.
3. Keep your speed under control. Respect the rights of other boaters engaged in all water sports. Give them a “wide berth”.
4. Whenever meeting a boat head on, keep to the right where possible.
5. When two boats cross, the boat to the right (starboard) has the right of way.



6. When overtaking or passing, the boat being passed has the right of way.

In general, boats with less maneuverability have right-of-way over more agile craft. The skipper must keep his craft clear of the following vessels:

- A vessel not under command or aground; due to their circumstances, these vessels have no maneuverability.
- A vessel restricted in its maneuverability; these vessels usually are performing work which limits their maneuverability such as surveying, dredging, laying pipe or cable, or servicing navigational markers among others.
- A vessel engaged in fishing; these include boats fishing with lines, trawls or nets, but not trolling lines.
- Sailboats; they have the right-of-way over powerboats. However, if a sailboat is using a prop to move forward, it is considered a powerboat even if the sails are up.
- Remember the unwritten “rule of tonnage”. Basically a smaller tonnage vessel should take every effort to avoid close quarters with a larger tonnage vessel. One way to accomplish this is to have a designated human lookout to “eyeball” the horizon for any developing collision course.
- Use defensive driving skills on the waterway just as you do on the roadway. The other vessel may not know the “rules of the road” Be alert and ready to take immediate action.
- If a collision course is unavoidable neither boat has the right of way. Both boats must react to avoid an accident according to the rules of the road.

WHISTLE SIGNALS

- ONE LONG BLAST:** Warning signal
(Coming out of slip)
- ONE SHORT BLAST:** Pass on my port side
- TWO SHORT BLASTS:** Pass on my starboard side
- THREE SHORT BLASTS:** Engine(s) in reverse
- FOUR OR MORE BLASTS:** Danger signal

BRIDGE SIGNALS

		DAY (Flag)	NIGHT (Lights)
SOUND			
VESSEL: Open	—●	↑	↑
BRIDGE: OK	—●	↓	↓
No	●●●●●	or	or
VESSEL: Replies:	●●●●●	Same	Same
RADIO: VHF CH. 13		No	←●→

Rules Of The Road

NAVIGATION RULES

The Navigation Rules set forth 3 types of crossing situations- crossing, meeting, and overtaking. In each case, both boats are governed by special procedures.

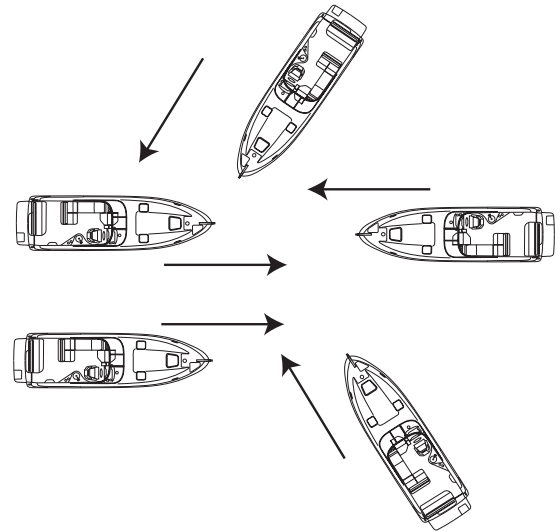

In a head-on meeting, both vessels must sound a single blast to give way toward starboard and pass to port.

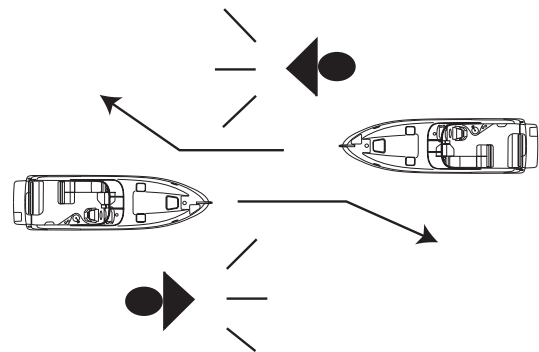

These rules appear when there is a risk of collision. In a crossing situation be aware of the other craft's position. For safety, there should be a noticeable change in the angle, bow or stern; a gradual change in position indicates possible danger.

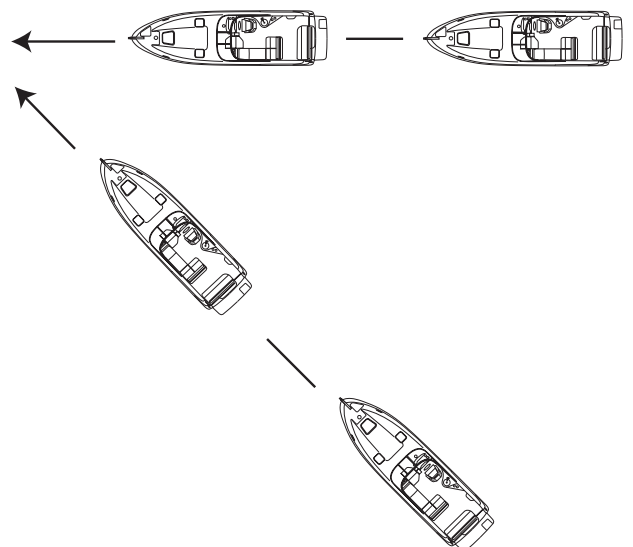



NAVIGATION RULES

An overtaking boat is burdened, and is not the privileged craft, even though it approaches the danger zone of the overtaken boat.

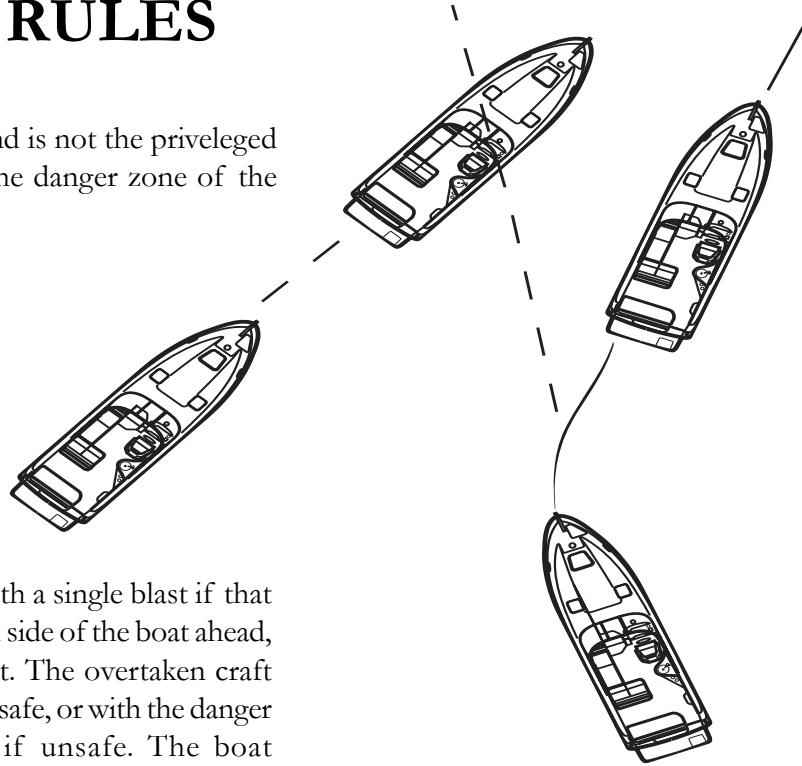

The overtaking boat first signals with a single blast if that boat desires to pass on the starboard side of the boat ahead, or a double blast if passing to port. The overtaken craft responds with the same signal if it is safe, or with the danger signal (5 short blasts or more) if unsafe. The boat overtaking must not pass unless the appropriate signals are sounded.

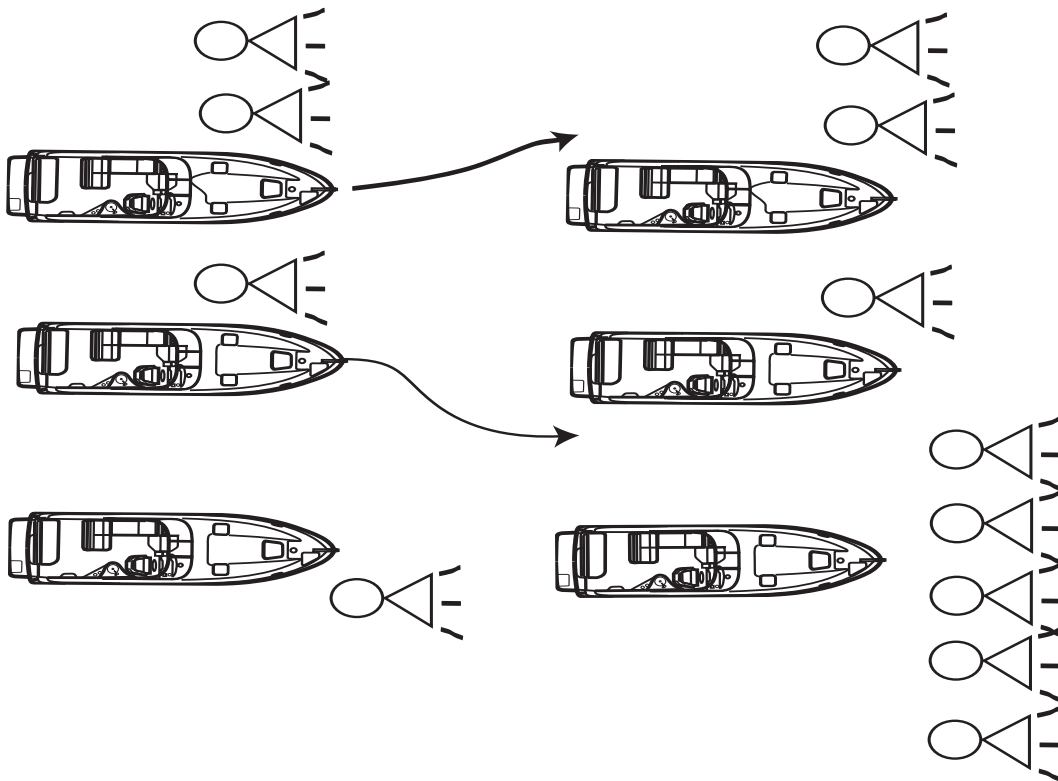

Rules Of The Road

NAVIGATION AIDS

Navigation aids are placed along coasts and navigable waters as a guide for mariners in determining their position in reference to land and hidden danger. Each aid provides specific information. They form a continuous system of charted markers for accurate piloting on paper and on the water.

Nautical charts are provided by the National Ocean Service (NOS) and are distributed nationwide through marinas and outlet stores. These charts show the geography of the coast, water depth, landmarks, navigation aids (buoys and markers), marine hazards, and port facilities. Use only up-to-date charts for navigation. We recommend when purchasing a chart to look for the weather resistant ones. Buoys provide a roadmap to keep the skipper on course and to avoid hazards. Buoys are identified by light, shape, color and in severe weather conditions by sound.

Buoys or beacons called lateral markers indicate the port and starboard sides of the waterway to be followed. U. S markers follow the buoyage system known as Red Right Returning. When returning from sea or traveling upstream, the green markers are to port (on your left) and the red markers are to the starboard side (on your right). When traveling downstream or out to sea the marker color would be reversed.

Before operating your vessel, learn to identify the various navigational aids such as lateral aids, mid-channel markers, information and regulatory markers.

NOTICE

SKIPPERS MUST NOT RELY ON BUOYS
ALONE TO MARK THEIR POSITION.
SEVERE WEATHER CONDITIONS
AND WAVE ACTION CAN ALTER
A BUOYS POSITION.
NEVER TIE UP TO A BUOY.
IT IS ILLEGAL AND DANGEROUS.



LATERAL AIDS

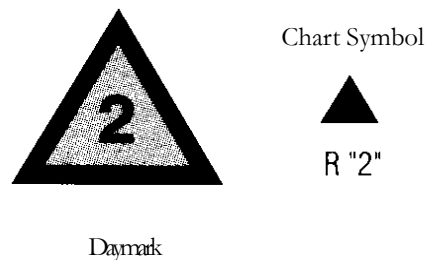
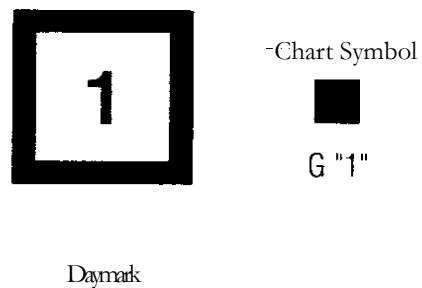
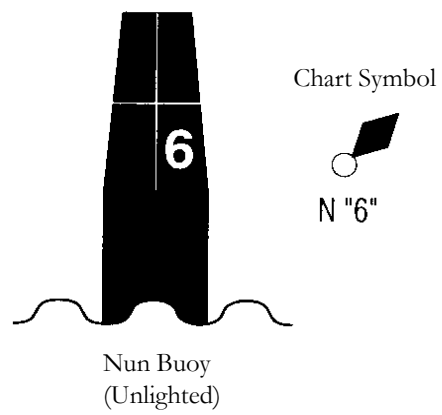
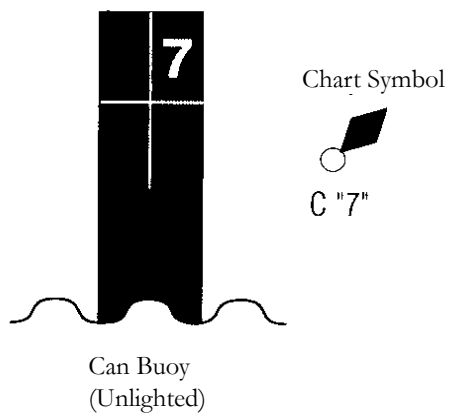
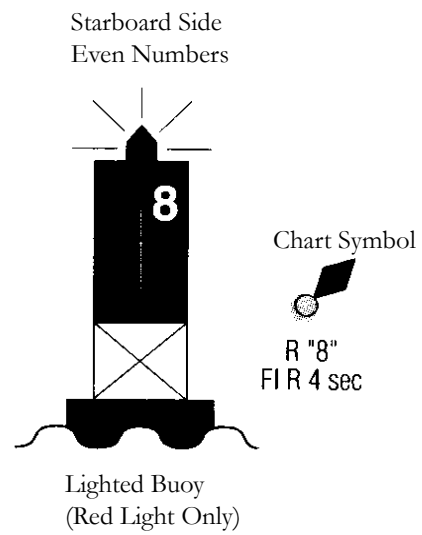
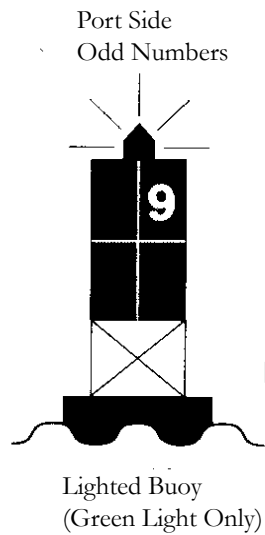

Rules Of The Road

MID-CHANNEL MARKERS

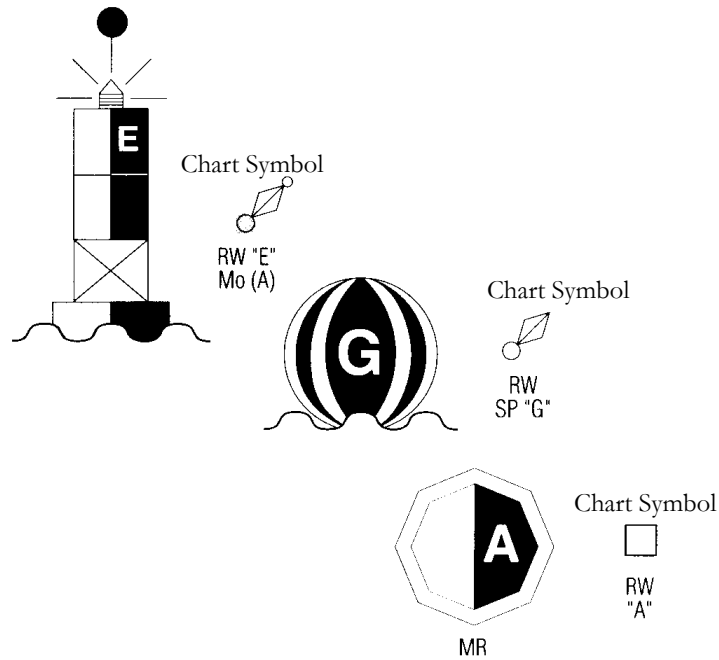

REGULATORY MARKERS

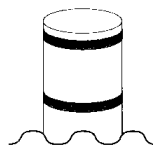

Diamond Shape
Warns Of Danger



Diamond Shape With Cross-
Boats Keep Out



Circle Marks Area Controlled
As Indicated .



For showing information such as
locations, distances and directions



NIGHT RUNNING

Boats operating between sunset and sunrise (hours vary by state), or in conditions of reduced visibility, must use navigation lights. Nighttime operation, especially during bad weather and fog can be dangerous. All Rules of the Road apply at night, but it is best to slow down and stay clear of all boats regardless of who has the right-of-way. To see more easily at night, avoid bright lights when possible. Also, it is helpful to have a passenger keep watch for other boats, water hazards and navigational aids.

To determine the size, speed and direction of other vessels at night, you should use the running lights. A green light indicates starboard side, and a red light indicates port side. Generally, if you see a green light, you have the right-of-way. If you see a red light, give way to the other vessel.

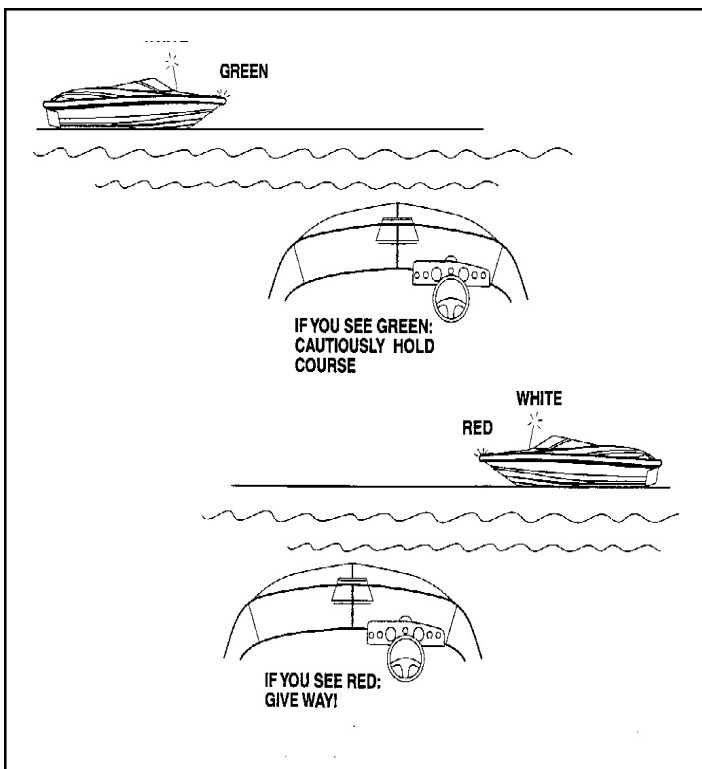

BRIDGE CLEARANCE

Be aware that your vessel requires a specified bridge clearance height. This height is a measured estimate from the waterline to the top of the highest object usually the radar arch, radar or the masthead light depending on what arch equipment is installed. The estimated height can change because of variances in the loaded condition of the vessel. Consult the bridge clearance specifications located in Chapter 12 (technical information section). An easy way to measure bridge clearance is to have someone place a long straightedge such as a piece of wood at a 90 degree angle across the highest point of the boat. Then with a tape rule measure the distance straight down to the waterline. Take this measurement with the fuel and water tanks 1/2 full and only 1 person besides yourself on board. This will give you a safe measurement. As your boat is loaded down with people the bridge clearance will become somewhat lower.

Some bridges are tendered. Know and use the proper bridge signals when approaching these bridges (see bridge signals in this chapter). You can also monitor and communicate on channel 13 of a VHF radio for bridge information in most domestic locals. Other bridges are marked with a clearance measurement and you are on your own. After determining your vessel will clear the bridge proceed with caution at a safe idle speed. Keep your eye on vessel traffic at all times in order to react quickly. Resume a safe speed once clear of the bridge structure and acknowledgment of clear visibility.

Use common sense regarding bridge clearance because bodily injury and property damage could result if a mishap occurs with a bridge structure.

Engines & Controls

ENGINES

MANUFACTURER'S MANUALS

It is important that you read the manufacturer's engine manual carefully and become completely familiar with the operation as well as necessary maintenance on the engine and propulsion systems. Your Regal dealer has been factory trained on Regal boat systems. Consult your Regal dealer for further information regarding technical issues and parts. Use only approved marine replacement parts.

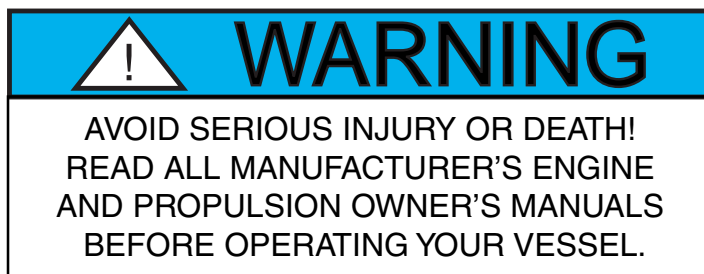

ENGINE MOUNTS

The engine is placed in the boat on a set of metal or wooden platforms called mounts. These rubber isolation mounts keep the engine from moving laterally and athwartships (right angles to the center line). The mounts help reduce the vibration caused by the engine and drive. Periodically, the mount hardware should be checked for tightness.

ENGINE ALIGNMENT

Select stern drives use a rubber splined hub to which the stern drive shaft is attached. There is an alignment specification between the engine and outdrive that needs to be checked periodically. A special alignment shaft is greased at the tip and inserted through the gimbal housing. The alignment angle can be determined by the spline image left on the tool. The engine mounts are then adjusted to permit a similar spline image 360 degrees around the greased alignment tool. This specification should be checked after each 50 hours of operation or if the vessel has run aground or hit a submerged object. Alignment should be checked by a Regal dealer or marine professional since a special tool and procedure is required.

ENGINE REMOVAL

In the event the engine requires major service and needs to be removed, consult your Regal dealer. The dealer possesses the knowledge and factory training necessary to accomplish such a job. Do not undertake this type of repair yourself as there can be major safety, technical and possibly warranty implications.



ENGINE VENTILATION

Ventilation systems are required for gasoline engine compartments. Your boat features a set of deck vent shrouds which supply a constant amount of air to the engine compartment. A powered blower motor (s) connected to ducts in the lower one third of the bilge evacuates contaminated air to the atmosphere. Understand the following warning.

	WARNING
<p>GASOLINE VAPORS CAN EXPLODE! BEFORE STARTING ENGINE(S) OPERATE BLOWER(S) 4 MINUTES AND CHECK ENGINE COMPARTMENT FOR GASOLINE LEAKS AND VAPORS. RUN BLOWER(S) BELOW CRUISING SPEED.</p>	

INTAKE & EXHAUST VENTILATION DUCTS

Check the intake and exhaust (ducts) vents periodically for debris build up. They are located on both aft sides of the deck. See photo. When in the bilge make sure you do not step on the black bilge blower hoses. Ensure that the hose runs are sloped downward to prevent any water trapping.



PROPULSION

STERN DRIVES

It is important that you read the propulsion manufacturer's manual carefully and become familiar with the operation as well as necessary maintenance on the drive train components. Pay careful attention to the sections on winterization if you live in freezing climates. Extensive damage can result if proper winterization is not followed. Refer to the maintenance section of this manual for more information or call your nearest Regal dealer.

AUDIBLE ALARMS

Selected engines use audible alarms. They are designed to use sensors which pick up deviations from the normal operating parameters. Oil pressure and temperature sensors send a signal to a buzzer under the dash which sounds a high pitched alarm indicating a possible problem. In addition to the dash, some engines use buzzers at the engine itself. On start up it is not unusual to hear an audible alarm sound when cranking the engine over. This occurs normally because it takes a second or two to build up the engine oil pressure. Then the alarm will stop. A seasoned skipper monitors his instrument panel often while cruising.

	WARNING
<p>TO PREVENT INJURY OR DEATH USE ONLY APPROVED MARINE REPLACEMENT PARTS THAT ARE IGNITION PROTECTED.</p>	

PROPELLERS

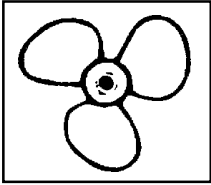

We have carefully chosen and tested the propeller(s) to give your boat the best possible performance and have allowed for the additional weight in passengers and basic equipment that might be added to the boat.

With stern drives it is a good idea to carry a spare set of propellers and hand tools in order to handle an emergency propeller change. Refer to the manufacturer's engine manual for proper procedures since each stern drive application may be different.

Call a marine professional or your Regal dealer for further information.

PROPELLER CHECKLIST

At least twice a year check the propeller for:

- Loose, missing or corroded hardware.
- Nicks, dings or missing propeller material
- Bent propeller blades.
- Objects wrapped around the prop such as fish line.
- Decomposing propeller blades (electrolysis symptom).
- Aluminum prop with paint coming off near blade tip (ventilation symptom).
- Check the propeller pressed in rubber hub for slippage.

Contact a propeller shop or your closest Regal dealer if any of the propeller checklist symptoms exist. Propeller shops have special equipment to refurbish both stainless steel and aluminum propellers. After making any blade alternations the propellers are "repitched" in special jigs.

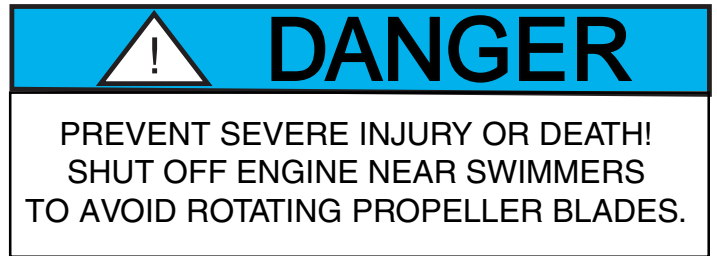

CONTROLS

INSTRUMENTATION

The helm station is equipped with a complete set of instruments that allows you to monitor the condition of the engine. Close observation of the gauges may save the engine from damage.

The dash instrument panel is powered and protected by an ignition breaker located above the key switch. The breaker protects the engine instrumentation wiring. The engine wiring itself is protected by a main breaker with a push button reset mounted on the engine. Refer to your engine manual for information on type and location. If a breaker "pops" figure out the reason why before resetting it. Each dash switch is also protected by a breaker. For an overview of the dash refer to the pictorial in this chapter.

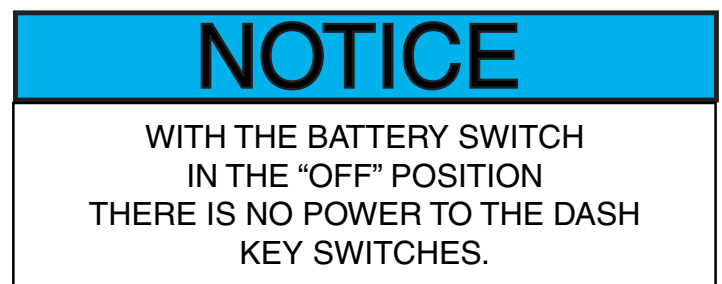



TYPICAL GAUGE OPERATION

Tachometer

The tachometer (tach) indicates the speed of the engine in revolutions per minute (rpm). Engine manufacturers use digital rev limiters to ensure engines do not exceed recommended rpms. *Select* tachometers have built in hour meters included for scheduling maintenance. See photo above. Consult your engine operation manual for suggested maintenance schedules as they are usually set up using engine hours as the main ingredient.

Trim Gauge

This gauge measures the stern drive tilt and indicates the relative position of the bow, up or down when the boat is on plane. The power trim normally begins with the drive in the down (in) position. At this point the engine is accelerated resulting in the boat assuming a plane position. At this point the trim can be adjusted for the most efficient operation for existing sea conditions. See the additional trim system information in chapter 5.

Depth Gauge

The depth gauge indicates the water depth under the keel of the boat. It features a shallow water alarm which is adjustable. By monitoring the water depth closely damage related to props and underwater hardware can be minimized.

Fuel Gauge

The fuel gauge indicates the level of fuel inside the fuel tank(s). It is a good idea to keep the fuel tank “topped off” when possible to reduce fuel vapors inside the tank. Do not run the fuel level close to empty. Figure in an adequate “safety” factor when monitoring fuel gauges since they are not entirely accurate. Use the 1/3 rule to help ensure there is plenty of fuel for the return trip.

Volt Meter

The volt meter monitors the battery condition as well as the alternator performance. Normal voltage is between 12.0 and 15.0 volts. Readings outside of this range may indicate a charging system or battery problem.

Engine & Controls



Oil Pressure

The oil pressure gauge indicates the pressure of the oil inside the engine lubrication system. A drop in oil pressure may be an indication of a low oil situation or a leak. Continued operation of the engines with low oil pressure could lead to engine damage.

Temperature Gauge

The temperature gauge monitors the cooling system of the engine. A sudden increase in the temperature could be a sign that the engine cooling system is malfunctioning. Shut down the engine immediately and investigate the problem. Consult your engine manual for allowable limits.

Automatic Fire Extinguisher

The automatic fire extinguishing system utilizes an instrument display unit (gauge) that provides the operator with a system status of charged or uncharged condition by an audible alarm (Not Shown).

With the ignition on and no light indicates the system has discharged. If the system should discharge the ignition system will be instantaneously interrupted. Should this occur shut down the engine and electrical devices. Investigate the source of the shutdown immediately and take appropriate action.

Gas Vapor Detector

If installed the gas vapor detector determines if there is a level of gasoline vapors that is unsafe in the engine room of the boat. If installed, turn on the unit and wait about one minute for it to do its safety test. A green light shows a passed safety test. You must run the test before you start the engines. In the event you don't get a green light, you must investigate the bilge of the boat for gas fumes or signs of a fuel leak before starting the engines (Not Shown).

Speedometer

Select vessel utilize a speedometer to display speed in miles per hour.



TYPICAL INSTRUMENT PANEL OVERVIEW



Depth Gauge Multi-Gauge Optional Chartplotter Tachometer Trim Gauge
Port Switch Panel Compass Stbd. Switch Panel



Blower Label
Ignition Switch
12 Volt Plug
Ignition Circuit Breaker

Engine & Controls

TYPICAL HELM OVERVIEW

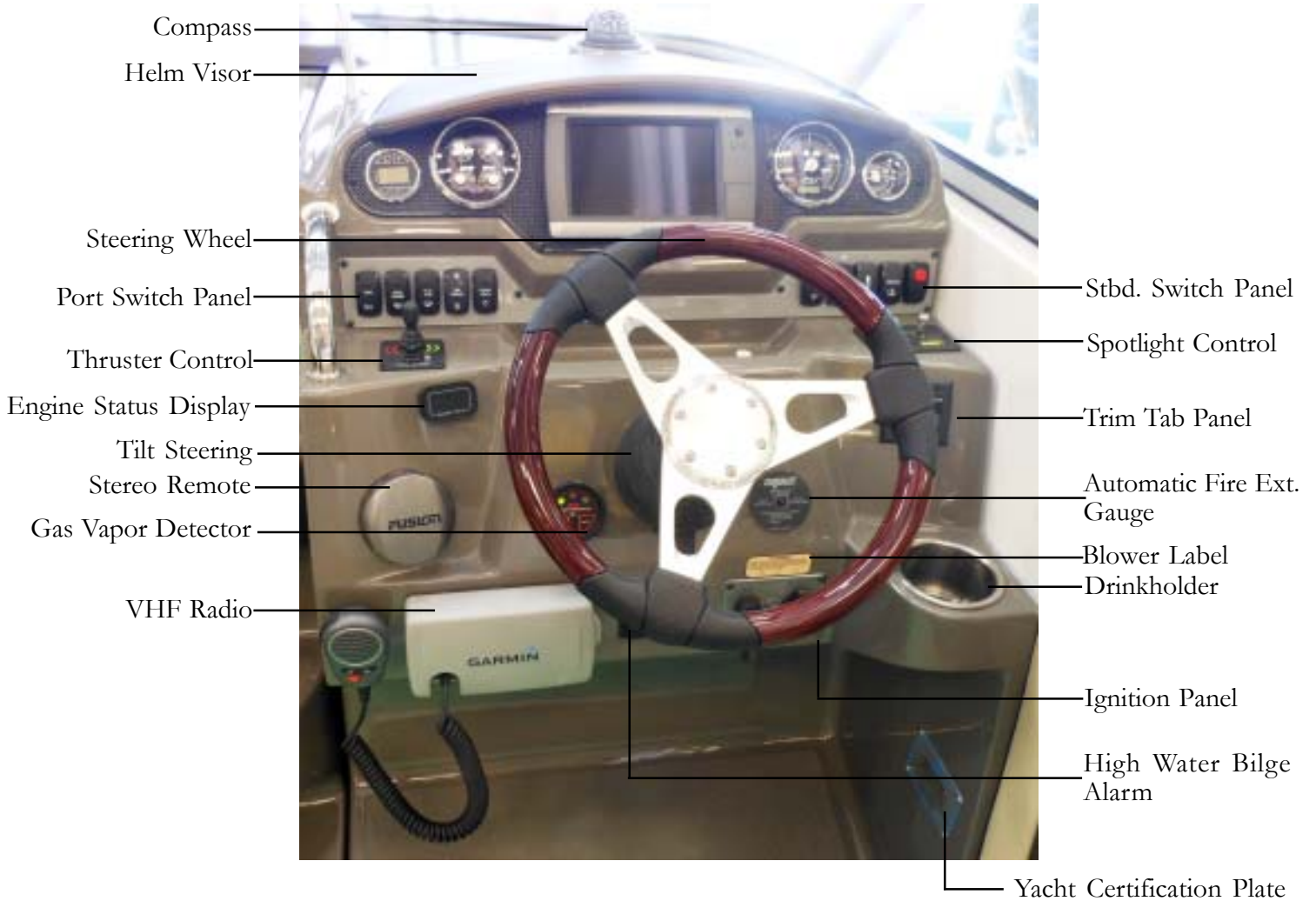

Note: The typical helm information may include optional equipment and may not show all available equipment on your vessel.



REMOTE CONTROL

Your vessel uses a single lever remote control. Avoid shifting into reverse while the boat is making fast forward headway. Be prepared to “bump” the reverse throttle to completely stop the vessel from a forward headway position. The handle controls both throttle and gear shift operations.

Push the lever forward and the engine will shift into forward gear. The engine rpm’s will increase as the single lever control is pushed further forward. **Pull** the single lever back from the neutral position toward the stern of the boat and the engine will shift initially into reverse and the engine rpm’s will increase as the handle is pushed further into reverse.

The lever must be in the neutral detented position for the engine to start. The remote control uses a neutral safety switch (located inside the remote control box) which permits starting in the neutral position only. The throttle only button (neutral position) when pushed in allows you to advance the throttle without engaging the gear shift. This feature is useful when trying to start a cold engine. **Do not shift the remote control handle in or out of gear without the engine running as drive/shift malfunctions could occur.**

Notice that the remote control has designated *power* trim functions controlled by switches normally mounted on the remote control box along with a dash gauge(s) that allows you to change and monitor trim angle. *Do not confuse this with the trim tabs that may be mounted in the outer port and starboard transom.*

On selected models a transom mounted tilt switch raises the outdrive beyond the trim elevation. This feature is especially useful when inspecting or changing the outdrive propellers or at the launching ramp. Operate the tilt function only when the boat is stopped in the water or the engine could overheat from a lack of water being picked up by the outdrive.

When using a control with the single trim/trailer switch the operator needs to keep a closer eye on the trim gauge so the drive unit is not angled up excessively. As the operator gains more experience he will know the best trim angle for his vessel as indicated on the trim gauge. See the illustration for a brief description of the remote control. Refer to the engine manufacturer’s owners manual for more complete remote control operation instructions.



WARNING

TO PREVENT BODILY INJURY
AND PROPERTY DAMAGE
DO NOT ATTEMPT TO ADJUST
THE REMOTE CONTROL.
CONSULT A MARINE PROFESSIONAL.

NOTICE

TO PREVENT POSSIBLE CONTROL/STERN
DRIVE DAMAGE DO NOT SHIFT REMOTE
CONTROL IN OR OUT OF GEAR WITHOUT
THE ENGINE RUNNING.

Engine & Controls

TYPICAL REMOTE CONTROL

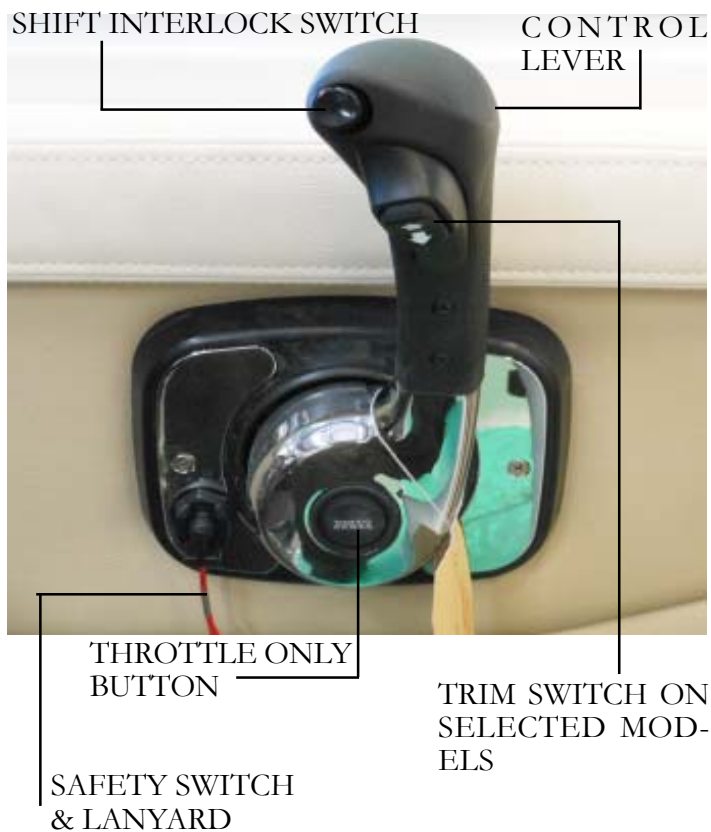

Note: Volvo Remote Control Shown In Neutral Position.

NOTICE

TO PREVENT POSSIBLE CONTROL AND/OR STERN DRIVE DAMAGE THE REMOTE CONTROL /CABLE SYSTEM MUST BE LUBRICATED PERIODICALLY. CONTACT YOUR CLOSEST AUTHORIZED REGAL DEALER.

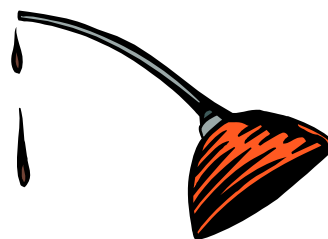

NOTICE

THE SAFETY SWITCH MUST BE IN THE "ON" POSITION OR THE ENGINE WILL CRANK OVER BUT NOT START AS THE IGNITION KEY IS TURNED TO THE START POSITION. ALWAYS HOOK THE LANYARD TO A PIECE OF CLOTHING SUCH AS A BELT. WHEN HOOKED UP PROPERLY THE LANYARD WILL CAUSE THE ENGINE TO STOP SHOULD THE OPERATOR BE DISPLAYED FROM THE HELM SEAT POSITION.



Notes

Systems

ELECTRICAL OVERVIEW

Your vessel uses direct current (D.C.) and alternating current (A.C.). You need to understand the basics of each type of electrical power used on board. Besides the general information in this manual refer to the various equipment manufacturer's literature located in the owner's information packet. Also, contact your closest Regal dealer or marine professional as required for troubleshooting information.

Your vessel may not contain all of the equipment or systems shown. ***Regal has the right to change, update or add equipment and systems at anytime as our on-going committment to upgrading our product line.***

 **WARNING**

**PREVENT SEVERE INJURY OR DEATH!
USE ONLY APPROVED MARINE
REPLACEMENT PARTS
THAT ARE IGNITION PROTECTED.**

 **WARNING**

**PREVENT SEVERE INJURY OR DEATH!
BE SURE TO DISCONNECT
ALL ELECTRICAL POWER SOURCES
BEFORE ATTEMPTING TO REPAIR OR
REPLACE ELECTRICAL COMPONENTS.**

DIRECT CURRENT (D.C.)

Your vessel utilizes 12 volt D.C. electricity otherwise known as direct current. It is called D.C. because it flows only one way in a circuit. Specific wiring harnesses, gauges, batteries, battery cables, engine electrical components, dash switches, lighting, fresh water, shower sump and bilge pumps, refrigerators, toilets, along with any overcurrent protection are all part of the low voltage system. In this system, the black wire is designated as the "hot" or conductor wire and the white wire is referred to as the ground wire. All other current carrying wires are color coded to identify their circuit. This is especially helpful in troubleshooting and adding additional equipment. Be sure to review the wiring schematics in the technical drawing section.

Direct current is *produced* through the engine alternator while the boat engine is running. The alternator charges the batteries and sends current through the main distribution panel and battery switch via the required harnesses to the appropriate battery. Normal voltage on the dash volt meter is between 12 and 15 volts. Lower or higher readings could indicate a charging malfunction or weak battery.

The alternator is normally internally "excited" around 1200 revolutions per minute and will show normal readings up to 15 volts as the engine speeds above the idle range. At idle speeds below 1200, the volt meter will show around 12 volts. With the key in the "on" position and a fully charged battery the volt meter should read around 9 volts. Voltages below this indicate a possible electrical problem.



BATTERIES

Direct current is *stored* in the ship's wet cell batteries. There are 2 engine starting batteries. The battery circuit uses an on/off type battery switch that provides a positive battery disconnect, isolates all circuits and aids in protection against electrical fire, explosion and adds an extra security factor.

The dockside shorepower system via a battery charger takes the place of the engines alternator to produce direct current.

The shore power cord sends house current through the battery charger and it is converted to direct current at the battery charger. In this scenario the main D.C. distribution panel converter switch/breaker needs to be activated for the current to flow to the ship's batteries. When replacing batteries make sure the correct size and capacity are used. Always replace batteries in sets. Your Regal dealer will be able to assist you in obtaining the correct battery replacement. The factory recommends 650 cold cranking wet cell ampre batteries.



Typical Twin Battery Installation

Marine batteries are described and rated by the following terminology:

A. Battery cold cranking performance rating- The discharged amperes(pressure in a circuit) that a battery at 0 degrees Fahrenheit can transfer in 30 seconds and still maintain 1.2 volts per cell or higher.

B. Cranking performance- The discharge in ampres that a new completely charged battery at 32 degrees Fahrenheit can continually deliver for 30 seconds, and maintain a voltage at the terminals of 1.2 volts or higher.

C. Battery reserve capacity- A number in minutes that a completely charged battery at 80 degrees Fahrenheit can be continuously discharged at 25 ampres and hold a voltage of 1.75 volts or higher per cell (10.5 volts for 12 volt marine battery).

Since your vessel's battery system is one of the most important on board systems, refer to the maintenance section for proper battery servicing and storage procedures. All battery terminals should contain a thin layer of anti-corrosion grease encapsulating the entire terminal surface. Battery electrolyte must be filled to the proper level to ensure a longer battery life. All fastening hardware must be kept tight to hold the batteries in place. Battery boots (red) must cover the entire positive terminal to prevent any possible arcing from tools, etc.

BATTERY CHARGER

The battery charger is located in the engine room. Its function is to keep the batteries fully charged, to provide engine starting power and house D.C. circuit energy. The battery charger operates on 120 volt A.C. shore power to provide the A.C. source for the battery charger to function.

At the ship's main A.C. panel the battery charger breaker needs to be energized for the batteries to be charged from dockside. The battery charger utilizes an amp meter on its face which displays the charger output. The battery charger is a self-limiting device which means the charger output remains at a value that will not damage the charger if a short circuit develops at the D.C. output terminals over a specified period of time.



NOTICE

AS A SAFETY FEATURE
THE BILGE PUMP, STEREO MEMORY
AND CO CIRCUITS
ARE CONTINUOUSLY "ALIVE" OR "HOT"
EVEN WITH THE BATTERY SWITCH
IN THE "OFF" POSITION.

The battery charger features a volt and amperage display on the face of the unit. It will tell you if the battery system numbers are within parameters.

The system is pre-set at the factory for battery type. Read and understand the vendor literature especially the operation section.



BATTERY MANAGEMENT CENTER



Your vessel features an on-off style battery switch. This battery switch controls both the house and engine starting batteries on your vessel. Remember that one battery serves a dual purpose for house uses and engine starting.

Never turn the battery switch to the “off” position with the engine running as it could cause engine alternator or charging system damage.

Upon leaving the vessel it is recommended that the battery switch be turned to the “off” position. For security purposes this will deactivate both engines and the related house circuit. but the automatic bilge pump, carbon monoxide detectors and the stereo memory circuits will operate as normal.

There may be times when you want to charge up both boat batteries while at dockside. To accomplish this, install the dockside cord at the boat first. Then plug the dockside cord into the marina 30 amp service fitting. Twist lock both ends into the inlets. Turn on the breaker if applicable at the dockside service side. Make sure the dockside cord is not dangling in the water but has enough slack if in a tidal area. Activate the breaker at the boat shore power inlet which is under the cockpit seat.

Activate the shore power 30 amp breaker on the ship’s main A.C./D.C. panel. Around 120 volts should display on the ship’s panel A.C. volt meter along with the green light on the ship’s panel.

At this point flip on the battery charger breaker to energize the battery charging process.

A couple noteworthy features of the battery management are as follows:

1. **Combine Batteries-** Turn the selector switch to the designation area marked on the switch. If one engine battery is weak and more cranking power is needed this feature will allow both batteries to be used to crank over the engine. After starting turn the selector switch back to the area marked “ON” *not to off*.

2. **The VSR (voltage sensitive relay)-** The main purpose for the VSR is to keep both batteries from being discharged. When one battery rises above 13.7 volts DC the VSR switches to charge both batteries in parallel simultaneously. When battery voltage drops below 12.8 volts DC the VSR disengages. When the icon is closed, the unit icon lights which at that point is sending current to the battery(ies).

CAUTION

**AVOID POSSIBLE FIRE
AND/OR EQUIPMENT DAMAGE.
DO NOT TURN THE BATTERY SWITCH
TO THE “OFF” POSITION
WITH THE ENGINE RUNNING.**

HELM SWITCH PANEL OPERATION



PORT PANEL

Below is a description of the port dash switches. Read and understand their operation. **Your dash may not include all of the switches.**

Horn

The horn is controlled by a toggle switch which is used for audible signaling. Read and understand the horn signals explained in the Rules of the Road chapter.

Blower

The blower switch controls the bilge blower. The blower must be activated to the “on” position at least 4 minutes prior to starting the engine. This procedure assists in evacuating any fumes in the bilge area. The blower should be used below cruising speeds. Besides activating the blower switch a visual check should be done before starting the engine by lifting the engine inspection hatch and “sniffing” for fumes in the bilge. A red icon located in the center of the switch lights up when the blower is activated.

Bilge Pump

This switch controls the bilge pump. When the switch is depressed it bypasses the automatic float and activates the bilge pump. In the off position the automatic float feature monitors the pump. When the icon located in the middle of the switch is lighted red the automatic system is activated and further investigation is required.

Nav/Anchor

The red and green navigation lights along with the masthead anchor light are controlled by this switch. Read and understand all the rules regarding use of navigation lights for night running.

Cockpit Light

The cockpit lights are useful for safely accessing areas of the boat after dark. These lights are normally positioned at points such as entrances and stairways.

 **WARNING**

**GASOLINE VAPORS CAN EXPLODE!
BEFORE STARTING ENGINES
RUN BLOWERS FOR AT LEAST 4 MINUTES
AND CHECK ENGINE COMPARTMENT
FOR GASOLINE LEAKS OR VAPORS.
RUN BLOWER(S) BELOW CRUSING SPEEDS.**



STBD. PANEL

Permit

This two-way toggle switch features a red “lockout” button in the “OFF” position which prevents accidentally letting the anchor out even though the windlass switch is activated. The foot deck foot pedal is inoperative with this feature activated.

Below is a description of the starboard dash switches. Read and understand their operation. ***Your dash may not include all of the switches.***

Wiper

This switch controls the windshield wiper operation.

Underwater Lights

This switch controls the underwater lights which are mounted on the lower boat transom under the waterline.

Arch

This toggle switch controls the hydraulic system that lays the power tower in a forward position.

Windlass

This rocker style switch is used to adjust the anchor line after the anchor has been set. The bow pedals are used to commission the anchor as well as retrieving it. *Do not use this switch to break the anchor from the bottom.*

IGNITION SWITCH PANEL



20 AMP IGNITION BREAKER

12 VOLT ACCESSORY PLUG

WARNING

**AVOID BODILY INJURY OR DEATH!
REMOVE KEY FROM IGNITION
SWITCH WHEN THE ENGINE
IS NOT RUNNING.**

Ignition Switch

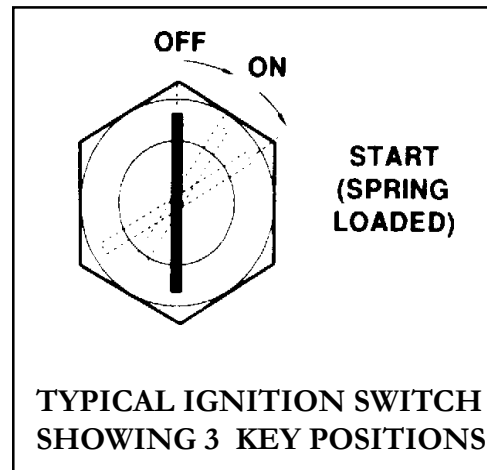

**TYPICAL IGNITION SWITCH
SHOWING 3 KEY POSITIONS**

The ignition switch features three positions; off, run, and start. The start position is spring loaded and the key should be held in this position to engage the starter. Once the engine has started release

the key from the start position. It will then be energized in the run position. The key switch features overcurrent breakers. Remove the key from the ignition switch when the engine is not running.

DC CIRCUIT PROTECTION

A source of engine circuit protection is located on the engine itself. On Volvo engines, there is a flat plug on the engine that interfaces with the boat harness to the dash. Within this system there are selected in-line fuses that protect the key switch as well as the dash gauges. It does not power the dash switches such as bilge pump, blower, etc. If an engine circuit fuse “blows” determine the cause of the malfunction before replacing the fuse. Consult the engine manufacturer’s manual located in the owner’s information pouch for further information.



TYPICAL MISC. GAUGES & CONTROLS

Below is a description of various gauges and controls. Refer to your vendor product information for further literature. **Your dash may not include all of the equipment outlined below.**

Spotlight

The spotlight control features two functions. The left-sided switch center position is off. Other switch positions will deliver either flood or spot type lights. The right-side button controls the directional pathway of the light. This is useful for docking or spotting objects in the water. The switch is lighted at night.

12 Volt Accessory Plug

The 12 volt (D.C.) accessory receptacle accepts items which feature male connectors similar to the ones you plug into your automobile cigar lighter. It is useful in charging up cell phones and low amperage equipment. Disconnect any equipment from the plug when not in use and attach the protection cap on the receptacle.

High Water Alarm



To test the unit press the dash switch. Read vendor information in the document pouch.

The high water alarm consists of a float switch in the bilge and an audible helm alarm. Should an alarm sound stop the engine and check the bilge for incoming water. To test the unit press the dash

Stereo Remote

The stereo remote may be dash mounted but more often is found in the aft cockpit. It features controls that permit operation of many stereo functions away from the main unit such as volume, stations, and selected modes of operation ie; CD player.

Gas Vapor Detector

The gas vapor detector determines if there is a level of gasoline vapors that is unsafe in the engine room of the bilge. If installed, turn on the unit and wait about one minute for the unit to do a safety test. If all is well it will display a green light. You must run the test before you start the engine. In the event you do not see a green light, you must investigate the bilge of the vessel for gas fumes or signs of a fuel system leak. If uncertain how to proceed, call a marine professional.

Automatic Fire Extinguisher

The automatic fire extinguishing system utilizes an instrument display unit (gauge) that provides the operator with a system status of a charged or uncharged condition by an audible alarm. With the ignition turned on the indicator light shows system is charged and operating properly. With the ignition on and a no light condition; this shows the system has discharged.

If the system should discharge the ignition system will be instantaneously interrupted. Should this occur shut down the engine, ventilation blower, and any electrical system components. Investigate the source of the shutdown immediately and take appropriate action.

Also, in the cockpit is located a manual release for the automatic fire extinguishing system. Find the release and read the related instructions in this manual and the vendor's information regarding the operation of the manual release mechanism. In case of emergency inform other crew members on the operation of the fire extinguishing system.

COCKPIT BREAKER PANEL



The cockpit breaker panel is accessed by lifting the cushion behind the helm seat. The breakers are resettable and the glass fuses can be replaced. When a breaker “pops” or a fuse “blows” always determine the cause of the problem before attempting to reset or replace the device. All of the components listed may not be installed on your vessel. NOTE: Panel breaker sizes are listed by amperage.

12 RECEPT

This breaker protects the 12 volt signal horn.

EXH BLOWER

This breaker protects the 12 volt bilge blower used to evacuate any gas fumes.

BILGE PUMP

This breaker protects the standard aft bilge pump located at the front of the engine.

NAV LTS

This breaker protects the navigation light circuit including the red and green deck lights along with the all round or stern light.

COCKPIT LTS

This breaker protects the blue LED cockpit light system.

UNDERWATER LTS

This breaker protects the LED underwater light system.



WIPER

This breaker protects the starboard side windshield wiper.

WINDLASS

This breaker protects the anchor windlass system.

NEUTRA SALT

This breaker protects this Volvo only system.

TRIM

This breaker controls the 12 volt trim tab system attached to the outer transom.

BILGE LTS

This breaker protects the 12 volt work type lights located in the bilge.

GAS VAPOR

This breaker protects the gas vapor detector. The system gauge is dash mounted and the sensor is located in the bilge.

ARCH LT

This breaker protects the hydraulic system which allows the arch (power tower) to lay forward.

12 RECEPT

This breaker protects the 12 volt plug in dash receptacle

SPOT LIGHT

This breaker protects the optional 12 volt spotlight circuit.

HIGH WTR ALM

This breaker protects the high water alarm system located in the bilge along with the dash audible alarm.

COCKPIT FRIGE

This breaker protects the 12 volt cockpit refrigerator.

HATCH LIFT

This breaker protects the engine hatch hydraulic circuitry.

GPS

This 3 amp glass type fuse protects the dash mounted GPS circuitry.

VHF

This 10 amp glass type fuse protects the ship to shore radio circuitry.

PLOTTER

This 7.5 amp glass type fuse protects the chartplotter circuitry.

HALON

This 2 amp glass type fuse protects the automatic fire extinguishing system.

ACC 1

This 10 amp glass type fuse permits the addition of 12 volt equipment. Make sure the fuse is matched to safely protect the equipment.

ACC 1

This 15 amp glass type fuse permits the addition of 12 volt equipment. Make sure the fuse is matched to safely protect the equipment.

MAIN D.C. PANEL (TYPICAL) SWITCH FUNCTIONS

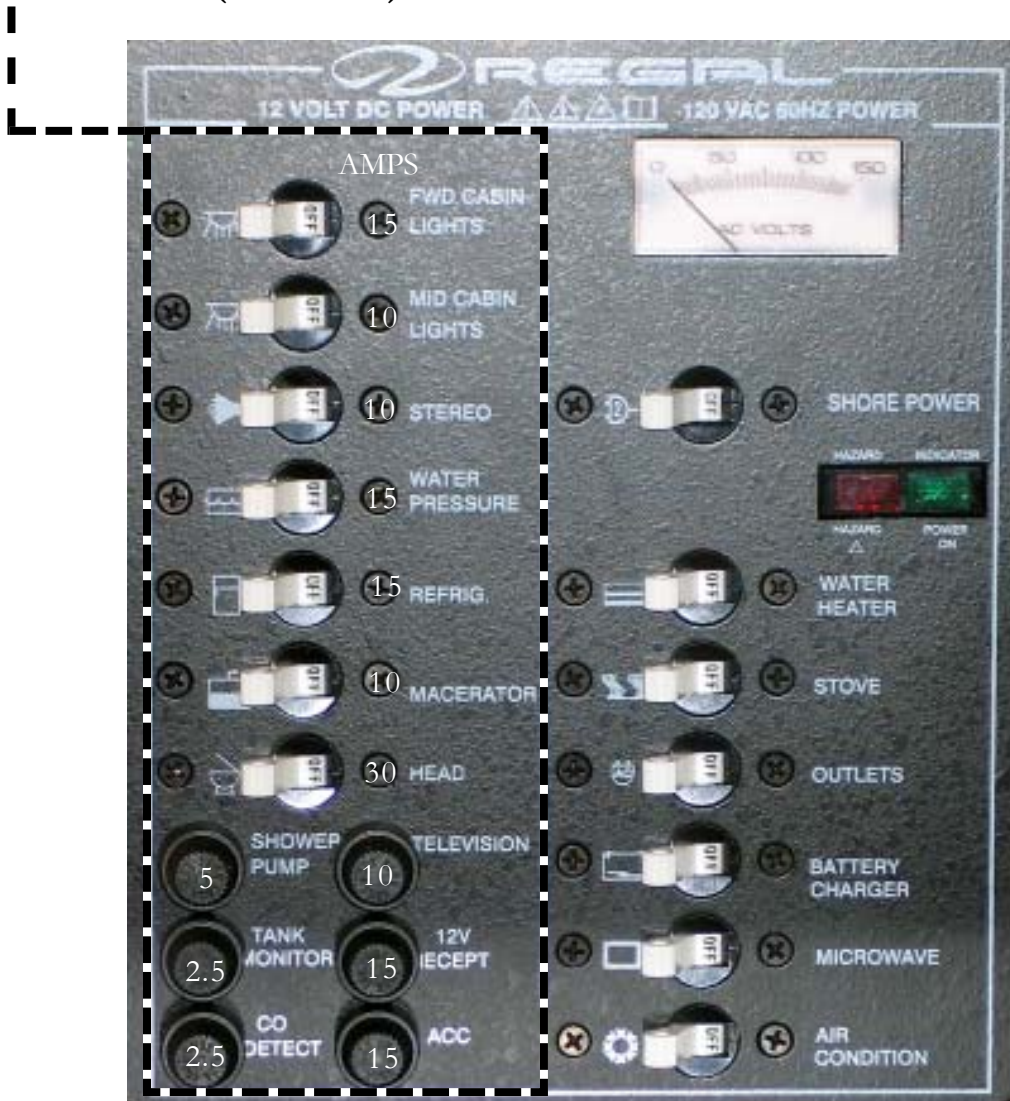

D.C. Line Voltage

The D.C. line voltage indicates current battery voltage. Normal readings should be above 12 volts although it is not abnormal for the meter to fluctuate somewhat. As D.C. equipment is activated the volt meter will indicate a slight change in meter readings. With the battery switches in the off position upon leaving the vessel the meter will not indicate any voltage. This is normal.

D.C. Switches

The D.C. switches control various equipment functions on the vessel. By activating each switch you will be able to determine its corresponding shore power breaker. Upon leaving the vessel turn all switches and breakers to the "off" position. If a breaker "pops" due to an overload it will assume a "middle of the road" position until the thermocouple cools down and it can be reset. Always determine the cause of an overload and repair the problem before trying to reset the breaker.



D.C. PANEL SWITCH FUNCTIONS

Fwd. Cabin Lights

This switch controls the lights in the forward cabin. Once energized the individual cabin lights can be operated.

Mid Cabin Lights

This switch controls mid or aft cabin lights.

Stereo

This switch controls the 12 volt stereo.

Water Pressure

This switch controls the flow to the boat's fresh water system through the fresh water tank. The system provides water to the galley, head, and cockpit faucets. Before energizing the switch be sure the fresh water tank on the monitor panel shows a safe level. Running the fresh water pump without sufficient water may cause water pump and/or system damage.

Refrigerator

The **main cabin** refrigerator is controlled by this switch. The refrigerator features 12 volt D.C. current. Remember the refrigerator demands substantial amounts of D.C. current. The battery connected to the refrigerator will discharge steadily without it being charged through the engine alternator or battery charger. Be sure the battery charger switch is activated on the main A.C. panel while connected to shore power to keep food at a safe temperature.

Macerator

This switch controls the optional overboard discharge pump also known as the macerator. With this switch on along with the key being turned to the on position at the monitor panel the waste tank can be pumped overboard or through a marina pump-out station. If pumping overboard make sure you are outside the legal limit. Read and understand all the laws in reference to pumping out waste including local restrictions.

Finally, once you determine it is legal to pump waste overboard position the seacock to the open position before starting the macerator.

NOTICE

TO AVOID MACERATOR DAMAGE
SEACOCK MUST BE IN THE OPEN POSITION
FOR PUMPING OVERBOARD.

Head

This switch energizes power for the electric toilet.

Television

This 10 glass type fuse controls the 12 volt flat screen cabin television.

12 Volt Receptacle

This 15 amp glass type fuse controls the cabin 12 volt receptacle plug.

Acc

This 15 amp glass type fuse allows operation of any accessories that are connected in the circuit. Make sure the equipment does not exceed recommended circuit overcurrent protection.

Shower Pump

The shower pump 5 amp fuse protects the sump pump located under the main cabin floor. Look for loose connections or debris caught in the pump grate if the fuse “blows”. Replace the fuse with the correct amperage and type.

Tank Monitor

This 2.5 amp fuse controls the fresh and waste water tank monitor gauge. In the “on” position the level monitor panel can be activated to determine their respective system levels.

CO Detect

This 2.5 amp fuse located at the D.C. distribution panel protects the 12 volt CO detectors in the aft and forward cabins. Should there be an overload on the circuit the fuse will “blow”. Determine the cause of any overload before replacing the CO fuse. When the fuse blows you probably will hear the CO detectors audible alarm warning indicating protection is no longer available and the detector is running off battery backup battery cells located in the CO detector itself.



ALTERNATING CURRENT (A.C.)

GENERAL INFORMATION

Alternating current is sometimes referred to as A.C. It is brought to the vessel through the use of a shore power (dockside) cord. Marine alternating voltage normally is measured domestically at 120/240 volts. It is important to familiarize yourself and understand the various parts of the main A.C. panel. It is of prime importance to respect alternating current on board your vessel just as you do your home electricity.

 **CAUTION**

PREVENT POSSIBLE ELECTRICAL SHOCK!
SHOREPOWER CORD OUTLET MUST BE COMPLETELY DRY BEFORE ATTEMPTING TO PLUG INTO THE DOCKSIDE POWER INLET.

 **CAUTION**

PREVENT POSSIBLE ELECTRICAL SHOCK!
SHOREPOWER CORD MUST NOT LAY IN THE WATER. STRESS RELIEF IS ESSENTIAL TO PREVENT INTERNAL DAMAGE TO CORD PLUG AND OUTLET.

 **DANGER**

PREVENT BODILY INJURY, DEATH OR FIRE!
NEVER USE EXTENSION CORDS OR IMPROVISED CORDS IN THE SHORE POWER INLETS.
USE ONLY APPROVED MARINE SHORE POWER CORDS.

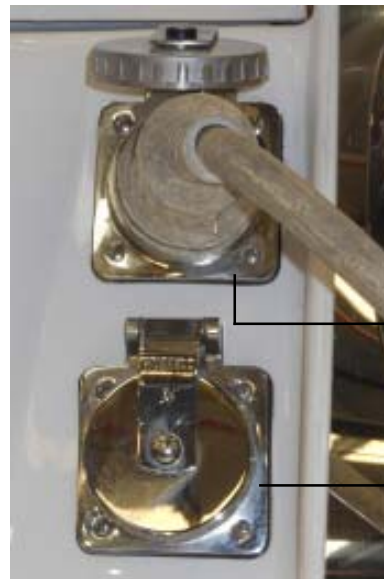

TV CABLE

SHORE POWER INLET

TELEVISION CABLE INLET

SHORE POWER INLET

The shore power inlet is found at the aft starboard transom.

When connecting the shore power cord to the inlet notice the three contacts are all different shapes. Align the contacts with the inlet & insert the cord into the socket. Then twist the plug. Next, screw the threaded cord fitting into the inlet plug threads to lock and seal the fitting.

Plug the power cord into the dockside receptacle last. This reduces the possibility of a shock hazard.

When disconnecting the shore power cord remove the plug from the dockside outlet first. Then remove the plug from the ship's power inlet.

Note that some dockside power boxes will not accept the male twist shore power cord. Some older power boxes use a 3 prong system similar to a house receptacle. You may need to buy an adapter that changes from a twist connector plug to 3 prong connector plug. They can be purchased at most marina supply houses. Make sure it is the same capacity as the shore power cord.

ELCI

One of the main components found after the shore power inlet in the A.C. electrical system is the ELCI breaker.

ELCI stands for equipment leakage circuit interrupter. Technically it is a residual current device which detects equipment ground fault leakage current and disconnects in 120VAC 60Hz systems the hot (ungrounded/black) and the neutral (grounded/white) current carrying conductors at a preset threshold.

The trip level is a maximum of 30 mA and the trip time is a maximum of 100mS. As a comparison a GFCI (ground fault circuit interrupter) has a maximum trip level of 5 mA.

Once the 30 amp ELCI breaker is energized the hot and neutral wires travel to the main ship's panel for distribution to components while the green ground wire travels to the galvanic isolator.

One of the features of the ELCI panel is a "leakage fault" detector located to the left of the 30 amp breaker. The leakage hazard helps prevent a possible fire and/or human injury due to shock. The leakage fault feature detects a change in the current carrying neutral wire current. Should the current change more than 30 mA or about 1/3 of an amp the unit senses the difference and will "trip" the breaker causing the leakage fault LED to illuminate red. This condition clearly indicates that the trip occurred as a result of leakage. Before resetting the ELCI breaker determine the cause of the leakage fault. A fault is basically a circuit where unintentional grounding has occurred. It is commonly referred to as a short circuit.

A proper operating A.C. system will display a green illuminated LED at the "power" marked area of the ELCI. Periodically test the ELCI circuit by depressing the "test" button. The breaker should "trip" indicating the system is functioning properly. After testing reset the breaker.

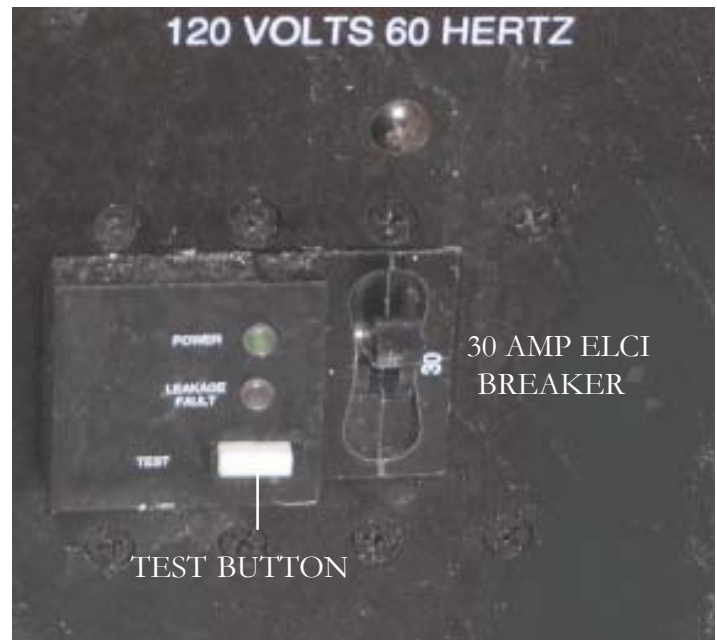

Note: The ELCI system can undergo "nuisance tripping" which can cause the breaker itself to trip. This can be caused by overloads in the electrical draw. One way to minimize the situation should it occur is to monitor closer the energized devices on the yacht which will assist in keeping the total used amperage to a minimum.



TYPICAL GALVANIC ISOLATOR



A galvanic isolator located in the sump is connected in series with the A.C. grounding “green” wire. The purpose of galvanic isolator is to isolate the yacht’s grounding system from the shorepower ground. The galvanic isolator permits A.C. voltage to travel back to the green

ground wire at the marina dockside center in the event a short exists in the boat.

Also, the isolator blocks any D.C. current from traveling on the green “ground” wire. This assists in eliminating the possibility of galvanic interaction from other boats in the vicinity.

The green ground or “bonding” wire runs from the yacht’s shore power inlet to the galvanic isolator. From the output of the galvanic isolator it runs to the A.C. ground buss located in the ship’s main A.C. panel.

Since the galvanic isolator is not polarized either terminal can be used for the inlet or outlet side for the green grounding wire.

There is a fan located inside the galvanic isolator. If you hear the fan running the isolator has failed. Disconnect the shore power from the vessel and check the system. Call your closest Regal yacht dealer for more information.

MAIN A.C. PANEL (TYPICAL) SWITCH FUNCTIONS

REVERSE POLARITY INDICATOR
A.C. LINE VOLTAGE

SHORE POWER
MAIN BREAKER

Note: Vessels with generators use a remote panel with a second A.C. main breaker as part of a generator transfer cycle.



A.C. Line Voltage

This meter displays the alternating line voltage as read by the A.C. panel. Normal voltage should be around 120 volts. Sometimes the voltage reads lower because of spikes in the current or unusually long wire runs at marinas that cause voltage drops.

A.C. Switches

The A.C. switches/breakers activate and protect equipment functions on the vessel. Upon leaving the vessel turn all switches and breakers to the off position. If a breaker “pops” due to an overload it will assume a “middle of the road” position until the thermocouple inside the breaker cools down to the point that it can be reset. Always determine the cause of an overload and repair the problem before trying to reset the breaker.



Reverse Polarity

The reverse polarity indicator icon on the main panel uses green and red lights. With the shore power cord in place and the shore power main breaker in the “off” position the light will indicate green or red. As with a traffic light green is go and on board the vessel it means the power is connected properly. At this point the main shore power breaker can be activated.

If the reverse polarity indicator on the shorepower panel shows red the hot conductor wire is reversed at some point. Do not attempt to energize the shore power main breaker at this point. Disconnect the shore power cord from the dockside receptacle. There may be a problem with the dockside wiring. Contact the appropriate personnel.

NOTICE

TO PREVENT POSSIBLE ELECTRICAL SYSTEM DAMAGE OR FIRE DO NOT TRY TO ACTIVATE THE SHORE POWER BREAKERS IF THE REVERSE POLARITY LIGHT IS DISPLAYED.

Water Heater

This switch controls the A.C. current to the water heater located in the sump (bilge). Notice the warning on the panel that says the water heater must not be activated without the unit being filled with water. Once the fresh water switch is activated water will flow to the heater through the piping via the fresh water tank which can be monitored on the water/waste display panel.

Stove

This switch controls power to the galley electric stove.

Outlets

This switch controls the A.C. outlets in the salon, head forward and aft cabins. These outlets are all GFCI protected.

Battery Charger

This switch controls alternating current to the battery charger located in the bilge. When leaving the vessel the battery charger breaker should be activated to keep the batteries charged.

Microwave

This switch controls the galley microwave.

Air Conditioner

This switch controls the air conditioner located in the main cabin. This breaker allows power to the A/C monitor panel located in the salon.

GENERATOR OPTION



If installed the generator provides A.C. voltage while at sea.

Before Activating Generator

Before attempting to start the generator make sure all equipment switches and shore power breakers on the main ship's panel along with the generator sub panel are in the "off" position. This procedure assists in eliminating any voltage equipment surges upon generator start-up. Ensure that the generator switch is off on the sub panel.

Make sure the generator seacock is in the "open" position. It is located in the sump. Also, make sure the generator fuel valve is in the "open" position.

Generator Start-Up

At this point start the blower switch and allow to run for at least 4 minutes before starting the generator. Press the momentary start switch and release. The generator will start. While the generator warms up check immediately for water at the generator exhaust.

Shut down the generator switch immediately if no water is exiting the generator exhaust.

Generator Transfer

The generator is now ready to transfer A.C. current to the applicable equipment components.

Position the generator switch to the "on" mode and at the same time push the transfer bar to the right. This will result in the generator switch set to a full "on" position. At this point, turn the A.C ship's main panel shore power breaker to the "on" position. Equipment breakers can now be activated as needed.

Note: Never flip the main ship's panel shore power breaker to the "off" position with equipment breakers still being activated as it could cause generator/component circuit damage.

Generator Shutdown

To shut the generator down deactivate any equipment breakers on the main panel. Deactivate the main ship's panel shore power breaker. Move the transfer bar to the left which will force the generator breaker to the "off" position. Touch the generator stop toggle switch and release. The generator will stop.



GFCI Outlet

Sometimes current in a circuit escapes its normal route and finds a “ground fault”. If that vehicle ends up to be your body and the current passes through your heart the results could be deadly.

A ground fault circuit interrupter (GFCI) senses this ground current before a fatal dose can be conducted and in a fraction of a second cuts the current.

The GFCI device marine speaking is not ignition protected which means the device can not be installed in the engine room or the fuel tank area of a gasoline powered boat because of increased explosion possibilities. Your vessel has several 120 volt receptacles. A GFCI style outlet is found as the first receptacle in the circuit. By this placement all 120 volt outlets downline are protected.

You can identify the GFCI primary receptacle by the test and reset breaker in the center of the device. Check for GFCI protection monthly. If a problem develops with the GFCI circuitry call a marine electrician to access the situation.

GFCI outlets are especially useful when electrical equipment is used such as drills, curling irons and hair dryers. Never use any electrical devices when puddling water is present to prevent possible shock hazard.

Testing GFCI'S



To test a GFCI on your yacht find a 120 volt night light or small lamp to plug into the GFCI outlet. Try the device in another circuit first to make sure the device lights.

After the lamp is plugged into the GFCI outlet the lamp should light.

Now press the “test” button at the

CFCI receptacle center. The GFCI “reset” button should pop out and the lamp or night light should go out. This means the GFCI device is functioning properly. You can use the lamp or night light to check each of the outlets downstream from the GFCI receptacle. The lamp should go out each time it is moved to a different outlet on the same circuit as the GFCI “test button” is pressed.

Also, GFCI down stream receptacles can be tested with a plug-in type GFCI tester. This tester contains its own GFCI test button which accomplishes the same end as the GFCI receptacle “test” circuit. These testers can be purchased at “box” stores, electronic outlets or marine supply stores.



TYPOCAL GFCI OUTLET

Ignition Protected Devices

Many electrical devices in everyday use tend to “arc” or spark when being used. These include motors, fans, switches, relays, etc.

Vessels employ many of these same devices but they are shielded from any sparking that may cause the device to ignite with any vapors such as found in the engine and/or fuel tank areas. Shielded devices are known as being ignition protected.

When replacing any electrical device in the engine compartment make sure it is ignition protected. This means it has been tested and normally the device is stamped with a marking making it safe to use. Do not install any electrical device before ensuring it is ignition protected.

Many automotive stores sell replacement engine electrical parts such as alternators and starters. They do not feature flame arrestors and therefore must not be used in the engine compartment. Use only the engine manufacturer’s approved replacement parts in the engine compartment.



FUEL SYSTEM OVERVIEW

The fuel system consists of a fuel tank, fittings, hoses, filters, anti-siphon valves, gauges and distribution systems. The fuel system has been inspected at several points during your vessel's construction.

Regal has the right to change, update or add equipment and systems at anytime.

 **WARNING**

PREVENT POSSIBLE INJURY OR DEATH!
DO NOT USE ANY ALCOHOL ENHANCED
FUEL OTHER THAN GASOLINE.
THIS CAN LEAD TO DETERIORATION OF THE
FUEL SYSTEM COMPONENTS AND CAN
CREATE AN EXTREMELY HAZARDOUS
CONDITION RESULTING IN POSSIBLE
FIRE OR EXPLOSION.

FUEL SYSTEM COMPONENTS

FUEL TANK

Your vessel features an aluminum or injection molded fuel tank. It is manufactured to rigorous standards. The fuel system fittings and hoses need to be periodically checked (at least twice per year) through access plates located in the cockpit or bilge area.

FUEL FILL

The fuel fill is located on the aft deck area. It is labeled for gas. Select boats use a "key" to open and close the fill caps. It fits in the slot or the 2 holes in the fuel cap. Make sure the cap is tightly secured. If available, the key should be located in the owner's document pouch.

FUEL VENT

The gasoline fuel system produces vapors. These vapors are vented overboard. On the hullside you will find a vent fitting that displaces these vapors. As the fuel tank is being filled the vent will displace any fuel tank fumes. As the tank nears full you will hear a distinct sound of the gas vapors being displaced. *Be careful to slow the pumping rate near the full mark so gas does not exit the boat through the vent and into the water.* Periodically check the vent for a build up of spider webs, debris, etc. which can affect engine performance.

ANTI-SIPHON VALVE

The gasoline fuel system contains a device called an anti-siphon valve. It prevents fuel from siphoning out of the fuel tank in the event of a fuel hose rupture or leak. Never remove this valve from the fuel system. Should it become inoperative replace it. It is located at the fuel tank end of the fuel feed hose. Contact a marine professional for undertaking this job.

FUEL TANK GAUGE SENDER

The dash fuel gauge is an indication of the fuel tank level as determined by the sending unit. This calibrated instrument is not 100% accurate. Be sure to use the one third rule with regard to fuel reserves.

FUEL FILTER

Each engine regardless of brand uses a fuel filter. Some feature a spin on filter. The purpose of these filters is to trap foreign particles and water in the filter element. Because of the possibility of leaking fuel into the bilge these filters need to be replaced periodically by a marine professional. Call your closest Regal dealer for more information.

STEERING SYSTEM OVERVIEW

CAUTION

PREVENT POSSIBLE INJURY AND/OR
PROPERTY DAMAGE!
LOOSE OR MISSING FASTENERS
COULD CAUSE DAMAGE TO THE STEERING
SYSTEM WHICH COULD RESULT IN
LOSS OF STEERING CONTROL.
PERIODICALLY CHECK ENTIRE SYSTEM.

STERN DRIVE STEERING

Your stern drive (outdrive) vessel uses a rack or rotary style helm located steering system. This system transfers helm mechanical energy to the engine. There is a hydraulic steering cylinder as part of the engine along with a steering pump which sends fluid force to the stern drive steering arm changing the course of the boat, depending on the direction the steering wheel is turned.

Since the steering system is the primary link for engine control it must be periodically inspected and maintained.

The hardware at both the helm and engine locations must be checked regularly for tightness and/or leakage.

Refer to the steering manufacturer's literature in the owner's packet for more information along with the following illustration.

HELM MOUNTING BRACKET

SPENT TRAVEL TUBE

HELM

STEERING CABLE

**NOTE:
DO NOT REMOVE
TAG FROM PIN**

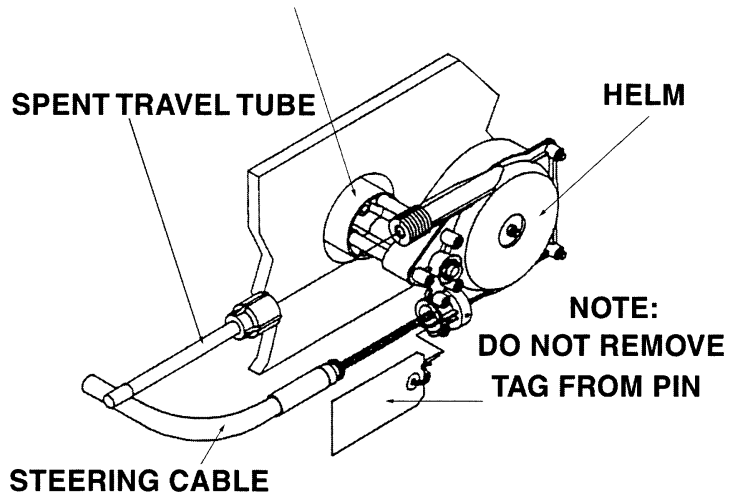

TYPICAL ROTARY SYSTEM SHOWN



TRIM SYSTEM OVERVIEW

Your stern drive vessel features both an outdrive controlled power trim and vessel transom mounted trim tab system. They use hydraulic cylinders which are driven electrically by a motor and valves which control the bow rise or port and starboard heeling angles depending on the particular system on your vessel.

Power Trim

The power trim system features a dash reference trim gauge. As the trim switch located on the remote control is activated the gauge will show a up or down resulting angle movement of the stern drive which effects bow rise.

TYPICAL POWER TRIM GAUGE



The power trim system features an electric D.C. motor, hydraulic pump, and reservoir. As the trim is activated fluid moves proportionally through the system. The pump reservoir system should be periodically checked for hydraulic fluid

levels. See the engine manufacturer's engine owner's manual for specifications and capacity of trim lubricant.

The power trim is normally used prior to accelerating onto a plane, after reaching the desired RPM or boat speed, and when there is a change in water or boating conditions. Position passengers and equipment in the boat so that the weight is balanced correctly fore and aft as well as side to side. Trimming will not compensate for an unbalanced load. To operate the trim, push the switch until the desired bow position is reached. The trim may be operated at any boat speed or at rest. Avoid operating the trim system when running in reverse. Observe the trim/tilt gauge which indicates the boat's bow position achieved by the trim angle of the vertical drive unit. "Bow-Up" corresponds to the upper portion of the trim range on the gauge while "Bow Down" corresponds to the lower portion of the trim range on the gauge.

To determine the proper trim angle, experiment a little until you are familiar with the changes in your boat. The vessel will be properly trimmed when the trim angle provides the best boat performance for the particular operating conditions. A trim position that provides balanced steering load is most desirable.

To familiarize yourself with the power trim, make test runs at slower speeds and at various trim positions to see the effect of trimming. Note the time it takes for the boat to plane. Watch the tachometer and speedometer readings as well as the ride action of the boat.

	WARNING
AVOID POSSIBLE INJURY OR PROPERTY DAMAGE! RETAIN CONSTANT VISIBILITY OF OTHER BOATS, OBSTACLES, AND SWIMMERS DURING BOW- RISE TRANSITIONAL PERIODS TO PLANING ALTITUDE.	

TRIM IN “BOW UP” POSITION



The “bow up” or out position is normally used for cruising, running with a choppy wave condition, or running at full speed. Excessive “bow up” trim will cause propeller ventilation resulting in propeller slippage. Use caution when operating

in rough water or crossing another boat’s wake. Excessive “bow up” trim may result in the boat’s bow rising rapidly, creating a hazardous condition.

TRIM IN “BOW DOWN” POSITION



The “bow down” or in position is normally used for acceleration onto a plane, operating at slow planning speeds, and running against a choppy wave condition. It is also used when pulling water skiers, tubers, kneeboarders, etc. In this position the boats bow will want to

go deeper into the water. If the boat is operated at high speed and/or against high waves, the bow of the boat will plow into the water.

TRIM IN “LEVEL” POSITION

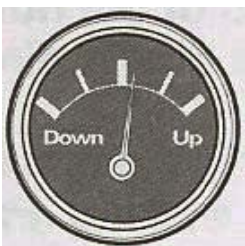

In normal running conditions, distribute passengers and gear so boat is level. At or below cruising speeds, trim the vessel for optimum performance. The trim gauge will show somewhere in the center of the gauge. This position will also enhance running visibility and

overall stability. Again, each outing provides different wave, load and running conditions. Be prepared to make trim changes as needed.



CAUTION

THE BOAT TRIM SHOULD BE ADJUSTED TO PROVIDE BALANCED STEERING AS SOON AS POSSIBLE EACH TIME YOU GET UNDERWAY. SOME BOAT, ENGINE AND PROPELLER COMBINATIONS MAY CREATE BOAT INSTABILITY AND/ OR HIGH STEERING TORQUE WHEN OPERATED AT OR NEAR THE LIMITS OF THE “BOW UP” OR “BOW DOWN” POSITIONS. BOAT STABILITY AND STEERING TORQUE CAN ALSO VARY DUE TO CHANGING WATER CONDITIONS. IF YOU EXPERIENCE BOAT INSTABILITY AND/OR HIGH STEERING TORQUE, CONTACT YOUR AUTHORIZED REGAL DEALER



CAUTION

DO NOT RUN ENGINE ABOVE 1000 RPM WITH THE STERN DRIVE TRIMMED FOR SHALLOW WATER MANUVERING SINCE THE STERN DRIVE IS OUT BEYOND THE GIMBAL RING SIDE SUPPORT BRACKETS. OPERATING IN ABOVE MANNER COULD PRODUCE A DANGEROUS STEERING CONDITION OR COULD DAMAGE STERN DRIVE COMPONENTS.



Trim Tabs

Trim tabs are installed on the hull lower transom area. Water is deflected and redirected as the trim tabs are raised and lowered from the dash switches. This change in water flow creates upper pressure under the tabs, and raises the stern. When the stern rises, the bow is lowered. Lowering the port tab will cause the port stern to rise, making the starboard bow lower. Lowering the starboard tab will cause the starboard stern to rise, making the port bow lower.

TRIM TAB DASH SWITCH

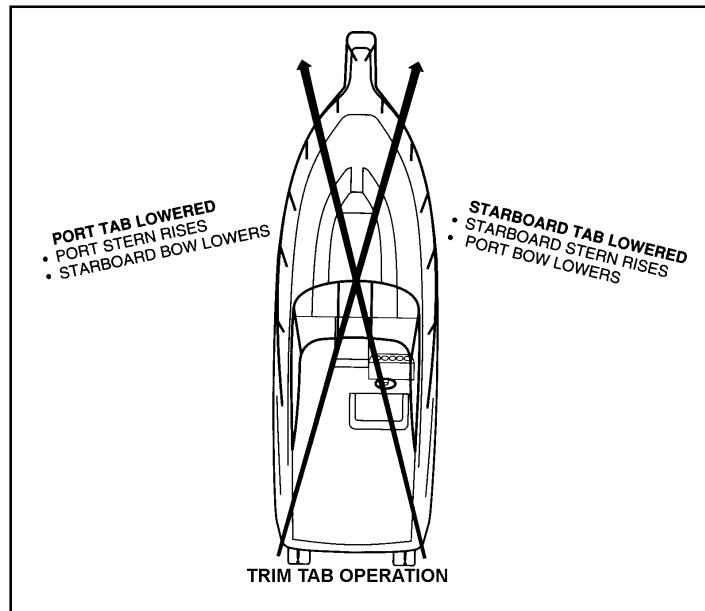
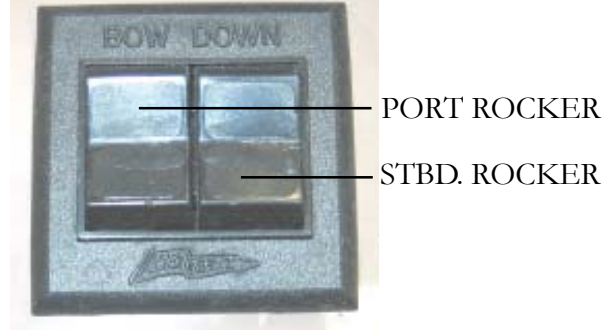

Using trim tabs in conjunction with the power trim will compensate for uneven weight distribution, listing, water conditions, and other factors that cause inefficient operation. Remember, that trim tabs are trimming the hull while power trim is trimming the engine drive.

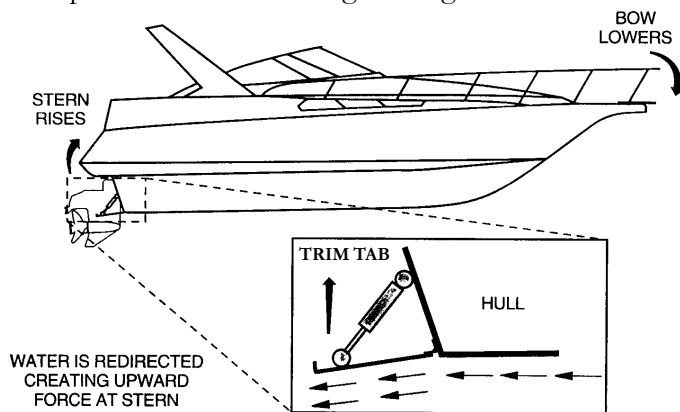

Obtaining A Trimmed Position

Your vessel will reach a planing position at a specific speed. This speed is determined by bottom design, weight distribution, water conditions, and on board equipment. As the throttle is advanced the stern squats and the bow rises initially. The trim tabs allow your boat to plane at a slower speed than natural conditions allow.

In short bursts both trim tab rocker switches are pushed simultaneously in the “bow down” position which causes the trim tabs to move down. As the boat breaks over the bow high attitude the boat speed accelerates and visibility increases.

If the boat is overtrimmed, it will plow the bow and the boat will lose maneuverability. If this occurs, simply short burst the “bow up” trim tab rocker switch simultaneously.

In the “learning curve” process, press the tab switches in half second bursts. You will notice a slight delay from the time the switches are pushed until the boat reacts depending on vessel speed. You will know after awhile the optimum planing angle and speed.

When running in heavy seas press the “bow down” position which will assist the vessel to cut through the waves. This will produce a drier and more comfortable ride. In a following sea run the tabs in a fully retracted angle for maximum outdrive response.

Sometimes you can watch the bow spray or stern wake and the rooster tail (mound of water produced by stern drives). In a bow up position the spray is far aft to the hull, the wake is high and the rooster tail is high.

When trimmed or in the bow down position, the bow spray is farther forward, the wake and rooster tail are smaller, and positioned further behind the vessel. Also, when trimmed you will notice that the tachometers show an increase in rpm's.

Rectifying A List

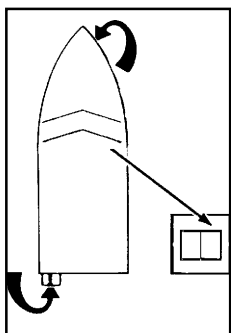

Your vessel can use the trim tabs to rectify a list. The trim tabs adjust the boat's attitude in the direction the helm rocker switch is pushed.

If the port bow is high, push the left-hand "bow down" direction on the dash rocker and the port bow will lower. If the starboard bow is high, push the right-hand "bow down" direction and the starboard bow is

lowered.

Using Stern Drive Power Trim With Trim Tabs

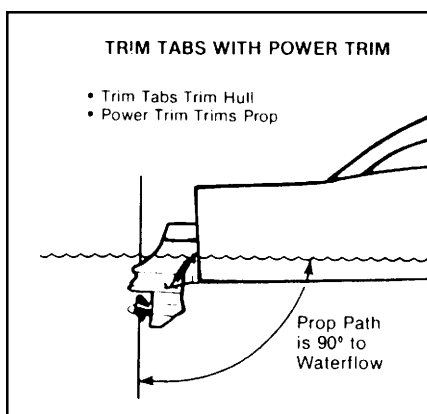

Adjust the *trim tabs* to achieve a planing attitude. Use the power trim to position the prop path parallel to the water flow. At this point the trim tabs may need a fine adjustment.

One advantage of the trim tab system is that they allow trimming of the hull while the power trim results in trimming the props.

Porpoising

Porpoising is a running condition where the bow "bounces" up and down similar to a porpoise's swimming motion. This condition is normally caused by the trim being too far "up" as indicated on the trim gauge. Press "bow down" in one-half second bursts and the porpoising should recede and the vessel speed should increase. Only a small amount of "bow down tab" is normally necessary to make the vessel bow actually go down.



WATER/WASTE SYSTEM

Fresh Water System

Your vessel is equipped with a fresh water supply system. It consists of a fresh water tank, deck fill, vent, monitor system, pressure water pump with filter, distribution piping system, dockside water pressure regulator and water heater. The system holds fresh water until it is needed. With the pressure pump energized the system will supply water to the galley, head, and accessories such as transom shower. The system is winterized from the factory utilizing a product called “freeze ban”. It is best to completely drain the freeze ban before adding any water to the tank in order to minimize the taste of Freeze ban. Freeze ban will not harm you but it does have a peculiar taste. The system requires little maintenance except occasional cleaning of the water filter and winterizing during cold weather. For more specific information on the water system see the equipment operation and troubleshooting chapters.

Waste Water System

Your vessel is equipped with various devices that make up the waste water system. They may include the toilet, overboard discharge pump (optional), shower sump pump, monitor gauge, waste tank, deck fittings, drains and seacocks. For more specific information on the waste system see the equipment operation, troubleshooting and maintenance chapters.

Vessel Operation



This chapter explores the many facets of running your vessel from casting off to docking and handling emergencies. We cover the basics but suggest you read other information on the chapter topics.

Also, become familiar with your engine owner's manual since many of the items discussed are found there in further detail.

GETTING UNDERWAY

PRE-DEPARTURE QUESTIONNAIRE

- Have all fluid levels been topped off?
- Is the fuel tank full?
- Are the engines, transmissions, and propellers in good condition?
- Is the drain plug in place (Dry stored vessels)?
- Have all passengers been briefed on all emergency procedures and seated for departure? Is the boat load balanced?
- Is all safety equipment accounted for and easily accessible?
- Are navigation lights and horn in good working condition?
- Is the bilge free of water and do the bilge pumps operate?
- Is the operator sober, alert and ready to skipper the vessel?
- Have all passengers been fitted for life jackets?
- Has a float plan been filed and left with a competent person?
- Has the bilge been sniffed and the fuel system leak checked?
- Are the appropriate seacocks open?
- Is all communication equipment in good operating condition?
- Has a second person been briefed on operational procedures should the skipper become disabled?



- Are all gauges and electrical switches functioning properly?
- Has weather information been gathered and analyzed?

UNDERWAY QUESTIONNAIRE

- After casting off have all dock lines and fenders been stowed?
- Are all passengers seated?
- As skipper are you monitoring the dash gauges for changes?
- As skipper are you on the lookout for changing weather?
- As skipper are you checking for abnormal vibration or steering?

DISSEMBARKING QUESTIONNAIRE

- Have you removed the keys from the ignition and secured them?
- Have all systems been checked for leaks?
- Has the battery switch been turned to the “off” position?
- Are all storage compartments and seacocks closed?
- Has the fuel tank been filled enough to assist in preventing condensation?
- Is the vessel properly tied and covered with equipment stored?

DANGER

AVOID PERSONAL INJURY OR DEATH!
GASOLINE IS A HIGHLY FLAMMABLE
AND EXPLOSIVE MATERIAL.
PRACTICE “NO SMOKING” AND EXTINGUISH
ALL FLAMMABLE MATERIALS
WITHIN 75 FEET OF THE FUEL DOCK.

WARNING

AVOID SERIOUS INJURY OR DEATH
FROM EXPLOSION OR FIRE
RESULTING FROM LEAKING FUEL!
INSPECT ENTIRE FUEL SYSTEM
AT LEAST ONCE A YEAR.

WARNING

PREVENT INJURY OR DEATH!
USE ONLY APPROVED MARINE
REPLACEMENT PARTS
THAT ARE IGNITION PROTECTED.

HULL DRAIN PLUG

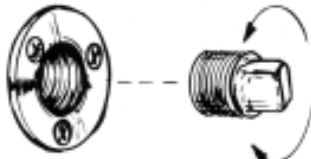

TIGHTEN-CLOCKWISE

Tighten the hull drain plug by turning clockwise.

Vessel Operation

NOTICE

GASOLINE IS AVAILABLE IN VARIOUS OCTANE LEVELS. REFER TO THE ENGINE MANUFACTURER'S OWNER'S MANUAL FOR CORRECT ONE FOR YOUR ENGINE. USING IMPROPER OCTANE FUEL CAN CAUSE ENGINE DAMAGE AND VOID THE WARRANTY.

BEFORE FUELING

- ☑ Make sure a working fire extinguisher is close.
- ☑ Stop engines and any device that can cause a spark.
- ☑ Disembark all passengers and crew not needed for fueling.
- ☑ Fuel if possible during the daylight hours.
- ☑ Check to ensure nobody is smoking in the boat or near the fueling dock.
- ☑ Close all enclosures to keep vapors from blowing aboard and settling in the bilge.
- ☑ Tie up your boat securely at the fuel dock.
- ☑ Identify the fuel fill.
- ☑ Inspect fuel system components before filling.
- ☑ Avoid using fuels with alcohol additives. They can attack and deteriorate fuel system components.

DURING FUELING

- Keep the fuel nozzle in contact with the fuel fill to guard against static sparks. The fuel fill pipe is grounded through the fuel system wiring to protect against static electricity.
- Avoid overfilling the fuel tank. Leave room for expansion.
- Avoid spilling any fuel. Clean up any fuel accidentally spilled with a clean rag and dispose of it properly.

AFTER FUELING

- Close all fuel fill openings tightly using the key.
- Open all hatches.
- Energize the blowers for a minimum of 4 minutes before starting the engine.
- Sniff in the lower bilge and engine compartment for gas fumes. If fumes are detected continue to ventilate until the odor is gone. Look for any traces of fuel droplets or spillage.

Do not start the engines, smoke or run any electrical components until fumes can no longer be detected.



STARTING & STOPPING

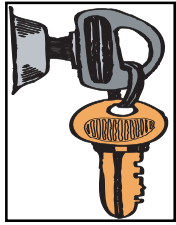

The following general information covers starting and stopping your engine. Read and understand all previous information on remote controls, fueling and operational procedures. Pay particular attention to all labels. Refer to the engine owner's manual for in depth propulsion

system information.

Review all pre-departure information. Before starting your engine make sure all canvas is removed and stored. Start the engines only in a well ventilated location to avoid CO buildup. Make sure all battery switches are activated.

Position the remote control handle in the neutral position. Advance the neutral throttle advance position as instructed in the engine owner's manual. Keep passengers seated and away from controls. Make sure the center windshield section is closed and locked.

STARTING GUIDELINES

The engine starts much like an automobile. Turn the ignition key to the "ON" position. Then turn the key to the spring loaded start position. You will hear the starter cranking the engine. When the engine starts release the key switch.

If the engine does not start, refrain from cranking the engine over 10-12 seconds. Allow the starter and battery a chance to recover. Advance the remote control in the neutral throttle position as recommended in the engine manual. Do not race the remote control in the neutral position.

Refer to the engine and control chapter and the manufacturer's engine owner's manual for additional information.

	WARNING
AVOID PERSONAL INJURY OR DEATH! WHEN ENGINE IS RUNNING TRANSOM DOOR MUST BE CLOSED AND LOCKED. SWIM PLATFORM AND LADDER MUST NOT BE IN USE.	

	CAUTION
TO AVOID ENGINE DAMAGE! CHECK THE OIL GAUGE IMMEDIATELY AFTER STARTING. IF LOW OR NO READING SHUT DOWN ENGINE IMMEDIATELY AND INVESTIGATE THE PROBLEM.	

	WARNING
GASOLINE VAPORS CAN EXPLODE! BEFORE STARTING ENGINE(S) OPERATE BLOWER(S) 4 MINUTES AND CHECK ENGINE COMPARTMENT FOR GASOLINE LEAKS AND VAPORS. RUN BLOWER BELOW CRUISING SPEEDS.	

Vessel Operation

SHIFTING GUIDELINES

Before shifting into reverse or forward make sure the coast is clear. When shifting to either gear from neutral make sure the throttles are in the idle position. Do not pause but engage the shifter quickly into the desired gear. Allow your vessel to lose all headway before shifting into reverse or forward gear. Practice shifting! You will become more familiar with the procedure and self-confidence will build especially in tight docking situations. Most importantly, stay alert!

CAUTION

**WHEN BOAT IS MOVING FORWARD
AND SHIFTED IN REVERSE,
COCKPIT CAN FILL WITH WATER.
BEFORE SHIFTING TO REVERSE,
SHIFT TO NEUTRAL AND WAIT FOR BOAT
TO STOP MOVING FORWARD.
WHEN VESSEL STOPS,
SHIFT INTO REVERSE.**

STOPPING GUIDELINES

Before stopping the engine make sure it is in neutral and at idle speed. After an outing let the engine cool down at idle speeds for a few minutes before turning the ignition off. Glance at the gauges one last time to monitor their readings. Never turn the engines off while in forward or reverse gear. *Never back up in reverse at excessive speeds since water could enter the engine through the exhaust system and cause extensive damage.* Above all, use common sense.

FENDERS

FENDER USAGE

Fenders are normally made of a rubberized plastic and are usually filled with air. Most have a fitting like a basketball so they can be inflated or deflated. Fenders are available in a wide range of sizes and shapes to fit both small and large vessels. Fenders are normally designated in inches. They are used between piers, docks, sea walls and the boat. They protect the topsides of the boat from rubbing against rough objects. Most fenders have eyes of attachment which allow a line to be inserted vertically or horizontally. This will permit the fender to be tied off to fit a variety of marina, dock and tidal situations. Be sure the fender is correct for the vessel size. It is a good idea to carry extra fenders but half a dozen is normally an acceptable number. Remember to store fenders on board so they can be easily accessed. Some people incorrectly call fenders “bumpers”.

FENDER TYPES



There is a variety of fender styles and types, each selected for specified uses. When choosing fenders, contact a marine dealer or supply house. Explain how you moor and use your vessel so they can recommend the best fender type for you. We suggest the type with a fill plug so you can inflate them with a hand pump like the ones used for bicycles.



DOCK LINE BASICS

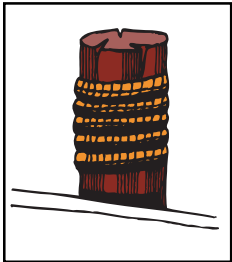

Most skippers use dock line terminology fairly loose but there is more to the basics than just bow or stern lines. There are several lines that can be secured to the bow and stern and depending on their direction and use, can be called other names. Remember that “forward”

and “aft” refer to the direction that a spring line runs from the vessel, and not where it is secured on board.

BOW & STERN LINES

There is only one true bow line. It is secured to the forward cleat and run forward along the dock to prevent the vessel from moving to the stern. The stern line leads from a rear cleat to a piling or cleat on the dock astern of the vessel. This line keeps the boat from moving ahead. For small vessels these are the only lines needed for normal wind and current conditions. If located in a tidal environment, keep slack in the lines.

BREAST LINES

These lines are attached to the bow and stern that lead to nearly right angles from the center of the vessel to the dock. They help keep larger vessels from moving away from the dock, or are pulled in to help people board the vessel. Bigger vessels may use bow or quarter breast lines.

SPRING LINES

Most small boats use two spring lines although it is possible to have four. They are called the after bow spring and forward quarter spring.

Bow springs are secured at the vessels’ bow area. Forward spring lines lead forward from the boat to the dock and control movement sternward. After springs stem aft from the vessel, and stop movement ahead. Spring lines are used to prevent movement in a berth, ahead or astern. They are really useful in controlling the effects of a real active tidal surge. Spring lines are useful where fenders need to be kept in place against piles.

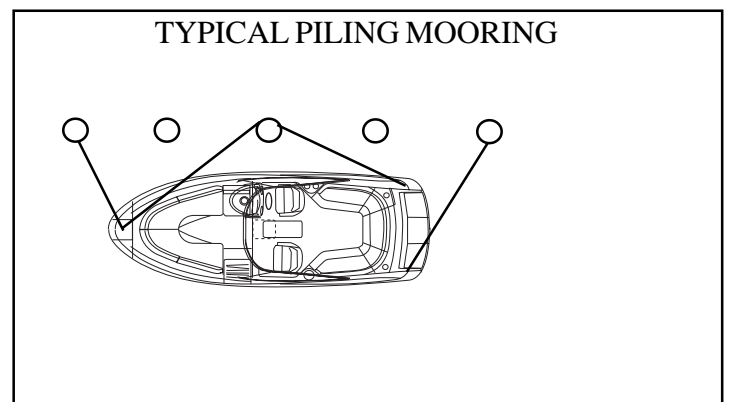
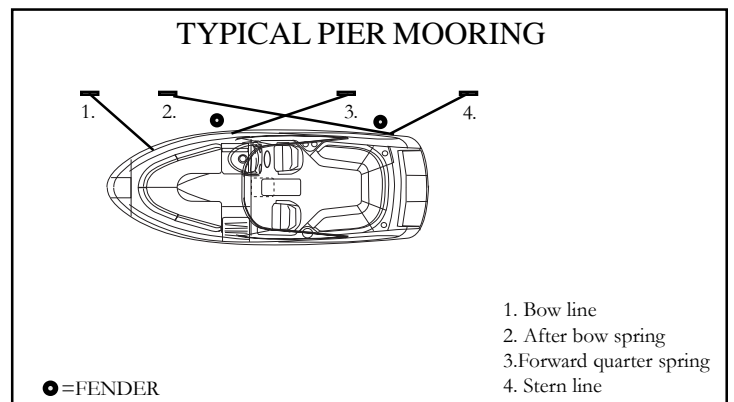

BOAT MOORING

Most boats can be secured to a dock using four lines. The after bow spring is crossed with the forward quarter spring and secured to individual dock cleats or pilings. This ensures longer springs and can be snugged up tighter for more efficient tidal control. Remember, if you only have one piling available, position the vessel so this point is opposite amidships. Run both spring lines to it. These lines will be shorter but still useful.

Vessel Operation

The bow and stern lines should be relatively at a 45 degree angle with the dock. The stern line can be attached to the near-shore quarter cleat, but will work more efficiently to the offshore quarter cleat. The longer line will allow the boat flow with the tide with less time checking the vessel.

DOCK LINE SIZING

Most dock lines today are made of nylon, either of twisted rope or braided core and cover. The most often used material is nylon because of its stretching abilities absorbing shock loads. It is chafe resistant for extended life and is easier on bare hands.

The line's size varies with the vessel. Normally, a vessel in the 20' to 40' boats will use 1/2" diameter nylon lines.

Dock lines need to have the strength to hold the vessel and have enough density to resist chafing. They shouldn't be too heavy that they lose their shock-absorbing capabilities. Use the right size line for the vessel since a line too large for the boat will pull hard against the vessel since it won't be forced to stretch. If the line is too small for the vessel, there is no margin for wear and chafe when under strain

SECURING LINES

When mooring your boat, make sure the dock lines are secured at both ends. Depending on your situation you may need to loop the eye splice of the dock line around a piling. Sometimes the mooring line will lead down sharply from the piling to the deck cleat. Loop the eye splice around the piling twice to keep it from being pulled up off the pile. Pull the line through the looped eye if the mooring line is too small to go around the piling twice or too small to fit over once.

If you must drop a line over a piling that already holds another boat's line, run the eye of the line up through the first eye from below, then loop it over the pile. This will allow either line to be removed without disturbing the other. If another line is dropped over yours, simply reverse the process.

Secure a little slack in the other dock line, then slip your eye up through its loop and over the top of the pile. Your line can be dropped through the other eye.

When debarking from a dock, it is easier to release the line from a cleat or piling, from on board the boat, as soon as you leave the dock. Loop a long line around the cleat or pier and leading both ends on board you can release the line easily. Slip one end around the cleat or pile, then pull it back on board. Release the line without the eye splice, so it will run freely from around the pile without hanging up on the splice.

	WARNING
AVOID SERIOUS INJURY FROM FALLING! ALL WET DECKS ARE VERY SLIPPERY! WEAR SLIP-RESISTANT FOOTWEAR, WALK ONLY ON DECK NON-SKID SURFACES. HOLD ON TO RAILS AND BOAT STRUCTURE WHILE ON THE DECK.	



STERN DRIVE DOCKING

Inboard/Outboard powered boats are fairly easy to back up and maneuver with a little knowledge and docking practice. One of the most important aspects of the process is to keep your calm in the wake of a busy marina. Basically, the reversing propellers are turned in the direction you want to go by using the steering wheel.

Some boats tend to be influenced by the wind. When backing down in a crosswind, allow room to maneuver and watch the bow. Try not to overreact or get excited, but use your knowledge and experience. If the wind begins to swing the bow, you need to stop backing, turn the wheel to port and go forward to straighten the boat. Use a quick burst of power but not too much to knock your crew off balance.

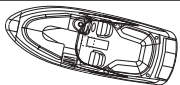

A. Stop the boat by shifting in reverse. Put the wheel over to the port and begin backing in. Slow down your speed by momentarily shifting into reverse.

** Control in reverse idle position, Outdrives to port.*

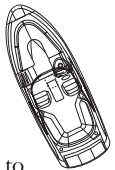

B. Continue backing up the boat with the wheel hard to port. Keep an eye on the bow, and begin to straighten the wheel as the boat enters the slip.

** Control in reverse idle position, Outdrives to port.*

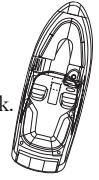

C. Center the wheel to align the boat parallel with the dock. If the stern is too far from the dock, shift to neutral, then put the wheel hard over to port and then go forward a second or two.

** Control in neutral idle position. Drives centered.*

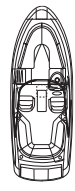

D. When the boat is completely into the dock, stop stern movement by shifting into forward. Put the wheel to port to kick the stern over close to the dock if necessary. Shift into neutral. Tie up the boat.

** Control in forward idle position. Drives to port.*

CAUTION

AVOID PERSONAL INJURY OR PROPERTY DAMAGE!

DO NOT USE THE SWIM PLATFORM CLEATS FOR TOWING OR ANY TYPE OF PERMANENT MOORING OR DOCKING.

USE BOW, STERN AND SPRING LINE CLEATS FOR MOORING AND/OR DOCKING.

Vessel Operation

STERN DRIVE MANEUVERING

Inboard/outboard, I/O or sometimes called stern drive boats do not have rudders. The boat uses a steering system that directs the propeller thrust, by turning the stern drive unit where the propeller is mounted. Normally maneuvering the I/O boat is easier than a V-drive vessel. Directing propeller energy (thrust) makes slower speed maneuvering easier. The propeller discharge current is turned from one side to the other which results in turning forces. Rudder boats need water to flow by the rudder to be efficient. Stern drive units are designed to have reduced shaft angle, so the propeller does not produce as much unequal blade thrust and resistance as does a propeller on a single screw boat. Large horsepower stern drive boats do produce more thrust and steering torque but your vessel has the advantage of power steering. Below is some basic information on how stern drive boats handle in normal conditions.

GATHERING HEADWAY

You may notice that if you advance the throttle quickly in initial takeoff (make sure you have a firm grip on the wheel), the boat has a tendency to pull the stern of the vessel to starboard. There is a trim tab (also serves as a sacrificial anode) located on the vertical drive housing just to the top of the propeller blade. This trim tab helps compensate for the low speed steering torque. Once the boat increases headway and the propeller is operating in a faster water flow this torque effect decreases. Contact your Regal dealer for further information or consult your engine manufacturer's handbook.

TURNING

Once the boat has gathered headway, with the boat planing at the correct bow angle and the stern drive units and helm straight the boat tends to stay on a uniform course heading. To assure the boat trim angle is correct use the trim gauge as a guide while activating the trim button on the remote control panel.

When the helm wheel is turned to the right (starboard), the stern drive unit is turned in the same direction. The propeller's discharge force is directed to starboard forcing the boat's stern to port. Water flowing past the hull strikes the stern drive gear housing on its starboard side, creating additional turning torque. The stern starts a move to port, forcing the bow to starboard.

If the helm is turned to the left or port the stern drive turns to port, the stern of the boat goes starboard as the bow turns to port.

As the vessel operator gains experience, he will better gauge each maneuver and speed situation. In this way he will understand the handling characteristics of his boat. He needs to keep the safety of his passengers in the highest priority.

BACKING DOWN

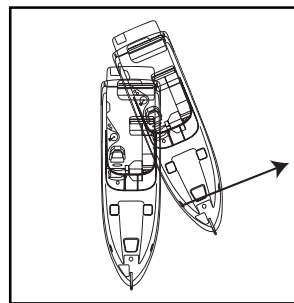

Inboard/Outboard (I/O) boats do not have rudders. The boat uses a steering system that directs the propeller thrust, by turning the stern drive unit where the propeller is mounted. Normally maneuvering the I/O boat is easier than a similar V-drive

vessel.

If your boat has the steering wheel and stern drives straight with the control in reverse, the stern will be pushed a bit to port by the reversing propeller thrust. This tendency to back to port can be eliminated by turning the stern drive to starboard.

When the vessel begins to gather speed to stern, the water passing by the lower gearcase housings will continue to increase steering torque. If the helm wheel is turned to starboard, and will direct the propeller thrust to port, tracking the stern to starboard.

Wind and current will affect how a vessel backs. Stern drive boats tend to be light displacements and when backing down in a strong crosswind, the bow will tend to fall toward the windward. This may require steering adjustments "on the run".



Once increased headway is gathered in reverse gear, the force of the lower hull moving through the water is enough to track straight. When backing, the stern will lead as it heads to port or starboard, before the vessel actually starts to turn. When the control is put in forward gear position, the stern is pushed to starboard; the amount of push depends on the hull design and the amount of throttle advance.

STOPPING

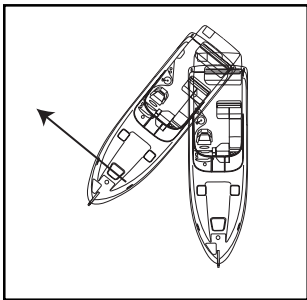

Remember that your boat does not have any brakes. It uses reverse thrust from the propeller to stop. If the vessel has headway, with the helm and propellers in reverse the propeller thrust is directed backwards, past the lower gearcase of the stern drive.

Depending on how far the throttle is advanced, the discharged thrust may not be strong enough to reverse the water flowing by the gearcase. As the power is increased, the propeller thrust becomes strong enough to stop the flow of water past the lower unit, and, as the throttle is advanced it reverses its flow more completely.

When water is flowing past the gearcase, steering torque is increased, but when the thrust stops the water flow, the boat will not respond to the helm. This is a short lived event and is overcome quickly when the water again flows past the gearcase. Furthermore, added to the energy of the water hitting the lower gearcase, the propeller thrust is directed by turning the stern drive, which can add to the steering torque.

The props tend to throw the stern to port. This is why experienced skippers undertake a portside landing when wind and current conditions permit. They allow the prop to move the stern to port toward the dock.

With a forward motion when the helm wheel is turned hard to one side, the vessel pivots around a point about 1/3 its length abaft to stern. See illustration.

ANCHORING



Selecting the correct anchor is an important decision. The anchor style in part depends on the usage and boat type. Regal boats designate an anchor type and or model. Some models incorporate chain, line with an optional windlass. Contact an authorized Regal

dealer for more information.

Anchoring is easier with another person on board. First be certain that the line for the anchor is properly attached, to avoid losing the anchor and anchor line overboard.

For most anchors to perform more efficiently, you should attach 3 to 6 feet of chain. The chain will stand up to the abrasion of sand, rock, or mud on the bottom much better than a nylon line. It should be galvanized to reduce corrosion. Next, attach a length of nylon line to the other end of the chain.

The nylon will stretch under a heavy strain cushioning the impact of waves or wind on both the boat and the anchor.

To anchor, select a well protected area, preferably with a flat bottom. Contrary to modern belief, you do not throw the anchor over while the boat is making headway, or moving forward. In fact, the bow of the boat should be bought slowly backward, while easing the anchor slowly over the side of the boat until it hits the bottom. To “snub the line” means to stop its outward “pay” or movement. Usually the length of anchor line used should be 5 to 10 times the depth of the water.

After you have anchored, check your position with landmarks if possible. You need to continue to monitor these landmarks to make sure you are not drifting. Since anchoring can also be an emergency procedure, the anchor and line should be readily accessible.

For increased holding power in windy conditions, two anchors are sometimes set. If your primary anchor drags, you can run out your secondary anchor without picking up the primary one. The important thing is to lay them out at an angle. When setting two anchors, make sure they are fastened to separate rodes or cleats.

Vessel Operation

This is done in case you need to adjust one later so the line is accessible. If two anchors are used ahead of a boat, make sure to set the rodes at an angle than in a straight line to reduce the chances of tangling as the boat moves in wind and current. See the above illustration.

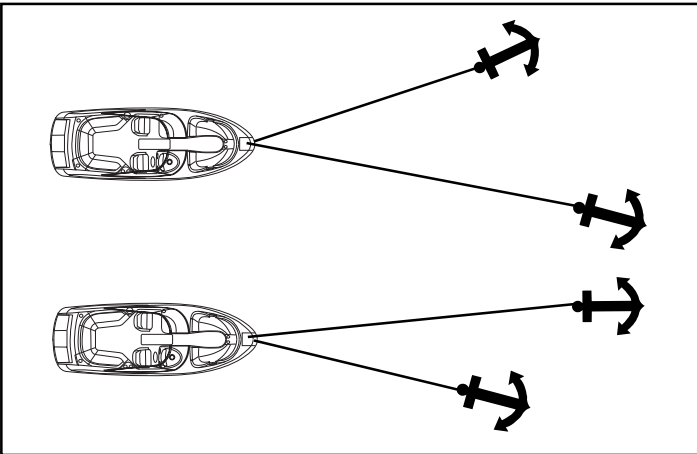

NOTICE

USE THE ANCHOR SAFETY HOOK TO HOLD THE ANCHOR SHOULD THE WINDLASS FAIL.
DO NOT USE THE SAFETY HOOK AS THE SOLE HOLD-DOWN SUPPORT FOR THE ANCHOR.

To anchor safely and correctly requires the use of RODE and SCOPE terminology. The **rode** is the line that connects the anchor to the boat. The **scope** is the ratio of the rode length to the distance vertically from the sea bottom to the bow.

A formula that may help you determine rode length is:

$$\text{Scope} = \frac{\text{Rode Length}}{\text{Bow Height} + \text{Water Depth}}$$

$$\text{Rode Length} = (\text{Bow Height} + \text{Water Depth}) \times \text{Scope}$$

Determining factors with Scope are type of anchor, wind and sea conditions, tide and type of bottom.

Minimum is 5:1 for calm conditions, average is 7:1 and severe weather conditions require 10:1.

An example of the formula is as follows:

$$\text{Rode Length} = (5 \text{ feet} + 20 \text{ feet}) \times 7$$

$$\text{Rode Length} = 25 \text{ feet} \times 7$$

$$\text{Rode Length} = 175 \text{ feet}$$



TOWING

In case you find yourself aground or in need of a tow, or should you want to tow another vessel, keep in mind that you **never use deck hardware or cleats to secure lines for towing!**

Deck hardware is intended for mooring and anchoring, and is not designed to withstand the strain and pull of towing. Rather than tie the line to your cleats on deck, it is suggested that you tie a bridle by passing a line completely around the hull of your boat to avoid structural damage. When towing, always stand clear of a taut line, as any type of line breaking under stress can be extremely dangerous. The preferred line for towing is double-braided nylon, as it has sufficient elasticity to cushion shock loads. Move slowly and cautiously.

 DANGER
AVOID SERIOUS BODILY INJURY OR DEATH! DO NOT USE DECK HARDWARE INCLUDING CLEATS FOR TOWING.

ADMIRALTY LAW

The Admiralty law sometimes referred to as the salvage law was founded primarily on English law fundamentals and basically says that a vessel distressed, in danger of flounder, if rendered assistance from a towing company or private agency, can be forced to relinquish a portion of the vessels' worth for the assistance received.

NOTICE
IN THE EVENT YOUR VESSEL IS IN DISTRESS, PRIOR TO ALLOWING ANY TOWING COMPANY OR PRIVATE AGENCY THE RIGHT TO PASS A LINE TO YOUR VESSEL, BE SURE TO ESTABLISH THAT YOU DO NOT AGREE TO ANY SALVAGE RIGHTS. ESTABLISH WITH THE CAPTAIN OR OPERATOR THAT YOU WISH TO BE ASSISTED IN A CONTRACT BASIS AND ESTABLISH A PRICE. OF COURSE IN CERTAIN SITUATIONS, YOU MAY NOT HAVE THIS OPTION. USE YOUR BEST JUDGEMENT!

Vessel Operation

KNOTS

Knots are useful in docking, towing and other emergency situations. Learning to tie knots requires practice. As they say “Practice makes perfect”. Some of the knots used in boating are the square, bowline, anchor bend, clove hitch, figure eight and half hitch. There are several periodicals available that explain various knots and how to tie them effectively. An experienced skipper will know the basic nautical knots and will use them when on the water. Take the time to know the basic knots.

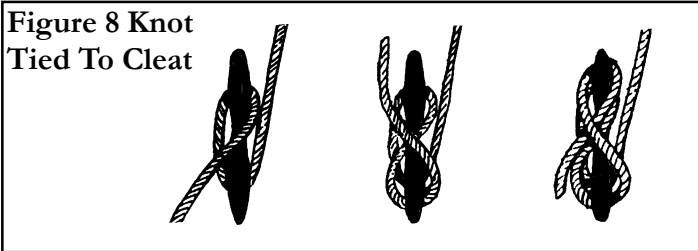

A useful knot to learn for general docking is the figure eight with one end reversed. By turning the free end of the line back under, the knot can be released without disturbing the boat. After some practice one person can secure a vessel easily to a dock or pier in a variety of weather conditions. This knot normally is used to tie the bow and stern. Then the vessel can further be fastened by tying the spring lines in the figure eight knot. Wrap it around the cleat 2 or 3 times.



EMERGENCIES

Always be ready to help others on the water if possible, but do not take any unnecessary risks. Use equipment to save a life, but do not risk a life to save equipment. Consult earlier information in this manual concerning accidents, etc. Also, read other literature concerning on the water emergencies. Be alert and prepared!

FIRE

Fire aboard a vessel can spread quickly and can cause tremendous alarm among everyone. Most fires can be prevented by keeping the bilge free from oil and debris. Keep all equipment stowed and maintained in working order. Carry a backup fire extinguisher on board. If something becomes a possible fire hazard, remove that possibility at once.

Never use water on gasoline, oil or electrical fires. When you dump water on an electrical fire a you can be shocked since water conducts electricity.

Follow these instructions if a fire breaks out:

1. Fit everyone aboard with a life jacket. Turn off the ignition.
2. Try to keep the fire downwind. If the fire is to the stern, head the bow toward the wind. If forward, put the stern to the wind.
3. If the engine should catch fire, shut off the fuel supply. Usually there is a fuel tank access that you can crimp the fuel feed line.
4. Use a hand fire extinguisher. Make sure to point it at the base of the flames. Use short bursts and sweep the extinguisher side to side. **Remember: (A 4 pound extinguisher discharges in 20 seconds)**

These actions help prevent the fire from spreading to other parts of the boat. You can extinguish fires quickly if you act swiftly. Have a plan of action in motion in case a fire breaks out.

FIRST AID

Knowing first aid can save lives. A first aid kit and the ability to use it are important ingredients for the safety of a skipper's passengers, crew and vessel. Having confidence and competence in handling medical emergencies on board is a must for the skipper. Invest your time in a first aid course available at the American Red Cross.

CPR (BASIC LIFE SUPPORT)

If someone is seriously injured have someone call for help while the injured person is being attended.

Check for possible danger signs; loss of breathing, unconsciousness, severe bleeding and heartbeat. If you determine the individual is not breathing or unconscious place the victim on their back on a hard surface and do the following:

1. If unconscious, open the airway. Neck lift, head lift or chin head lift.
2. If not breathing, begin artificial breathing. Pinch the nose. Give 4 quick breaths. If airway is blocked, try back blows, abdominal or chest thrusts and finger probe until airway is open.
3. Check for pulse. Begin artificial circulation. Depress sternum 2". Fifteen compressions rate 80 per minute. 2 quick breaths. Continue uninterrupted until advanced medical support is available.

Vessel Operation

HYPOTHERMIA

Hypothermia is a condition where the body temperature decreases because the body can't generate enough heat to maintain its normal temperature. It can be serious and usually occurs where victims have been immersed in water (under 68 degrees) for periods of time. If you encounter a possible hypothermia victim call for help on the radio and get the person out of the water.

Symptoms are:

1. Shivering that if condition is advanced may stop.
2. Confusion, clumsiness or slurred speech.
3. Rigid muscles.
4. Semiconscious to unconscious.

Treat hypothermia by the following:

- Remove wet clothing.
- Monitor the victim's pulse and breathing.
- Rapidly apply heat to the body core by using blankets, naked bodies or warm water.
- Do not give the person any food or drink.
- Do not warm the arms and legs. Warming of these extremities can be fatal.

Follow up immediately with medical authorities!

ENVIRONMENTAL AWARENESS

There are numerous vessels operating on our waterways on a daily basis. Each boat has an impact on our environment. Boat operation habits, marine sanitation, and maintenance all play a role in a delicate battle to keep the ecosystem clean. Each of us has a role in doing our part as an environmentally conscious skipper to conserve our waterways.

The National Marine Manufacturer's Association lists their top ten of Eco-Boating Practices as follows:

1. Observe all regulatory agency policies regarding marine toilets.
2. If equipped with a holding tank, use marina pump-out facilities.
3. If used, make sure bottom paints are legal and ecosystem friendly.
4. Use only biodegradable cleaning agents.
5. Dispose of all garbage and litter on shore properly, not on the water.
6. Do not top off fuel tanks. Leave expansion room. Clean up spills.
7. Watch your wake and propeller wash.
8. Make sure your engines are well tuned and maintained.
9. Control your bilge water.
10. When fishing, practice the "catch and release" principle.

Follow these basic practices when on the waterways. Treat the environment in a way that you would like to be treated.



CALIFORNIA AIR RESOURCE BOARD (CARB) LABEL

Your Regal boat may have a star shaped label affixed to the bow, port hullside. It is located at the front of the state registration numbers. This label is part of the California Air Resource Board (Carb) SD/I rule. If your boat is operated in the state of California and/or bordering waters, this label **MUST** remain intact. The label shows that the engine installed as original equipment meets a currently approved California state regulatory emission level. See the example below which shows the current California ultra low 3 star label.



CARB LABEL

CALIFORNIA PROP 65

Proposition 65 relates to the state of California and is an additional requirement added to their Safe Drinking & Toxic Enforcement Act of 1986. Prop 65 basically summarized states that:

“No person in the course of doing business shall knowingly discharge or release a chemical known to the state to cause cancer or reproductive toxicity into water or onto land where such chemical passes or probably will pass into any source of drinking water” and it goes on to say “no person in the course of doing business shall knowingly and intentionally expose any individual to a chemical known to the state to cause cancer or reproductive toxicity without first giving clear and reasonable warning to such individual”

For more information, contact the California Office of Environmental Health Hazard Assessment at 916-445-6900 or <http://www.oehha.ca.gov/prop65.html>.

WARNING

A wide variety of components used on this vessel contain or emit chemicals known to the State of California to cause cancer and birth defects and other reproductive harm.

EXAMPLES INCLUDE:

- * Engine and generator exhaust
- * Engine and generator fuel, and other liquids such as coolants and oil, especially used motor oil
- * Cooking fuels
- * Cleaners, paints, substances used for vessel repair
- * Waste materials that result from wear of vessel components
- * Lead from battery terminals and from other sources such as ballast or fishing sinkers

TO AVOID HARM:

- * Keep away from engine, generator, and cooking fuel exhaust fumes.
- * Wash areas thoroughly with soap & water after handling the substances above.

FUEL SPILLAGE

The federal water pollution control act prohibits the discharge of oil or oil waste (such as from the sump bilge pump) into or upon the navigable waters of the United States or the waters of the contiguous zone. Violators are subject to substantial civil fines and criminal sanctions.

A placard is placed inside the engine hatch area or in the sump warning of overboard discharge of oil or oily waste.

MARPOL TREATY

The USCG now enforces the International Convention for the Prevention of Pollution from ships, referred to commonly as the MARPOL TREATY (marine pollution). This international treaty prohibits the overboard dumping of all oil, garbage, ship-generated plastic and chemicals. There is a placard on board your boat that explains the garbage and plastic dumping laws in detail. Normally this placard is found near a waste receptacle in the cabin or cockpit.

Chapter 7

Equipment Operation

Your Regal vessel features many standard and optional equipment components. ***For the most in depth information, refer to that particular equipment manufacturer's manual located in the owner's document pouch.***

Equipment or vendors may change during a boat's life cycle. *Therefore, some of the components discussed here may or may not be on your vessel or look the same visually or in description form.* Regal retains the right to change vendors, equipment, specifications and other technical data at any time.





INTERIOR EQUIPMENT

AIR CONDITIONING OVERVIEW



If equipped, the marine air conditioning system included in this chapter applies only to factory installed equipment. The air conditioner relies upon a source of AC power supplied by shorepower along with a supply of water (salt or fresh). The unit output is 7,000 BTU'S.

The unit features the ability to provide heat in a reverse cycle mode especially useful in extending the boating season in colder climates. This reverse cycle operation can be affected by the temperature of the water.

As the water temperature decreases so does its ability to produce heat. It is recommended that the reverse cycle not be used when the water temperature is below 40 degrees Fahrenheit.

Note that the air conditioning system can be used while cruising through the generator. As optional equipment the generator supplies alternating current to operate the air conditioner. Once the generator is started, use the transfer switch to distribute current from the generator to the various A.C. components on the ship's main electrical panel. Once the transfer switch is activated, energize the shore power main breaker on the main ship's panel. Make sure all equipment breakers are off before using the transfer process.

AIR CONDITIONER BASIC OPERATION

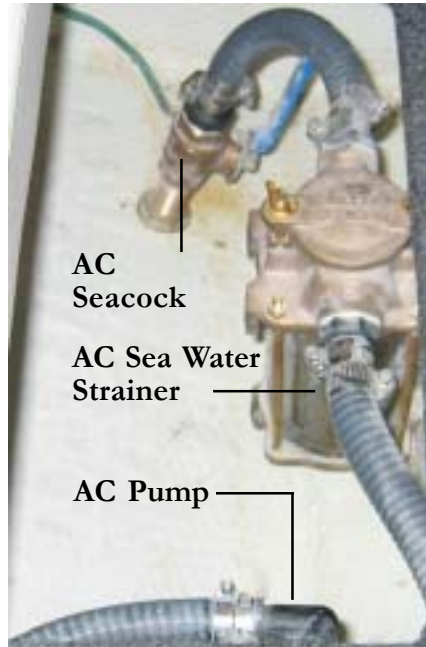

1. To use the air conditioner locate and open the through-hull seacock valve that supplies water to the air conditioner pump. The A/C seacock and pump are located beneath the cabin floor.

2. A strainer is installed between the seacock and the AC pump. This strainer stops foreign matter from being ingested

into the A/C pump or air conditioning system. Periodically inspect and clean the strainer.

3. To activate the air conditioning system while at dockside make sure *the* shorepower cord is plugged in and the dockside along with the shore power inlet breakers are energized. Refer to the systems chapter for more information. You need to monitor the A.C. current load meter as you energize various circuits especially using the air conditioner on the shore power cord system.

4. Activate the air conditioner breaker on the main A.C. control panel.

5. Press the "power" button momentarily on the Elite control display panel.

6. At this point follow the basic elite operation on the next page.

Equipment Operation

7. Press and hold the temperature buttons for the desired cabin temperature. Press either button momentarily to show current set point. Temperature range is from 60 to 85 degrees.

8. Check for a solid stream of water from the overboard discharge.

9. Make sure there is steady air flow out of the air supply grille.

NOTICE

**AVOID POSSIBLE EQUIPMENT FAILURE.
DO NOT TURN THE UNIT OFF & ON
IMMEDIATELY. ALLOW AT LEAST 30
SECONDS FOR REFRIGERANT
PRESSURE EQUALIZATION.**

10. The air conditioning system is programmed can be programmed for various operating modes. See the vendor supplied owner's manual for changing the modes on the elite control display panel.

11. Do not block the intake grill. It provides continued air for the air conditioning system. Clean the filter monthly.



2.0 Elite Controls • Basic Operation

2.01 Operator Controls and Display Panel

1-POWER BUTTON The Power Button is used to toggle between the On and Off Modes. Press the Power Button once to toggle the unit to the On Mode.

2-UP BUTTON Momentarily press and the set point will appear in the display. Press and hold the Up Button the set point will scroll to the upper limit. The set point increases one degree each time the Up Button is pressed and released.

3-DOWN BUTTON Momentarily press and release to display the set point. The set point is decreased one degree each time the Down Button is pressed and released. Press and hold the Down Button and the set point will scroll to the lower limit.

4-FAN BUTTON Press and release the Fan Button to advance from auto fan to manual fan. Press and release the Fan Button to advance the manual fan speeds, from low to high. Press and release again to return to the automatic Fan Mode. The selected Fan Mode is indicated by the Auto and Manual Fan LEDs. The fan operating mode can be changed from continuous ("con") to cycle-on-demand ("CYC") by pressing and holding the fan button for 5 seconds.

5-MODE BUTTON The Mode Button is used to select one of the four operating modes. Press and release the Mode Button and the Elite will advance to the next mode. Continue to press and release the Mode Button until the desired operating mode is reached. The mode selected is indicated by the Mode LED, i.e., Cool, Heat, Automatic or Moisture Mode.

6-THREE DIGIT SEVEN SEGMENT DISPLAY The inside air temperature is displayed in the window whenever the control is turned on.

The display also indicates program information, fault codes and outside air temperature when the optional outside air sensor is installed.

The display momentarily indicates the set point when the Up or Down Button is pressed.

When the control resumes operation after a power interruption all the Display LEDs will turn on for one second. This is a normal operating condition and is referred to as Power On Reset.

7-MANUAL INDICATION One of the three fan LEDs will be lit when manual fan operation is selected.

8-AUTO FAN LED The Auto Fan LED is illuminated when automatic fan speed operation has been selected.

9-AUTO MODE LED When the Auto LED is lit the unit will automatically switch to heating or cooling when required.

10-COOL MODE LED The Cool Mode LED will be lit when Cool Mode is selected or the unit is in a cooling cycle.

11-HEAT MODE LED The Heat Mode LED will be lit when Heat Mode is selected or the unit is in a heating cycle.

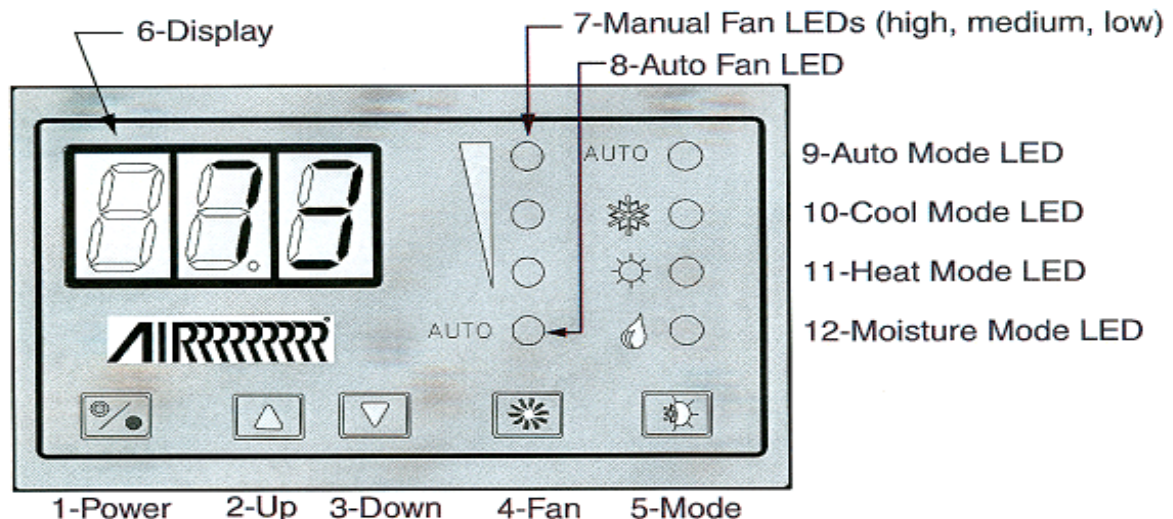

Equipment Operation

12-MOISTURE MODE LED The Moisture Mode LED is lit when the Moisture Mode has been selected. This mode is used to control humidity during periods when the vessel is unoccupied.

2.02 Special Button Functions

Service History Log... View the service history log by pressing the Mode Button immediately after turning on the AC power, and while all LEDs are illuminated. Exit the service history log by pressing the Power Button once. Simultaneously pressing the Power and Down Buttons while viewing the Service History Log clears the Service History Log. See the Service History Log section.

Self Test Program... Press the Power Button immediately after AC power is applied, and while all LEDs are illuminated, to enter the self test program. The self test program is used to diagnose problems and test the air conditioning system. For complete details see the Automated Factory Self Test Program section in this manual.

View Hour Meter... To view the compressor hour meter, press the Down Button immediately after applying AC power, and while all LEDs are illuminated. Maximum recorded time is 65,535 hours. The hour meter functions are described fully in the Service Tools section of this manual.

2.03 Dual Button Functions

Up & Down Buttons... Press the Up and Down Button together and the outside air temperature will be displayed, providing the optional outside air temperature ("OAT") sensor has been installed. No programming is required.

Press the Up & Down Buttons simultaneously, while in the Program mode, to set new custom programming defaults.

Press the Power & Up Buttons to view the service sensor temperature. P-8 must be turned on.

2.04 Modes of Operation

Off Mode

When the Elite is in the Off Mode, all control outputs are turned off. Program parameters and user settings are saved in nonvolatile memory. The Program Mode can only be accessed from the Off Mode.

On Mode

When the control is in the On Mode, power will be supplied to the appropriate control outputs and the display will indicate the current state of operation. The operating and program parameters resume based on those stored the last time the unit was operating.

Cool Mode

When the Cool LED is lit, only the cooling systems are selected and operated as required. When the temperature drops below the set point, the system will not automatically switch to the Heat Mode.

IMPORTANT NOTE TO END USER:

If your air conditioning unit is Cool Only - if it does not have a reversing valve - then Cool Mode **MUST** be selected. **DO NOT** set to Automatic Mode for a Cool Only unit. If Automatic Mode is selected and the thermostat calls for heat, the compressor will run. Since there is no reversing valve, the air conditioning unit will supply cool air when heating is desired. Cool Only units do not heat.

Heat Mode

When the Heat LED is on, only the heating systems are selected and operated as required. Should the temperature rise above the set point, the system will not automatically switch to the Cool Mode.

Automatic Mode

When the Automatic LED is on, both heating and cooling is supplied as required. The Heat or Cool LEDs will be lit when the unit is heating or cooling.

Temperature in a given mode will be maintained within 2°F (1.1°C), however, a 4°F (2.2°C) difference is required to allow the control to change modes. Once in a new mode, the temperature will remain within 2°F (1.1°C) of the set point.

Do not select Automatic Mode if air conditioning unit is Cool Only (see above).

Moisture Mode

While in the On Mode, press the Mode Button until the Moisture Mode LED is illuminated. Every four hours, the fan is started and air circulated for thirty minutes. During this time the air temperature is sampled and entered into memory. The cooling cycle is started and continues until the temperature is lowered 2°F (1.1°C). The compressor is allowed a maximum of one hour running time to reach the desired temperature. Four hours after the temperature is satisfied, or the compressor times out, the cycle will be repeated.



2.05 Fan Modes

Automatic Fan Speeds

Elite has three automatic fan speeds available: high, medium and low. Automatic Fan Mode allows the Elite to determine the required fan speed based on temperature differential. This permits a balance between the most efficient temperature control and slower, quieter fan speeds.

Manual Fan Mode

There are three fan speeds available: low, medium and high. Manual Fan Mode allows the user to select and maintain the desired fan speed manually. When a manual fan speed has been selected, the speed is indicated by one of the 3 LEDs above the AUTO fan LED. The top LED represents the fastest speed.

Fan Only Mode

The Fan Only Mode can be operated for air circulation when no cooling or heating is desired. From the Off Mode press and release the Fan Button to start fan speed one. Press and release again to select speed two. Press and release a third time for speed three. Press and release a fourth time to turn off the fan. Starting a cycle will revert the fan to the Automatic Mode or the last selected manual fan setting.

Cycle Fan With Compressor

Press and hold the Fan Button for five seconds. The mnemonic "CYC" followed by "con" will appear in the display. Release the button with "CYC" in the window and the fan will cycle on and off with the compressor. Release the button with "con" in the window and the fan will run whenever the system is on.

2.06 Program Mode

The Program Mode is used to adjust the systems operating parameters to suit the particular needs of individual users. The Program Mode is also used to tailor the air conditioning system for the most efficient operation within an installation. Installation variables such as, ducting, sensor location and system layout affect the perceived operation of the overall system. Elite is shipped with factory programmable default settings which are stored in memory and can be recalled. However, reprogrammed settings can be saved as the new default, thus overwriting the factory defaults (see programmable parameter P-15).

Entering Program Mode

The Program Mode can only be entered from the Off Mode. From the Off Mode and in the following order, press the Mode, Up, Down and the Mode buttons. These buttons have to be pressed and released in the order given. The numerals "85" which represent the high fan limit, appears in the display. The "85" is followed by the characters "P 1" followed again by the parameter setting "85". "P 1" represents the first programmable parameter. The Elite control is now in the Program Mode.

Restore Default Settings

IMPORTANT ! The default settings can be restored by entering the Program Mode and setting P-15 to "rSt". Exit the Program Mode and the software version number appears in the display. The default settings are restored and the Elite control returns to the Off Mode. The software version number is always displayed when you exit the Program Mode.

Using the Program Mode

Increment from one parameter to the next by pressing and releasing the Mode Button while in the program mode. Decrement from one program parameter to the previous one by pressing the Fan Button. Use the Up and Down Buttons to change the program parameter values. The programmable parameters range from P-1 through P-19. See the Programmable Parameters Table.

Up and Down Buttons

The Up and Down Buttons are used to select the data or set the desired limits for the parameter being programmed. This method is followed throughout the Program Mode, however, special instructions are included for individual functions as required.

Exiting the Program Mode

There are two methods to exit the Program Mode. Press the Power Button and the Elite control will return to the Off Mode. Not pressing any buttons or attempting any program changes for 50 seconds will allow the control to exit the Program Mode to the Off Mode. Any programming changes that were made while in the Program Mode will be memorized, set as the new default, and put into operation when the Program Mode is exited and the control is returned to the On Mode.

Software Identification

The software version of the control is identified for one second prior to the exit from Program Mode. The software identification number (i.e. "A13") will appear in the display for one second, then the control will return to the Off Mode.

NOTE: Should there be any reason to contact Dometic about the system or programming the Elite, be sure to

Equipment Operation

Programmable Parameters Table

Program Number	Description	Default	New Default*	Range
P-1	High Fan Speed Limit (arbitrary units)	95		56 - 95
P-2	Low Fan Speed Limit (arbitrary units)	50		30 - 55
P-3	Compressor Staging Time Delay	15		5 - 135 seconds
P-4	Temperature Sensor Calibration	Ambient		Ambient \pm 10° F
P-5	FAILSAFE LEVEL	3		0 1 = Continuous No Display 2 = Continuous W / Display 3 = 4 Failures Reset Required
P-6	Low Voltage Monitor ¹	OFF		OFF 95=95VAC for 115VAC Input Power 195=195VAC for 230VAC Input Power
P-7	De-Icing Cycle ²	1		OFF 1=On w/ 5°F Display Sensor Differential 2=On w/ 7°F Display Sensor Differential
P-8	Pump Sentry... Protects Pump and Compressor From Loss of Sea Water.	OFF		OFF On = Select 100°F to 150°F
P-9	Display Brightness Control	15		4 = Low 18 = Maximum
P-10	Display ° Fahrenheit or ° Celsius	°F		°F = Fahrenheit Displayed °C = Celsius Displayed
P-11	Cycle Pump With Compressor or Continuous Pump	CYC		CYC = Cycle with Compressor con = Continuous Pump
P-12	Reverse Fan Speeds During Heating Mode	rEF		nor = Normal Fan Operation rEF = Reversed Fan In Heating
P-13	Reverse Cycle Heating or Electric Heat Only Option Installed (cooling only units)	nor		nor = Reverse Cycle Heating ELE = Electric Heater Installed
P-14	Fan motor type selection. Shaded pole or split capacitor.	SP		SP = Shaded Pole Fan Motor SC = Split Cap. Fan Motor
P-15	Reset Memorized Programming Defaults	nor		rSt = Reset Defaults
P-18	Air Filter Cleaning/Replacement Timer Setting ¹	0		100-2500 hours (displayed in hours/10) 0=Timer Disabled
P-19	Air Filter Cleaning/Replacement Timer Value & Reset ¹	0		Displays the elapsed time (in hours/10) since the timer was started or reset. Pressing Up or Down resets the value to 0, restarts the timer, and clears the "FIL" reminder.

¹ This feature is only available in software revision A15 and newer.
² This feature's setting and behavior were modified in software revision A15 and newer. See feature description in text for more details.

*** Default parameter settings may be reprogrammed by user, enter new default settings in this column. Should any programming problems or confusion occur, reset the Default Settings by entering the program mode and setting P-15 to "rSt".**



have the software identification number and the air conditioning unit serial number available. The serial number may be found on the dataplate label.

2.07 Programmable Parameters

There are 17 programmable parameters with their Factory Default Settings listed in this section. The table below indicates what these parameters are, along with the permitted values and the original Factory Default Settings.

P-1: High Fan Limit

The upper fan speed limit can be adjusted for various motors. The high fan limit is adjusted with the system installed and operating. The values range from 56 through 95 arbitrary units. Set a higher number for a higher fan speed. Set lower number to lower the fan speed. Use the Up and Down Buttons to select the desired speed.

P-2: Low Fan Limit

The low fan limit determines the lowest output allowed for the low fan speed. The values from 30 through 55, arbitrary units. Use the Up and Down Buttons to select the low fan limit. Set a higher number, for higher fan speed. Setting lower numbers lowers the fan speed.

IMPORTANT ! Once the high and low fan speed limits are set, the unit will automatically readjust the remaining speeds to produce three equally spaced fan speeds in both Automatic and Manual Fan Modes.

P-3: Compressor Staging Time Delay

The compressor staging delay is provided for installations where more than one system is being operated from the same power source. Setting the staging delays at different intervals allows only one compressor to start at a time. The units should be staged at least five seconds apart. The minimum delay is five seconds and the maximum is 135 seconds.

P-4: Temperature Calibration

Use this feature to calibrate the air sensor within a range of $\pm 10^{\circ}\text{F}$. Enter the Program Mode and the ambient temperature appears in the display. Use the Up and Down Buttons to select the desired offset. The temperature in the display will increase or decrease according to the offset programmed. Note that setting increments are in $^{\circ}\text{F}$ even when the control is set to display $^{\circ}\text{C}$.

P-5: Failsafe Level

See Failsafe and Fault Handling Codes section.

P-6: Low Voltage Monitor

The Elite has a built-in voltmeter circuit that monitors the AC input voltage. Depending on whether the input power supply is 115VAC or 230VAC, this parameter can be set to "OFF", to "95" (for 115VAC input power) or to "195" (for 230VAC input power). The factory default setting is OFF.

When this parameter is set to 95/195, the Elite will check the AC input voltage prior to beginning every cooling or heating cycle and will prevent the compressor from starting if the voltage is less than 95VAC/195VAC. This provides extra protection for the compressor and components within the system during low voltage (brownout) conditions. If this low voltage condition occurs, the fault code "LAC" will show on the LED display. The fault will continue until the AC input voltage rises above 95VAC/195VAC, at which time the LAC fault code will clear automatically and the cooling or heating cycle will commence.

After the compressor is started, the low voltage monitor will not interfere with operation and the LAC fault will not be displayed even if the voltage does drop below 95VAC/195VAC. Similarly, whenever the Elite is not running a cooling or heating cycle and the voltage drops below 95VAC/195VAC, the LAC fault will not be displayed.

P-7: De-icing Cycle

Elite is equipped with a de-icing cycle to prevent ice build up on the evaporator coil during extended periods of cooling operation. Installation variables such as grille sizes, length of ducting, insulation R factors and ambient temperatures determine the cooling run time required to achieve set point. Customer usage may substantially increase run times by operating the system with the hatches and doors open. Programming an unrealistic set point (e.g. $65^{\circ}\text{F}/18.3^{\circ}\text{C}$) and leaving the salon door open will usually cause the evaporator to ice up on warm humid days.

For Elite software revision A13 and older, de-icing is accomplished by switching the reversing valve into the Heat Mode while the system is cooling. The valve will remain energized for the programmed cycle time. The cycle is programmable to "OFF" or to a period of one, two, or three minutes.

For Elite software revision A15 and newer, de-icing is accomplished using a more sophisticated algorithm that closely monitors the room air temperature in repeating 10-minute intervals during a cooling cycle. Depending on the value and change in room temperature during these monitoring intervals, the Elite will perform various actions to prevent ice from forming and/or melt ice that may have already formed. This is accomplished by short compressor shutdown periods combined with a one-speed increase in fan speed, and by periodic Heat Mode cycles with the fan turned off.

Equipment Operation

This de-icing feature is turned ON by default with programming parameter P-7 set to "1". The behavior of the feature is always the same whenever an optional alternate air temperature sensor is installed. However, the feature has two different, selectable behavior modes when it is used in conjunction with the Elite display's built-in room air temperature sensor. It attempts to compensate for any temperature discrepancy that the display sensor may experience. Although this discrepancy is not typical, installation variables such as where the Elite display is placed inside the room (e.g. near an open door or in direct sunlight) can affect how accurately it can read the actual room temperature.

By default with P-7 set to "1", the algorithm is applied assuming the display sensor may be reading the room temperature as much as 5°F (2.8°C) greater than the actual evaporator temperature. With programmable parameter P-7 set to "2", the temperature differential that is applied to the display sensor reading is increased to 7°F (3.9°C) for even more extreme installations. Setting P-7 to "2" should only be used if a setting of "1" does not prevent evaporator ice from forming. Alternately, the installation of an optional alternate air temperature sensor (located in the return air path) will greatly increase the effectiveness of the de-icing feature, and this option should be considered whenever the display sensor cannot read the room temperature accurately.

P-8: Optional Pump Sentry

Elite can be equipped with an optional temperature sensor that is used to monitor the condenser coil temperature. The sensor is plugged into the "SERVICE/H2O" sensor jack and parameter P-8 programmed for a temperature between 100 and 150° F (37.8 and 65.6° C), depending on seawater temperature and the system type. When the coil temperature rises above the programmed value the pump and compressor are shut down and "PLF" is flashed in the display. Connect the water sensor to the condenser coil outlet and insulate it. Note that setting increments are in °F even when the control is set to display °C.

P-9: Display Brightness Control

The display brightness can be adjusted to suit ambient cabin lighting conditions. The allowed settings are 4 to 18, with 4 being the dimmest and 18 the brightest. Typically a dark cabin will require a setting of 4 or 5. A very bright cabin will require a setting of 12 to 18.

P-10: Fahrenheit or Celsius Selection

The unit can be programmed to display either Fahrenheit or Celsius. Programming °F selects degrees Fahrenheit and programming °C displays degrees Celsius. The factory default setting is °F. When degrees Celsius (°C) is selected the readings are displayed in tenths, i.e. 22.2°.

P-11: Cycle Pump With Compressor

To increase pump life and conserve electricity the pump can be programmed to cycle on and off with the compressor. The pump can also be programmed to operate continuously whenever the system is on. To program the pump for continuous operation, set P-11 to "con".

P-12: Reverse Automatic Fan Speeds During Heating

The automatic fan speeds can be reversed during the Heat Mode to improve heat output in cooler climates. The fan speed is decreased as the temperature spread increases. The fan will speed up as the set point is approached. Lowering the fan speed when the cabin is cold increases head pressure and raises the supply air temperature. Increasing the fan speed as the set point is approached also reduces unnecessary high pressure faults. The fan switches to low speed when the set point is satisfied and the compressor cycles off. The fan can be programmed to operate the same as in cooling by programming P-12 "nor" which represents normal fan operation during reverse cycle heating.

P-13: Reverse Cycle or Electric Heat

Units not equipped with reverse cycle heat may have electric heater added. Program parameter to "ELE" for the electric heat option.

NOTE: For Elite software revision A13 and older, when this parameter is programmed for electric heat, only the electric heat relay located towards the middle of the Passport I/O circuit board is energized during a heating cycle (see Sample Wiring Diagram at the back of this manual). For Elite software revision A15 and newer, when programmed for electric heat, both the electric heater relay and the valve relay are energized. This change was made to support the future elimination of the electric heater relay. Therefore, Passport I/O circuit boards that do not have electric heater relays will require an Elite display with software revision A15 or newer to properly energize the valve relay. Also, since the valve relay output can only support a maximum of 10 amps of resistive load, when installing an optional electric heater that exceeds this load, it will be necessary to also install an additional contactor that is rated to handle the full load of the electric heater. Please consult with Dometic Customer Service or with an authorized service technician for assistance.

P-14: Fan Motor Selection

IMPORTANT NOTE TO END USER:

Standard units have a Shaded Pole (SP) fan motor; the factory default parameter "SP" is correct for standard units. However, 24,000 BTU/Hr (24K) models and units with High Velocity (HV) blowers have Split Capacitor (SC) fan motors. **This program must be changed if you**



have a 24K or an HV unit. A 24K unit is identifiable by the "24" in the model number (i.e., VCD24K). A High Velocity unit does not have a blower motor overhang, the motor is inside the blower, and there is an "HV" in the model number. **If your air conditioner is one of these two models then you must change parameter P-14 to "SC" prior to operating the equipment.** Save this change as a new default by simultaneously pressing and releasing the Up and Down Buttons prior to exiting the program mode. Make note of new default in the Programmable Parameters table.

P-15: Reset Memorized Defaults

The default programming parameters can be reset by entering the Program Mode and selecting "rSt". This restores the programmable parameters to the default values. The default parameters listed in the Programmable Parameters table may be altered by the installing dealer or end user. Once new defaults are entered and memorized, the factory defaults will be over written. The original factory program parameters as listed in the Programmable Parameters table may be restored manually.

P-18: Air Filter Cleaning/Replacement Timer Setting

(available only in software revision A15 and newer)

The Elite can be programmed to display a reminder to clean or replace the evaporator air filter on a regular basis. This is especially beneficial when using Dometic's Breathe Easy® Micro-Particle and Anti-Allergenic Air Filters. By default, this timer is disabled (P-18=0). The allowed settings are 10-250 in multiples of 10, which correspond to 100-2500 hours.

NOTE: How often the air filter must be checked will depend on the air quality. Dometic recommends that you check the air filter at least every 500 hours of operation.

Once set, the timer keeps track of the total amount of run hours that the fan accumulates (see P-19). Once the timer setting is reached, "FIL" will briefly flash on the LED display every 10 seconds until it is cleared. The room temperature will continue to be displayed and the normal operation of the system will not be affected. The "FIL" reminder can only be cleared and the timer reset via programmable parameter P-19. See below for instructions.

P-19: Filter Cleaning/Replacement Timer Value & Reset

(available only in software revision A15 and newer)

This parameter displays the current elapsed time (in hours/10) since the timer was started or reset. For example, if the value of P-19 is "30", then somewhere between 300-399 hours have elapsed since the timer was started or reset. Once the value of P-19 reaches the value set in P-18 (explained above), "FIL" will flash on the LED display every 10 seconds until it is cleared. To clear the "FIL" reminder, press either the Up or Down button while viewing the P-19 parameter. This will reset P-19 to 0 and restart the timer.

Why Memorize New Defaults?

Once the desired programming changes have been made and the system tests satisfactorily, your work can be saved as the new defaults. Your new defaults are initiated by simultaneously pressing and releasing the Up and Down Buttons prior to exiting the Program Mode.

Software Identification

The software version of the control is identified for one second prior to the exit from the Program Mode. The software identification number, i.e. ("A10") will appear in the display for one second, then the control will return to the Off Mode.

Should there be any reason to contact Dometic Corporation about the system or programming the Elite, be sure to have the software identification number and serial number of the system available.

2.08 Failsafe, Fault Handling Codes, and Reminders

When a fault is detected Elite will display one of the following Mnemonic fault codes:

"HPF"indicates high Freon pressure.*

"LPF"Indicates low Freon pressure.*

"ASF"Indicates failed air sensor.

"PLF"Indicates the seawater FLOW has failed.

"LAC:Indicates the AC input voltage is less than 95VAC/195VAC

"FIL"Indicates that the air filter requires cleaning or replacement.

* NOTE:

- "HPF" is not indicated and does not cause lockout in Heat Mode.
- "LPF" has a ten minute shut down delay.

Equipment Operation

Failsafe Level 0

Only "ASF" detected and displayed. The control will shut down and will not restart until the fault is repaired. Once repaired the control will restart after a two minute delay.

Failsafe Level 1

All actions in level 0 plus all other faults detected but not indicated. The system shuts down for two minutes or until the fault is cleared whatever is longer. The system will restart if the fault is cleared.

Failsafe Level 2

All actions same as level 0 and 1. Faults are indicated. The system shuts down for two minutes or until the fault is cleared whatever is longer.

Failsafe Level 3

All actions the same as level 0, 1 and 2. The system shuts down for 2 minutes or until the fault is cleared whatever is longer. The system will lockout after four consecutive "HPF", "LPF" or "PLF" faults. Press the Power Button once to Off Mode, pressing it again to the On Mode clears the lockout.

2.09 Quick Start Operations Checklist

1. Make sure the A/C seacock is open. The handle should be in line with the seacock.
2. Activate the A/C breaker at the ship's distribution panel.
3. Turn the system on at the control pad.
4. Check for a steady stream of water at the air conditioning hull through hull fitting.
5. Refer to the troubleshooting guide should the unit not be operating properly..

Note: Do not turn the unit off and immediately turn it back on. Allow at least 30 seconds for refrigerant pressure equalization.



CARBON MONOXIDE DETECTORS

Carbon Monoxide known as CO is indeed the silent killer. It is a by-product of combustion. CO is invisible, tasteless, odorless and is produced by all internal combustion engines, heating and cooking appliances.

The most common forms of CO on board vessels are the engines, generator and if applicable, propane heating and cooking devices.

Never operate these devices when people are sleeping. A slight amount of CO in the human body over several hours causes headaches, nausea and symptoms close to food poisoning, motion sickness or flu. High concentrations can be fatal within minutes.

HOW THE SYSTEM WORKS

The CO detector uses a mini computer to measure and accumulate CO levels. It uses the principle of “time - weighted averaging.” The detector monitors CO concentrations, temperature, humidity and time to calculate COHb levels. To explain COHb, our bodies prefer to absorb CO to oxygen and COHb is the absorbed ratio stated in a percent.

If the detector senses high levels of CO the alarm will sound in a few minutes. If lower levels are sensed, the detector will accumulate the data and sound an alarm when the appropriate level is reached. *Read and understand the CO owner’s manual in the information pouch.*

To turn the CO detector system on:

1. Notice the CO breaker on the 12 volt main DC panel. The system should be always left on. The CO circuitry works to its best performance when continually activated plus it accords advanced warning when entering an area high in CO.

2. When power is applied to the detector, the power indicator (top) will flash on and off, followed by the (red) lower alarm indicator flashing off and on as part of a 8-14 minute warm-up period. The green (top) power indicator will indicate a solid green when the unit has reached correct operating temperature.

CO DETECTOR



3. The test cycle should be activated frequently. Simply press the button. When it is released, the (top) power indicator will flash off and the lower indicator light will flash. Then, the lower indicator will flash off and the upper indicator light will come back on.

The top indicator light being on solid green indicates

normal operation. Refer to the CO detectors owner’s manual for an explanation of the test cycle indicators.

4. When an alarm sounds take action immediately. The danger alarm indicator flashes red and the horn beeps 4 times, pauses and repeats the cycle. This indicates a rate of 10% COHb has been reached.

- a. Operate reset/silence button.
- b. Call your emergency services (911)
- c. Immediately move to fresh air. Do not re-enter the vessel. until emergency personnel have arrived, aired the vessel out and the alarm is in a normal condition.
- d. After following steps a-c and your alarm reactivates within a 24-hour period call a qualified technician to inspect the vessel. Note that the CO detector will clear when the CO concentration has dropped below 70 ppm.

Note: When the ship’s batteries are disconnected at the battery terminals, the CO detectors will not operate.

Equipment Operation

WATER/WASTE SYSTEM



DISPLAY MONITOR SHOWN W/O OVERBOARD DISCHARGE. PUMP-OUT FEATURES SHOWN BY LINES.

To read either the fresh water or waste monitor panel the breaker on the main DC panel must be activated.

The fresh water monitor displays the amount of potable water in the system. There are sensors located in the tank itself that send a signal to the display when activated. Press the top portion of the toggle switch and read the gauge display.

The waste portion of the display shows the amount of waste water in the holding tank. Press the bottom portion of the toggle switch for determining the waste tank level. This portion of the system needs to be monitored periodically to prevent the tank from being overfilled which could cause equipment damage and/or a possible leak in the vessel.

If the waste system is determined to be full it can be emptied by connecting a marina pump-out hose to the waste fitting located on the port deck. The pump out device will evacuate all the waste much like a vacuum cleaner operates.

An alternative method **which can be used in International waters only** is to pump the waste overboard via a seacock. Vessels featuring a macerator show a key switch versus the monitor panel plug and a system on light. **Make sure the waste seacock is open before energizing the macerator through the key switch.**

To operate the overboard discharge pump turn the macerator breaker on at the main panel. Then turn the monitor panel key switch to the on position. The system light will show red. While holding the switch, energize the macerator switch to start the macerator. Continue until all waste is pumped overboard. **Remove the key from the monitor panel switch when finished.** *Be sure to turn the seacock off and use a new tie wrap to lock seacock handle.*

OVERBOARD DISCHARGE PUMP



The overboard discharge pump empties the holding tank.

When the key on the monitor panel is energized to the full on position, and the macerator momentary on

button is pushed in and held down the macerator engages to pump the tank waste overboard. **Make sure it is legal to pump the waste overboard in your particular geographical location before you start the operation.** Also, open the waste seacock. See the information under the fresh water and waste monitor. The pump can be disconnected from the 2 unions that hold it in line for maintenance purposes.

Do not flush paper or feminine hygiene products into the waste system. Keep toilet tissue usage to a minimum. Do not use bleach or toilet cleaners in the waste system. Use only maine approved products. Rinse and flush the holding tank after each pump out. This will dilute any residual waste, and help prevent blockage and reduce odors. It is a good idea to carry extra fuses on board for the pump along with spare parts. Refer to the cosmetic care and maintenance chapter in this manual and the manufacturer's owner's manual for further information.



TYPICAL SHOWER SUMP PUMP

The gray water system is primarily designed to handle the used sink, shower and air conditioning pan water. The system passes used water through the shower sump pump and eventually is discharged into a tank. The different hoses routed to and from a typical shower pump are indicated below.

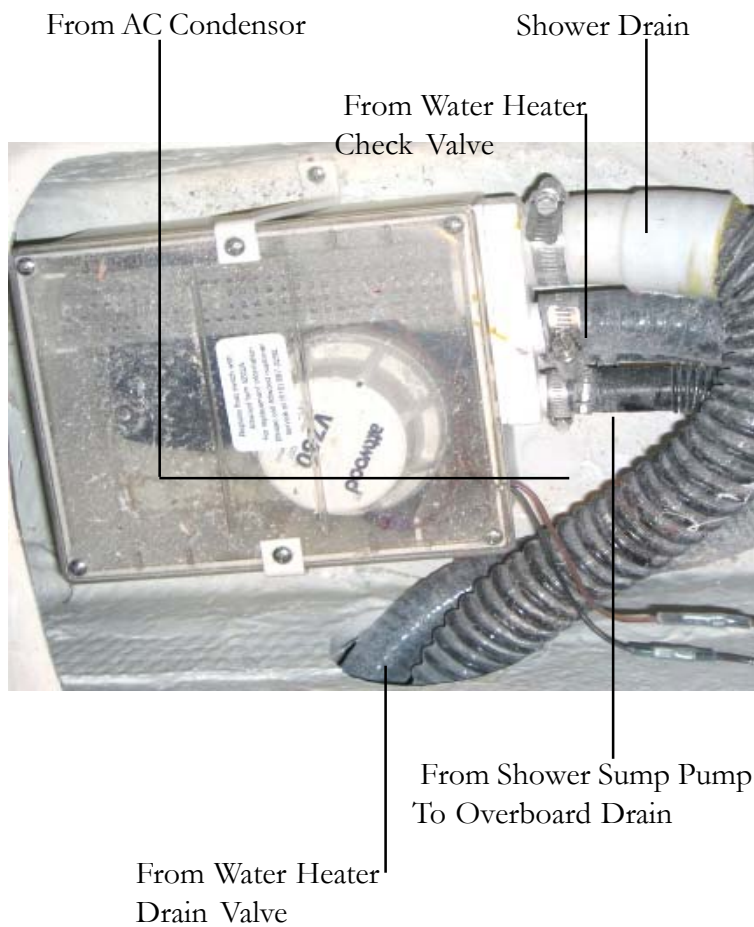

MARINE SANITATION REGULATIONS

All boats with fixed toilets used in U.S waters and various waters worldwide are required to be equipped with an operable marine sanitation device (MSD). Our electric marine toilet systems use holding tanks and are defined as Type III by the U.S. Coast Guard.

Type III systems are designed to permit operation of the toilet without the direct discharge of untreated waste after every flush. This means the system can be used when the vessel is near shellfish, beaches or swimmers.

Type III systems can be discharged at marina dockside pump-out stations or, if in coastal waters, a minimum of 3 miles offshore. **Overboard discharge capability must be secured while within the three-mile limit.** The overboard discharge pump is activated by a keyed switch located at the monitor panel. **This key must be removed at all times except when discharge pump is operating.**

WASTE SYSTEM FILTER

An in-line waste filter is installed in the vent hose between the waste tank and the waste vent thru-hull fitting. It acts as a waste system odor absorption device to keep waste tank odors under control. It is recommended that the filter be changed yearly. Call your authorized Regal yacht dealer for more information. The filter is located in the bilge.



Equipment Operation

TYPICAL ELECTRIC TOILET

Your vessel features an electric toilet, holding tank and in-line filtering components. The system can be operated using water from the on board water tank or from dockside water resources. See the illustration for typical components.

To operate make sure the breaker is activated at the ship's main panel. If using dockside water turn on the marina spigot.



The head wall control switch is used to add water to the bowl and to flush the toilet. Select cycle information is noted below. For further information refer to the toilet vendor information located in the information pouch.

1. To add water (estimated 17 ounces per cycle) to the bowl press the add water button momentarily and release. The system prevents overfilling the bowl.
2. To flush the bowl press the flush button momentarily and release. The attached bowl motor will macerate the waste and flush it. The cycle ends with a small amount of water being added to the bowl to help prevent odors. This completes the minimal water usage flush cycle.

Wall Control Panel Blue Backlighting Description:

- A. The holding tank icon in the lower right hand corner of the control panel is not lighted. Toilet system is off or not receiving power.
- B. The holding tank icon is normally green. This means the holding tank is less than half full.
- C. The holding tank icon is red. The holding tank is full or near full with the flush lockout (prevents flush operation when holding tank is full) activated.
- D. Tank icon flashes.
- E. Sleep mode (non-use for 8 hours) causes the lights to go out. Pushing the fill or flush button momentarily will return the lighting cycle.

Single Flush Override of Flush Lockout

1. If the holding tank is full the flush lockout cycle will not allow the bowl to be flushed and the flush button will be lighted red.
2. For emergency use only the flush button can be held for 8 seconds and a flush will occur. This can be accomplished because the full sensor connected to the holding tank is usually placed a bit below the actual full capacity of the tank. Flushing more than 5 times using the override may force waste into the plumbing system. **Regal is not responsible for damage to equipment, or injury due to overflow of waste due to the flush lockout being overridden.** Again, refer



TYPICAL TOILET SYSTEM

- 1. TOILET BOWL
- 2. SOLENOID VALVE
- 3. FRESH WATER PRESSURE PUMP
- 4. SYSTEM VENT
- 5. HOLDING TANK
- 6. FRESH WATER TANK (SYSTEM CAN BE RUN FROM DOCKSIDE WATER SUPPLY)

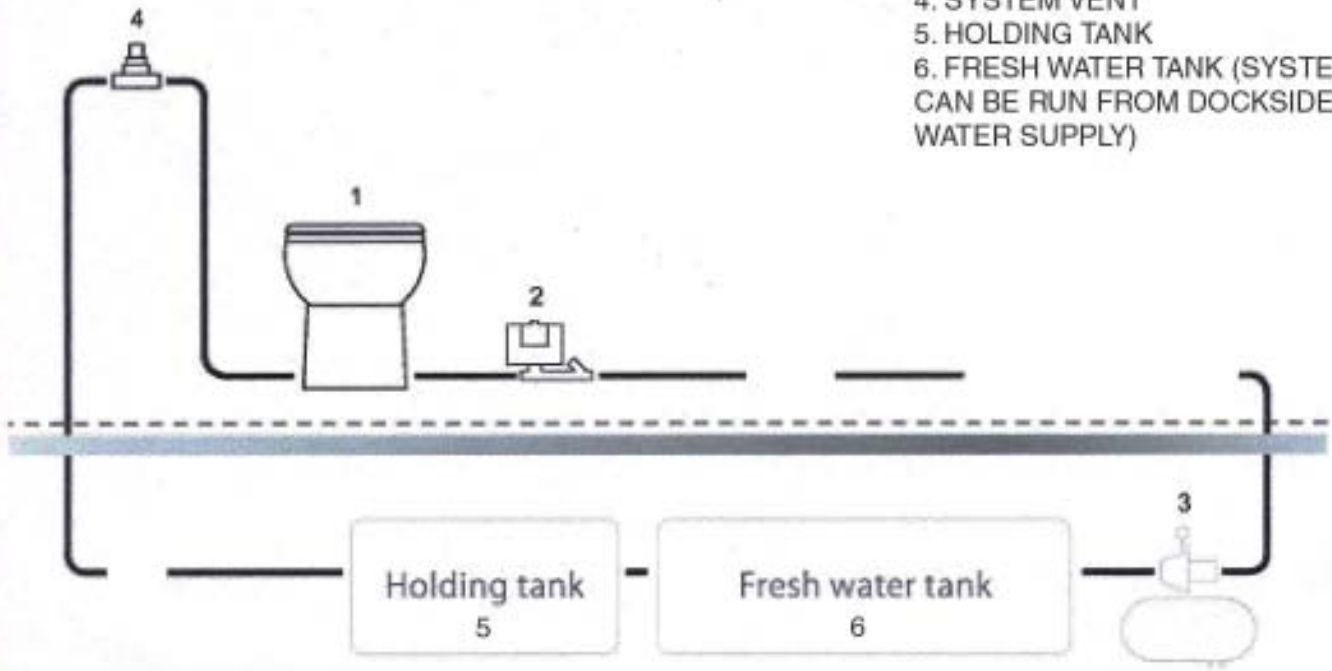

Equipment Operation

TYPICAL TOILET ELECTRIC CIRCUIT

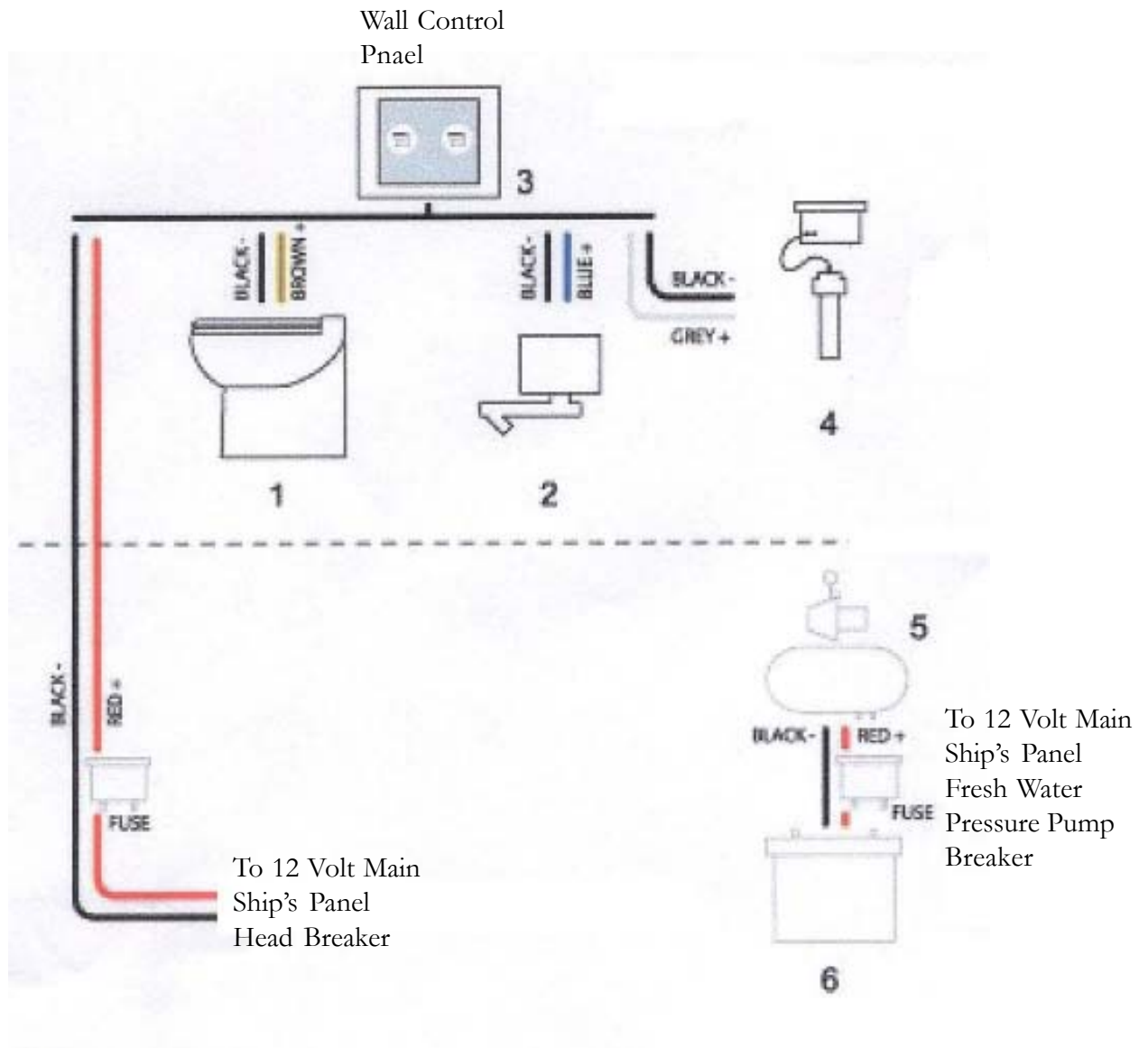

Components

1. Toilet Bowl
2. Solenoid Valve
3. Fresh Water Pressure Pump
4. System Vent
5. Holding Tank
6. Fresh Water Tank



FRESH WATER SYSTEM

Your vessel is equipped with a fresh water supply system. It consists of a water tank, deck fill vent, water monitor system, pressure water pump, distribution system, water filter, dockside water pressure regulator and water heater. The system holds fresh water until it is energized with the variable pressure pump or with the dockside water pressure regulator system. The system will supply water to the galley, head, cockpit and transom shower as needed.

The system is winterized from the factory utilizing a product called “freeze ban”. Completely drain the freeze ban before adding any water to the tank in order to minimize the taste of the Freezeban. Freezeban will not harm you but it does have a peculiar taste. The system requires little maintenance except occasional cleaning of the water filter and winterizing if in colder climates.

FRESH WATER TANK

The water system should be disinfected prior to use and at the beginning of each season. Your marina may have products designed specifically for this purpose. An alternative is to use common household bleach. The formula used by the U.S. Public Health Service is to multiply the gallon capacity of the system by 0.13 to get the ounces of common bleach to add to the system. Mix a solution of common bleach with a gallon of water and add to the water storage tank through the fill located on the port aft deck. Fill the tank with fresh water. All faucets should be turned on until a bleach odor is detected. The system will be sanitized in four hours at which time the system should be drained using the faucets and then refilled with fresh water. Flush system by draining the tank again. Fresh water can be added to the tank by using a hose. Make sure the dockside water supply is suitable for drinking.

TYPICAL OVERBOARD VENT

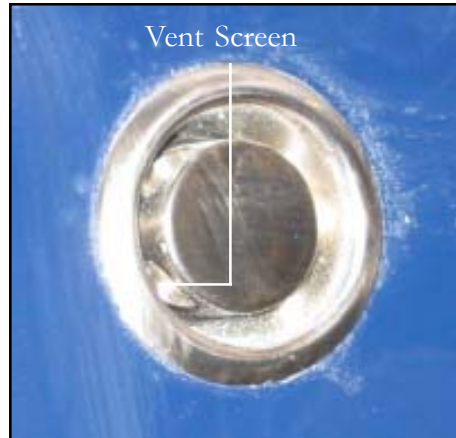

The overboard vent located on the deck is designed to relieve the air that is displaced by the water added to the water supply tank. As the tank nears full it is possible that water will be forced out of the vent. This should be considered normal. The screen on the vent should be occasionally inspected for insects or spider webs, etc. Blockage of this vent can cause the water tank to fill slowly or in extreme cases to blow water back out the fill tube as the water supply tank is being filled.

Equipment Operation

FRESH WATER PRESSURE PUMP

The fresh water pump is controlled by a breaker on the main DC control panel. Energizing the switch allows the pump to build the water pressure in the distribution lines to around 35 psi.

When the pump reaches this level it should automatically shut off. If the system drops below a certain pressure the variable speed pump will restart. If the pump cycles on and off with no water being used, a leak in the water system is likely. Periodically clean the water inlet filter and check the plumbing connectons for tightness. See the illustration below and the maintenance chapter for additional information.

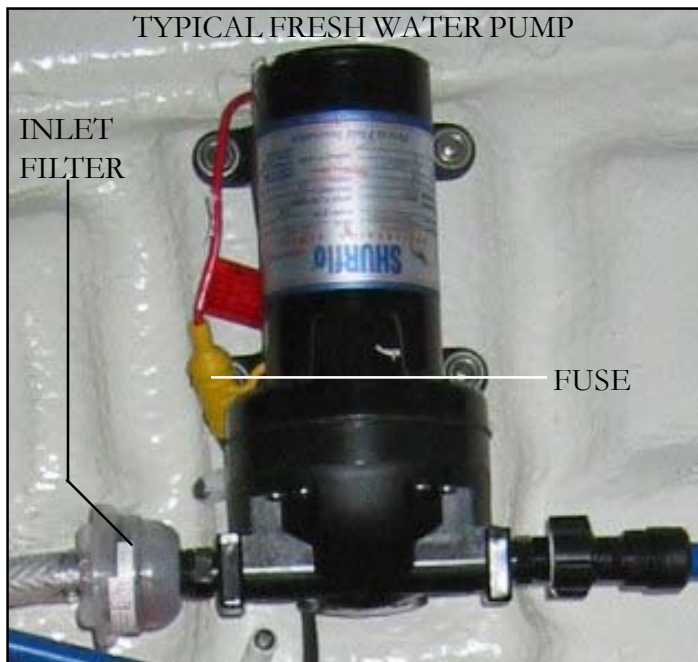

TRANSOM SHOWER



Your vessel may feature a hot/cold combo or cold transom shower wash down. Note that the faucet controls are marked red for hot and blue for cold. A sprayer with sufficient hose is located in the faucet center. This device is handy for rinsing off before entering the cockpit from the swim platform.

DOCKSIDE WATER INLET



The dockside water inlet is located on the transom. It allows a hose to be connected to the inlet pressure valve. The purpose of the regulator is to allow water pressures up to 35 psi's to enter the boat. This device uses dockside water and a valve in the system allows the on-board fresh water supply to be bypassed. It also eliminates excessive water pressure from bursting water lines and causing leaks in the boat's water system.



HOT WATER HEATER

The hot water heater features a 6 gallon capacity and has the ability to keep the water warm during cruising. This is accomplished by a set of hoses connected between the hot water tank and the circulating engine water pump. Engine coolant runs through a heat exchanger which keeps the tank water warm when the engines are running. To initially fill the hot water heater, ensure the boats fresh water tank is full. When the tank is full water will be ejected from the deck vent. At the DC side of the main ship's AC/DC panel, turn the fresh water pump to the "on" position. **Make sure the water heater is full by opening a hot water faucet until a steady stream flows out.** With the generator running or the shore power connected, switch on the hot water heater at the AC side of the ship's service panel. The heating element will now begin to heat the hot water tank.

Should the hot water heater reset button need resetting, turn off the hot water breaker at the AC side of the main control panel. Then remove the panel cover to expose the reset button. Press the red reset button. After refastening the access panel, flip on the hot water breaker to continue the systems operation.

Should the need arise there is a drain valve located in the rear of the heater. Make sure the water is cold before attempting to open the valve. The valve runs through the shower sump pump and then overboard. Never try to open the drain valve before turning off the AC breaker. The thermostat is non-adjustable on this unit. Contact a marine professional for further information.

A T&P valve protects the system from overheating. If the temperature is too hot, the valve will open.

CAUTION

TO AVOID POSSIBLE BODILY INJURY DUE TO ELECTRICAL SHOCK DO NOT TRY TO OPEN UP THE HOT WATER TANK COMPONENTS WHILE THE AC POWER IS ACTIVATED. TURN HOT WATER BREAKER OFF AT THE MAIN AC PANEL.

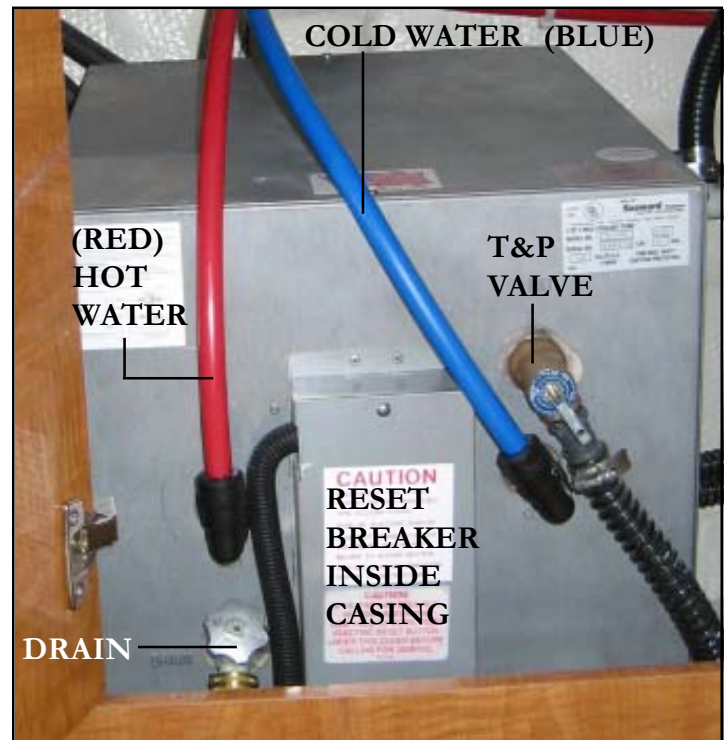

CAUTION

TO AVOID POSSIBLE BODILY INJURY DUE TO HOT WATER, BE SURE TO CHECK THE WATER TEMPERATURE BEFORE USING IT. THIS IS ESPECIALLY TRUE AFTER CRUISING WHEN THE WATER HAS BEEN TRAVELING THROUGH THE HEAT EXCHANGER HOSES.

NOTICE

TO AVOID POSSIBLE EQUIPMENT DAMAGE, DO NOT TURN ON THE HOT WATER BREAKER WITHOUT THE WATER HEATER BEING FULL. DAMAGE TO THE HEATING ELEMENT WILL OCCUR.

Equipment Operation



CAUTION

TO AVOID POSSIBLE BODILY INJURY DUE TO A BUILD-UP OF HYDROGEN GAS (USUALLY FOUND IN HOT WATER HEATERS THAT HAVE NOT BEEN USED FOR 2 WEEKS OR MORE), IT IS RECOMMENDED THAT THE GALLEY HOT WATER FAUCET BE OPENED BEFORE USING ANY EQUIPMENT CONNECTED TO THE HOT WATER SYSTEM. THIS PROCEDURE WILL PURGE THE SYSTEM OF ANY HYDROGEN GAS. DO NOT SMOKE OR USE AN OPEN FLAME NEAR THE FAUCET WHILE IT IS IN THE OPEN POSITION.

NOTICE

TO AVOID POSSIBLE FLOODING OR EQUIPMENT DAMAGE, TURN OFF THE DOCKSIDE WATER SUPPLY WHEN THE VESSEL IS UNATTENDED.

TYPICAL GALVANIC ISOLATOR MONITOR SYSTEM

One of the most important elements in using shore power aboard a vessel is that while it is plugged into shore power the bonding system needs to be electrically connected to earth.

Missing this earth connection allows the bonding system to be potentially “hot”. If this occurs, the chance for electrocution to anyone in the water or boarding the boat dramatically increases.

Your vessel utilizes a galvanic isolator. Its purpose is to allow the separation of the bonding system from the dock and other boats at low voltages (less than 1.4 volts) but to keep it connected to the shore ground at high voltage potentials. Remember, the zinc anodes installed on the vessel protect your boat only. For this reason the name “zinc saver” is a term sometimes used to describe the galvanic isolator.



This type of galvanic isolator connects to your electrical/bonding system for less than 20 seconds during a day. This limits the negative effects on the ship’s bonding system. The monitor performs various tests when connected to shore power or activated by the push to test button or every 6 hours after that. After it does a “self-test” then it tests the ground wire continuity and the galvanic isolator and shows the results on the monitor head. During the self test the LED’s will light on the panel. It is considered a dealer serviceable item.



MONITOR PANEL



To use the monitor in the automatic mode, turn the main AC panel breaker and the transom shore power breaker to the off position. Turn the dockside breaker to the off position.

Connect both ends of both shore power cords. Turn on the

dockside breaker. The monitor will activate itself. It will perform the self-test. Then it will display the ground wire condition and the galvanic isolator in about 20 seconds. This test will be completed every 6 hours.

*If the “fail” icon lights up on either the ground wire or galvanic isolator displays an ungrounded bonding system exists and **should be considered dangerous**.* Disconnect the shore power cord after turning the dockside breaker off and call a marine electrical technician to troubleshoot and repair the situation.

To use the monitor in the manual mode, press the “test”

button on the display panel. A sequential set of LED’s will light up indicating the status of the ground wire and galvanic isolator as either pass or fail.

*If the “fail” icon lights up on either the ground wire or galvanic isolator displays an ungrounded bonding system exists and **should be considered dangerous**.* Disconnect the shore power cords after turning the dockside breaker off and call a professional electrical technician to troubleshoot and repair the situation.

Note: The monitor will display both shore power 1 and 2 systems.

MONITOR LED DISPLAY ANALYSIS

Ground Wire “Normal”- The shore power ground wire has been tested and is connected to neutral through the shore side ground circuit.

Ground wire “Fail”- The shore power cable ground wire has been tested and is not connected to neutral. **This is a potential life threatening condition.** Disconnect the shore power until the “open” wire is found and repaired. Call a marine electrical technician to repair the fault.

Ground wire “Fail”- The shore power cable ground wire has been tested and is not connected to neutral. **This is a potential life threatening condition.** Disconnect the shore power until the “open” wire is found and repaired. Call a marine electrical technician to repair the fault.

Galvanic Isolator “Normal”- The galvanic isolator has been tested and found to be operating properly.

Galvanic Isolator “Fail”- The galvanic isolator has been tested and is defective. This is an unsafe condition and the shore power should be disconnected and the isolator replaced. Contact your closest Regal dealer for more information.

Equipment Operation

ENTERTAINMENT

TYPICAL STEREO

The standard stereo system features a head unit that opens to play different iPod versions. Adapters are available for individual iPods. It is rated at a maximum of 70 W x 4. It is a 12 volt DC based system with a negative ground. Basic information is listed below. Be sure to read the vendor supplied manual describing the overall functions of the unit. Also, be sure to register the product on-line at: www.fusionelectronics.com.

CONTROL PANEL LAYOUT



BUTTON DESCRIPTION



Menu



Power



Tuner
source



Auxiliary



Rewind



Play/Pause



Forward



Mute



Clock



Brightness

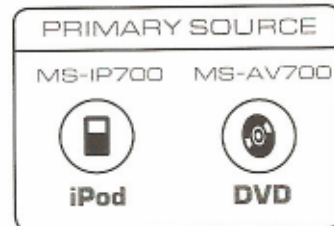



USING IPOD

This unit has been tested with compatible authentic iPod models under normal operating conditions. free from any pre-existing defects in either the unit or the iPod. No responsibility can be taken for the use of the unit other than under normally expected operating conditions in conjunction with fully functional and undamaged iPod units which have been manufactured and authorized by Apple Inc.

USB FLASH DRIVES

Drive format: All USB flash drives used with this unit must be formulated to either FAT32 or NTFS format. These are the most commonly used format for USB flash drives.

Audio track format: Audio tracks store on USB flash drive must be in MP3 format to play on this unit.

Care and Maintenance

Clean any salt water and/or salt residue from the stereo with a damp cloth soaked in fresh water.

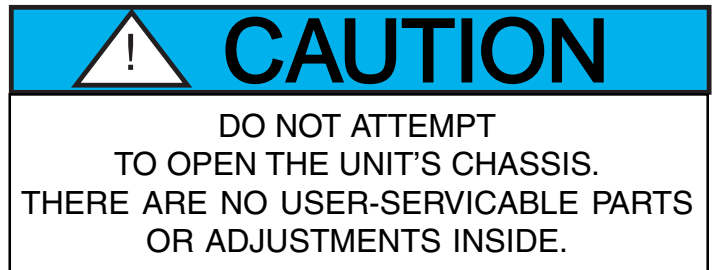



Equipment Operation

ROTARY ENCODER AND MENU KEY

Although the controls of the 700 Series are designed to be intuitive to use, we recommend that you familiarize yourself with the operation of the Encoder and Menu key before using the unit.



ROTARY ENCODER OPERATION

The Encoder can be used in three ways to control the operation of the 700 Series:

1		Rotary Encoder turn
2		Encoder press
3		Encoder press and hold down for at least one second

MENU KEY OPERATION

You can use the Menu key to open or to exit from menus:

	Menu key	Press the Menu key to open a menu.
	Menu exit	<p>In an open menu you can use the Menu key at any time to save changes and exit:</p> <ul style="list-style-type: none">• Press the Menu to exit from the current menu level or control screen.• Press and hold down the Menu key to exit from the menu completely. Or press any other key. <p>Time out feature: After 10 seconds of inactivity, the menu exits and any changes are saved automatically.</p>



USING THE ROTARY ENCODER AND MENU KEY

USING THE ROTARY ENCODER AND MENU KEY

You can use the Rotary Encoder and Menu key to adjust levels, access menus and open control screens.

Adjusting levels

Use the Encoder and Menu key to adjust levels on the 700 Series.
For example, to adjust the volume level:

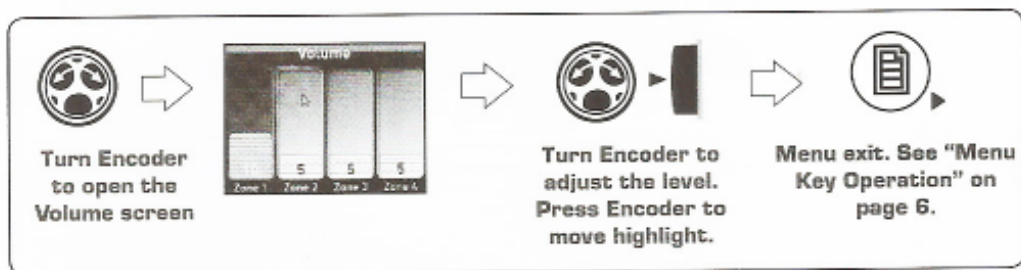

Accessing Menus

Use the Menu key and Encoder to access menus to change settings.
For example, to access the Settings menu:

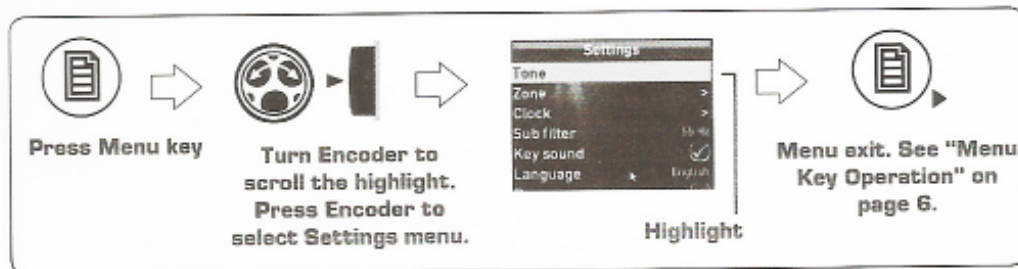

Equipment Operation

POWER UP FROM MAIN SHIP'S PANEL

To power up the stereo head unit, energize the stereo breaker located on the ship's main service panel. The stereo memory circuit will preserve all pre-selected stereo inputs.

Opening Control Screens

Use the Encoder to open the Sub Level and Tone control screens to adjust levels:

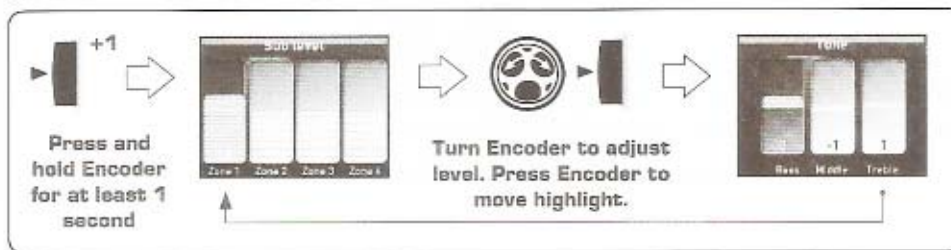

GETTING STARTED

POWERING THE UNIT ON OR OFF

When you power on the 700 Series it will automatically start playing music from the most recently selected input source.

To power the unit on or off.

 Power	<ul style="list-style-type: none">• Momentarily press the Power key to power on the unit. As the unit starts up, a splash screen is displayed for several seconds, followed by the current input source.• When the unit is on, momentarily press the Power key to power off the unit.
---	--

INPUT SOURCE SCREENS

The 700 Series supports a wide range of input source types, depending on model:

- **MS-IP700.** AM/FM/VHF/SiriusXM; USB and iPod/iPhone via internal dock; auxiliary



TELEVISION SYSTEM OVERVIEW

Antenna



The antenna switch includes two buttons which choose the proper antenna for dockside and at sea operation.

1. At dockside, the *shore* antenna switch should be activated. For this switch to work the TV cable needs to be plugged into the vessel's transom cable inlet located inside the shore power locker and run to the dockside connection. With the shore antenna pressed the on board television uses the local signal.
2. At sea, the *ship's* antenna switch is activated which inputs a signal from the exterior mounted antenna. Note that antenna interference may develop if vessel is stored in boat house with metal roof.
3. To deactivate either switch, simply depress the switch completely and release.

TELEVISION BASICS

The LCD television set on board your vessel is powered by 12 volts DC. The television speakers can be used in conjunction with the stereo to hear an audio signal by using the television auxiliary input.

For detailed data on the on board television refer to the manufacturer's manual located in the owner's pouch.

LCD MONITOR OPERATION

The flat screen salon television is connected to various audio and video connections as added features. The unit has been pre-programmed at the factory.

The unit features a non-glare screen and remote control. to operate the television flat screen monitor (to be called monitor here).

CAUTION

**RISK OF ELECTRICAL SHOCK!
DO NOT REMOVE BACK COVER
OF TELEVISION MONITOR.
NO USER-SERVICEABLE PARTS INSIDE.
REFER SERVICING
TO QUALIFIED PERSONNEL ONLY.**

When the monitor is used in a low temperature space the room the picture may leave trails or appear slightly delayed. This is normal and the monitor will recover once a normal temperature is reached. Do not leave the unit on in a hot or cold location. Also, never leave the monitor in a direct sunlight location or near a heater, as this may cause the cabinet to deform and the LCD panel to malfunction.

Equipment Operation

TYPICAL MONITOR CONTROL PANEL REMOTE CONTROL BATTERIES

Refer to the antenna switch information on the opposite page for proper connection depending where the vessel is moored.

A DVD player is an integral part of the television system and is integrated in the aft end of the set. Video camcorder, digital camera, iPod and home video games can also be used with the system through the various input and output jacks. The following information is an introduction only to the monitor. **Refer to the appropriate illustration and/or the television owner's manual for further in-depth information on the monitor/television system.**

To energize the system follow these recommendations:

1. For docked vessels, make sure the shore power breaker is energized and the reverse polarity light is not lit.
2. Check for line voltage at the ship's AC panel. We recommend turning on the battery charger breaker to keep the batteries up while the vessel is docked.
3. Check the antenna switch for the shore position.
4. For vessels at sea activate the antenna ship's position.

TYPICAL REMOTE CONTROL

A remote control is provided to operate the multi-functions of the television monitor system.

A few recommendations on the remote control:

1. Do not expose the remote control to shock. Do not expose the control to liquid, or place the control in high humidity.
2. Do not expose the remote control to direct sunlight. The heat could deform the control itself.
3. The remote control eye may not work properly if it is under direct sunlight or strong lighting. If these conditions exist, change the angle of the monitor or the lighting or move the control closer to the monitor.

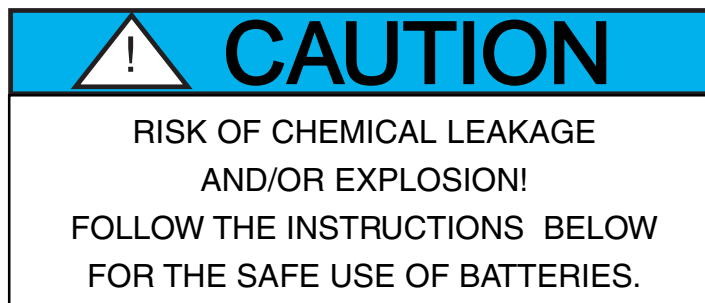

1. Be sure to follow the correct polarity of the batteries is observed when loading them into the remote control. The remote control provide directions for correct installation. If unsure refer to the monitor owner's manual.
2. Since different types of batteries possess their own characteristics do not mix different types of batteries.
3. Do not mix new and old batteries. Old batteries have the potential to leak chemicals and the can weaken the power of the new batteries when mixed together.
4. When batteries become weak remove them from the remote to help stop any chemical leakage that may occur.
5. Leaking battery chemicals can cause a skin rash. Wipe with a cloth.
6. If the vessel is not expected to be used for an extended period of time remove the batteries from the remote control.
7. If the remote control should show signs of chemical leaks or corrosion wipe any chemical off with a dry cloth and use a emery board to clean any corroded terminals. Purge any loose debris out of the control before reinstalling batteries.



TYPICAL REFRIGERATOR

The cabin refrigerator operates on 12 volts. It is controlled by a breaker located on the main DC control panel. The refrigerator is fitted with a manually operated, infinitely-variable thermostat. Turn the knob clockwise to reduce the temperature and counterclockwise to increase the temperature. It may take a little fine tuning to reach the particular setting you desire.



When the ice layer approaches 1/8" the unit needs to be defrosted. Turn the thermostat off. Transfer all items from the refrigerator to keep them cold while the unit is defrosting. Do not use sharp or metal objects to remove the ice. When the defrosting cycle is complete, empty the drip pan under the freezer compartment. Clean the inside of any food residues with a damp cloth and a mild cleaner. Rinse and let dry.

Turn the thermostat back on and restock the unit with the cold storage items you removed. This will help the unit cool down much faster.

When left for extended periods of time, be sure to leave the door partially open for ventilation purposes.

For more detailed information, refer to the manufacturer's manual in the owner's pouch.

To turn off the galley refrigerator simply deactivate the refrigerator breaker switch on the DC main ship's panel or turn the knob inside the refrigerator to "off".

TYPICAL MICROWAVE



Since this unit operates the same as a household microwave, specific instructions can be found by referring to the manual located in the owner's information pouch.

HATCHES/PORTLIGHTS



The hatch features removable screen/sunshades. To open a hatch, turn the hold down adjuster counterclockwise to unlock it. This permits the hatch to open when the three latches are turned to clear the hatch.

Press the lock to the open position. Push the hatch to the desired opening angle and then turn the hold down adjuster clockwise to secure hatch. To close the hatch, reverse the procedure. Make sure the latches are completely closed to prevent any possible leaks. Portlights open and close using the same procedure.

Equipment Operation

TYPICAL STOVE

 **CAUTION**

AVOID POSSIBLE BODILY INJURY OR PROPERTY DAMAGE!
READ AND UNDERSTAND THE STOVE MANUAL BEFORE ATTEMPTING TO USE THE STOVE. THE COOK TOP LIKE ALL APPLIANCES HAS THE POTENTIAL TO CREATE SAFETY PROBLEMS OR PERSONAL INJURY IF USED CARELESSLY OR IMPROPERLY.

 **WARNING**

AVOID SERIOUS INJURY OR DEATH!
DO NOT ALLOW SMALL CHILDREN NEAR THE COOK TOP UNATTENDED!

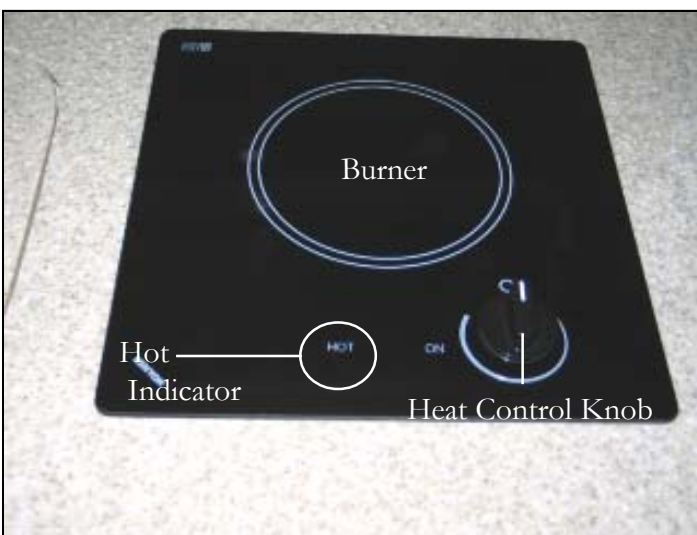

Your stove features the best possible cooking surface, easy maintenance, and the latest design. The cooktop areas of your stove are identified by permanent patterns etched in the top itself.

Your existing utensils (pots & pans) should work with a ceramic glass burner. Preferably your utensils should have a slightly concave or flat bottom. Glass cookware may be used but metal utensils conduct heat the best. Use cookware that fits the element size. This will assist in maximum heating efficiency and ensure the shortest boiling times. Check to make sure the cook top panel and the utensil bottom is dry before using. This will help prevent scratches and stains.

The cook top controls are called infinite controls. These controls start at low and increase heat output as the control is turned clockwise. Normally there is a “hot” indicator light. When lit, a portion of the cooktop is still too hot to touch. Place only cooking pots and pans on the top while the “hot” light is lit.

Your state of the art stove features ceramic glass top elements. Below the glass top is a series of heating coils. The design of these burners directs the heat up through the ceramic glass providing an efficient cooking surface. Outside the immediate burner area the ceramic glass is at a much cooler temperature even when cooking at high temperatures.

There is a set of thermal limiters in the burner that keeps the element from overheating. These limiters will reduce the wattage to the element if a pan boils over if an improper utensil is used or if no utensil is used at all.

Before using the stove for the first time use a recommended type cleaner such as (Cerama-Brite Cook Top Cleaner) on the cook top. The process will leave the stove surface with a clean, shiny, and most importantly a protective surface.

Always remove food spills, grease splatters and residues from utensils. You can buy a special scraper just for glass cook top use. Angle the blade at 45 degrees to remove cooking residue. This angle assists in preventing the blade from scratching the surface. Change the blade out as needed. Then use a paper towel to clean the surface or a clean soft cloth and a recommended cleaner. After using any cleaner wipe the cook top with a clean damp cloth to remove any cleaner residue build-up. Wipe dry.



Do not use a dish towel or sponge to wipe the cook top as they may leave a detergent film that can discolor the cook top surface when the unit is heated up.

Do not use abrasive or acid based cleaners on the cook top surface. Also refrain from using chemical cleaners such as ammonia, chlorine bleach, or chemical oven cleaners as they may discolor the surface. Avoid using plastic, metal or nylon scouring pads. They may scratch or melt onto the cook top.

Do not let any item that melts such as sugar, plastic or aluminum foil come into contact with the cook top when it is hot. Should such an accident happen immediately move the object to a cooler portion of the cook top surface with a razor scraper and remove it from the cook top as soon as possible.

Only use dry potholders as wet ones on a hot surface can produce steam and consequently burns. Never use a towel as a potholder.

Do not leave the cook top unattended with the burner set on high heat. A boilover may create smoke and or a fire. Turn pan handles inward to protect against accidental spillage.

Pot retention railings are available from Kenyon. Contact your Regal dealer or Kenyon for more information.

STOVE SAFETY INSTRUCTIONS

1. Do not use the stove to heat the cabin.
2. Do not touch the burners or surrounding cook top areas. These areas may be hot enough to cause serious burns.
3. Do not store items of interest to children anywhere above or below the immediate stove as children climbing on the stove to reach these items could be injured.
4. Do not wear loose fitting garments while using the cook top.
5. Keep the stove owner's manual in the pouch for reference purposes.

NOTICE

AVOID POSSIBLE INJURY AND EQUIPMENT DAMAGE. DO NOT ATTEMPT TO REPAIR OR REPLACE ANY PART OF YOUR GLASS TOP COOK TOP. IF THE UNIT NEEDS TO BE REMOVED FOR REPAIRS TURN OFF THE STOVE BREAKER AT THE SHIP'S MAIN SERVICE PANEL.

Equipment Operation

TYPICAL BERTH/SLEEPER SET-UP

The forward berth converts to a sleeper accommodating 2 adults. To set-up the berth follow these steps:

1. First locate the 3 stainless steel bars. Insert the bars in the mold cut-outs using pole length as a placement guide. See illustration 1.



2. The forward berth backrest cushions fill in to form the berth. The port and starboard backrests are held in place with a clip.

Grasp the starboard backrest cushion and with a quick motion pull up to release it from the retaining clip. Do the same with the port cushion. The starboard backrest cushion forms the starboard berth. The port backrest cushion forms the port berth. See illustration 2.

3. After all cushions are installed make sure they are seated properly before using the berth.



4. To disassemble the berth, remove each bar and store under floor.

5. Make sure each backrest cushion is stored in its original position. Do not force the clips as they may damage the vinyl. The clips should seat with light pressure only.



TYPICAL DINETTE TABLE

To set the dinette table up follow these steps:

1. Turn the table upside down. Loosen the adjustment knob on the table receiver. Insert the table leg inside the table receiver and tighten the adjustment knob until tight.

2. Insert the table assembly into the floor receiver. Push down to secure the table in place.

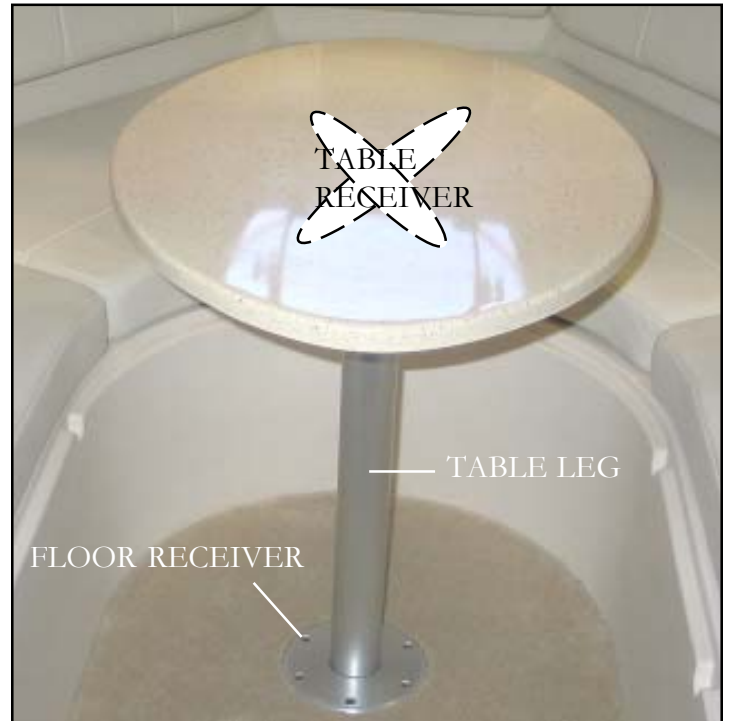

Equipment Operation

EXTERIOR EQUIPMENT

There are a variety of components found on the deck. **For the most in-depth information, refer to that particular equipment manufacturer's manual located in the owner's document pouch.**

Equipment or vendors may change during a boat's life cycle. *Portions of the components discussed here may or may not be on your vessel.* They may vary visually or in description. Regal retains the right to change vendors, equipment, specifications and other technical data at any time.

TYPICAL WINDLASS

If equipped, the windlass is used for anchoring. It features a chain and anchor. Be sure to familiarize yourself with the windlass owner's manual before attempting to operate it.

Keep all body parts and loose clothing clear of the chain and gypsy to avoid personal injury. The windlass must not be the only means of releasing the anchor. **Never use the windlass under power with the emergency handle inserted into the clutch nut or gypsy cap.**

To let out the anchor make sure the gypsy is locked and the safety lanyard is off the anchor chain. Use the dash switch to let the anchor out while backing down slightly in reverse.

The vessel engine is used in reverse slightly to break the anchor loose instead of the windlass. Once loose, press the dash switch to retrieve the anchor. As the anchor approaches the boat slow the process down so the bow is not damaged by the rising anchor. Maintain sufficient chain tension to control the vessel and prevent the bow from swinging. Before

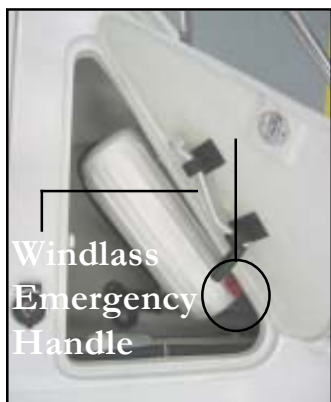

maintenance is performed remove the chain from the gypsy and rope from the drum. Periodically spray down the outer casting of the anchor windlass. Use only chain and spare parts as recommended by the manufacturer.

Note that the anchor features a safety lanyard that must be released for the anchor to be operated through the windlass controls. Reconnect lanyard after retrieving anchor.

To let out the anchor with the emergency handle, insert the handle in the gypsy. Unlock the gypsy just enough so the anchor will start to let out.

To retrieve the anchor, tighten the gypsy lock. Insert the handle into the other hexagon hole and crank the handle in a counterclockwise direction to bring the anchor up.

Be sure you use the engines to first break the anchor free from the bottom. Watch the anchor as it approaches the bow to avoid damage.

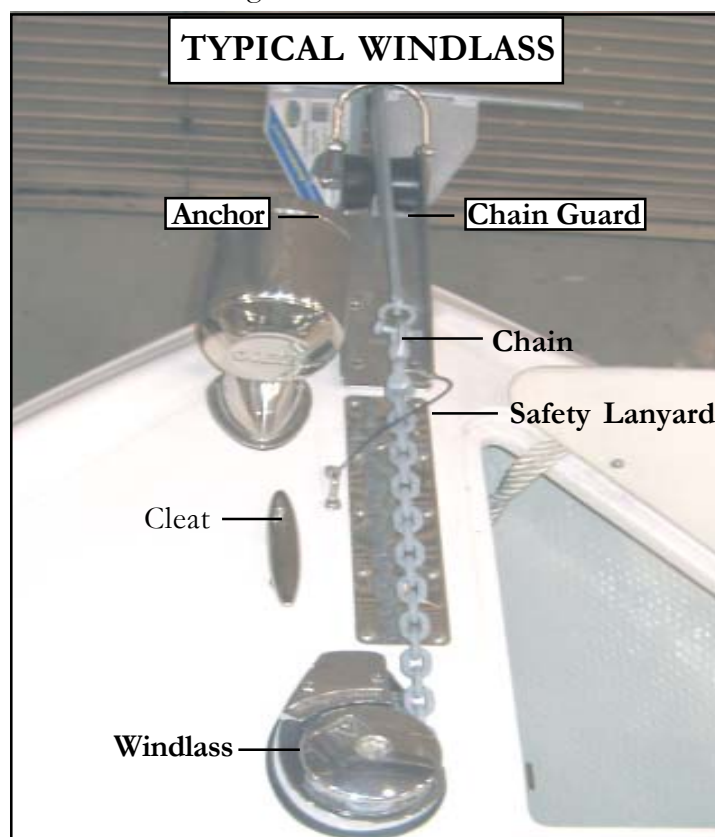



CHARTPLOTTER

If equipped the chartplotter is located at the helm. The following information is a quick reference regarding the keypad locations on the chartplotter. See the manufacturer's owner's manual for complete operation instructions.



COCKPIT CARPET

If equipped, cockpit carpet features a forty ounce weight with an “aqua tread” slip resistant backing. As required snaps are installed.

When storing the carpet, roll it up verses folding it. If the carpet gets wet dry it out before storing it to help prevent odors from developing. Unsnap individual fasteners carefully when storing carpet to help protect snaps from pulling out. Do not yank on the carpet to remove it. Periodically use some petroleum jelly to lubricate the snap mechanism and to help prevent corrosion.

Note: Always roll up the carpet and store it in a locker or the cabin before towing the vessel on the highway. This will prevent the carpet from blowing out of the boat. Also, make sure the windshield is completely locked and the transom door is latched. For extra long distances it is a good idea to tape the windshield locking mechanism and the transom door latch.

Equipment Operation

STERN LIGHT

The stern light plugs into a socket located on the starboard aft deck. Remove the cover. Notice the screw in the stern light pole. It must line up with the slot in the rear of plug. Insert the stern light into the base. Push down on the pole to seat the light pole in the bottom socket. Tighten the knob by turning it clockwise to lock the stern light pole in place.

ANTENNAS

If equipped, the boat's antennas are located on the starboard hullside or on top of the optional powertower. The round antenna is for the GPS/Plotter. The VHF antenna is located forward of the GPS antenna. The VHF antenna uses a ratchet mechanism to lay it down for traveling or clearing bridges.

TYPICAL WINDSHIELD WIPER



The vessel features a panoramic wiper which keeps the wiper blade forced against the tempered windshield glass for improved coverage. Do not operate the wiper with a dry windshield. The wiper motor is accessed by removing the vinyl access pad in the salon headliner.

CENTER WINDSHIELD LATCH



The center windshield needs to be latched while the vessel is in motion. To latch the center windshield, turn

the two locks to a full horizontal position. When the boat is at mooring open the center windshield and let it rest on the magnet to secure it.

COMPASS



The compass is set up at the manufacturer to ensure it is accurate. If in doubt it can be zeroed in by using a non-magnetic type screwdriver and adjusting each of the

compensator screws as recommended. Refer to the compass manual in the owner's information pouch. Also, a compass can be checked while underway for variance and deviation by comparing your heading with a nautical chart. Compass error is part of the calculation.



SPOTLIGHT

The spotlight/floodlight uses a high-powered, dual focus sealed beam bulb. With an output of 72,000 candlepower, the unit can illuminate objects up to 1/4 mile away. Notwithstanding, the 30,000 candle power spotlight is perfect for docking or mooring.

The unit rotates up to 350 degrees and as a vertical arc of 70 degrees and features an easy to use “joystick” style remote control. The spotlight uses a 12 volt operating system and is constructed of stainless steel or chromed brass for years of carefree service.



EMERGENCY HATCH LIFT SYSTEM

Should the batteries become low or “dead” due to some unforeseen electrical problem there is an emergency hatch lift panel found under the port cockpit cushion.



To use open the door remove the boot from the red (positive) post. Keep it for reinstallation. The negative post is silver/black. Hook up a set of top post style jumper cables to the posts observing red to red and black to black and then observing the same color polarity on the jump battery.

Make sure cables are not touching anywhere. Activate the helm hatch switch to open the engine hatch.

Equipment Operation

HELM SEAT (ADJUSTMENT)

The helm seat features a leaning bolster along with fore and aft mobility. To adjust the helm seat follow these steps:

HELM SEAT FORWARD CUSHION

Pull bar to port and push seat to travel aft
Pull bar to port and pull seat to travel forward

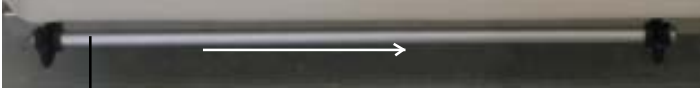

Fore & Aft
Adjustment
Rod

1. To change the forward seat to the leaning bolster position, simply pivot the bolster 90 degrees to the full stand up position. Make sure it is securely in place before sitting on it.
2. To change the fore and aft direction, pull the adjustment rod to port while pushing or pulling the seat in the direction you want to travel. When you release the rod move the seat slightly to find the nearest detent.



DECK SUNPAD

WARNING:

DO NOT OCCUPY THE DECK SUNPAD WHILE VESSEL IS MOVING.



CONVERTIBLE ULTRALOUNGE

The aft cockpit features a 4 position aft seat and sun lounger. Using the handle on the port forward lower section of the seat you can push or pull on the lever which will convert the seat to a huge sun lounger.

The backrest can be positioned as to form a sun lounger position head support or the headrest can be angled up for aft viewing as shown in the lower photo.



POSITIONING HANDLE

FORWARD FACING SEAT POSITION



AFT FACING SUN LOUNGER POSITION
WITH FLAT HEAD REST



AFT FACING SEAT POSITION



AFT FACING SUN LOUNGER POSITION;
TILTED HEAD REST

Equipment Operation

CABIN DOOR



The cabin door features a lock. Keep the cabin door completely closed when the boat is in motion.

When docked, the cabin entry door can be held open by flipping the door stop 180 degrees. This will prohibit the door

from accidentally closing, a great feature with children on board.

FORWARD & SIDE DECK WINDOWS

The lower deck and side windows are tempered glass similar in construction to an automobile windshield. They are tinted and generously light up the entire interior. In addition, curtains are provided for the side windows and a set of black-out shades are available for the lower deck windows.



AVOID BODILY INJURY!

**DO NOT STEP ON WINDOW SURFACES
AS THEY MAY BE SLIPPERY AND
COULD CAUSE A FALL!**

TRANSOM DOOR



To lock the latch pull up on the transom door. Shut the door. Once it reaches the closed position the assembly will stop and take a down direction which will lock the door. To release the door, pull up on the door and push aft.

Read and understand the transom door warning label.



TYPICAL POWERTOWER



The powertower if installed hinges forward using an electric hydraulic ram system through a momentary switch marked tower or arch. The illustration above shows the tower in the forward position to clear a bridge.

Before operating tower make sure all passengers maintain a safe distance from tower hinge mechanisms!

Position the powertower to the lowest forward location before attempting to tow the vessel on the highway to avoid vessel damage from low hanging objects/bridges.



The boat operator, crew and passengers shall read and understand the above caution label.



If a powertower is installed, a relay box with a 60 amp breaker serves as overcurrent protection for the lift actuator mechanism circuit. If overloaded the breaker will “pop” and will need to be reset. Find the cause of the overload and repair as needed before resetting the breaker.

Equipment Operation

TYPICAL CANVAS

Following is an overview of the canvas system. The canvas parts consist of the bimini top, side curtains, aft curtain, windscreen and if equipped the bimini camper canvas along with bows and hardware.

The canvas requires a set installation procedure which makes the job easier and faster. Sometimes a second person can help in the canvas set-up. Once the skipper has gained experience he will find shortcuts to the installation process. Normal installation requires no special tools. Never fold canvas parts containing clear vinyl windows such as windscreens, side or aft curtains since the clear windows could be damaged. This is especially true in colder climates. Roll all canvas parts and make sure the vinyl windows are dry to prevent debris forming on the window material. Store in a clean, dry environment. A small portion of silicone spray on the zippers and vasoline on snaps helps canvas parts fasten easier.

Bimini Top Information

When towing the vessel on the highway the canvas must be set in a stowed position with all boots zipped up and appropriate bows and canvas parts fitted inside the boots. The towing location takes the form of an angle position slanted toward the aft end of the vessel to help resist air created by highway towing. When towing make sure all lanyards are secured in the jaws and all zippers are pulled to the ends.



WARNING

**THE COCKPIT COVER
AND BIMINI CANVAS
ARE NOT DESIGNED TO BE IN PLACE
WHILE TOWING AT HIGHWAY SPEEDS.
REMOVE ALL CANVAS PARTS AND
SECURE BIMINI TOP IN BOOT
BEFORE TOWING.**

To set up the bimini top follow these steps:

1. Ensure the cabin entry door is shut securely to prevent a fall while installing the canvas.
2. Unzip the bimini top boot and store it for future use.
3. Pull the bimini top forward to unfold the entire top.
4. Make sure the forward bow support locking pins are fully engaged into the clevis connectors for both port and starboard. Do the same with the aft bow support and any connector hardware. See illustration 1.
5. Leave all adjustment straps disconnected at this time.
6. With the bimini top still loose but rotated forward install the top zipper of the windscreen. Next, unzip the vertical zipper on both sides of the windscreen to fasten the deck snaps. This can also be done by a second individual on the forward deck.

Typical Canvas Descriptions





Chapter 7

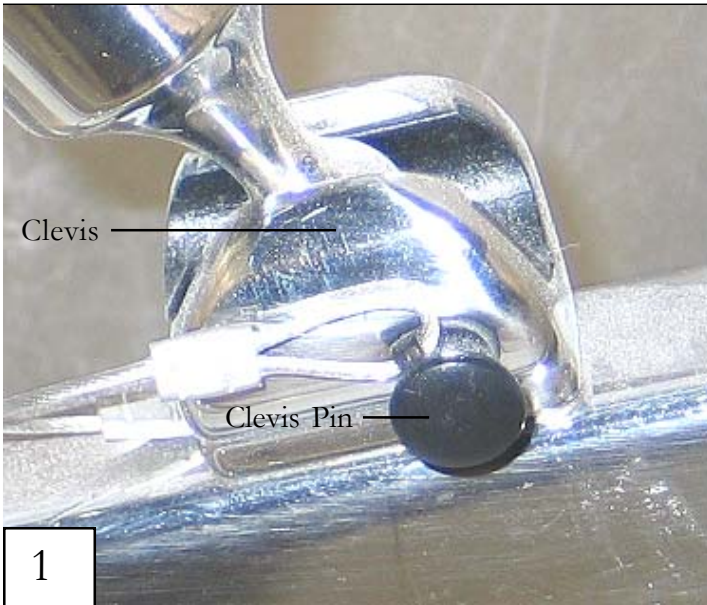

9. Zip the aft curtain to the aft bimini canvas. Then snap it completely around the stern deck. It may be easier to accomplish the above task with the flap zipped out in order to reach all the snaps. Finally, rezip the flap shut and fasten all connectors upon leaving the vessel.

7. The side curtains usually are marked port and starboard. Zip the appropriate side curtain to the bimini top. To access the side curtain deck snaps leave the vertical zipper loose so you can slide your hand in and out to fasten the snaps. After all snaps are fastened zip the vertical zipper on both side curtains.

8. Notice the 2 forward adjustment straps. Lengthen or shorten the straps as needed to obtain the desired top tightness. *While running the vessel twist the straps as needed to eliminate whistling noise.* See illustration 2.



Equipment Operation

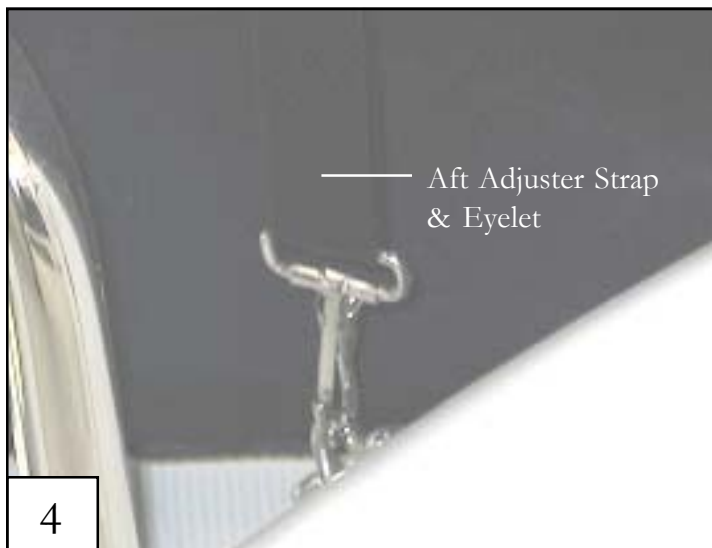

CAUTION

EXHAUST FUMES FROM ENGINES CONTAIN DEADLY CARBON MONOXIDE (CO) GAS. BOATS WITH CANVAS OR POOR VENTILATION ARE MOST LIKELY TO COLLECT FUMES. CO SICKNESS SYMPTOMS INCLUDE HEADACHES, NAUSEA, & DIZZINESS. DO NOT MISTAKE FOR SEA SICKNESS! SEE CHAPTER ONE IN THIS MANUAL FOR FURTHER INFORMATION.

CAUTION

PREVENT POSSIBLE INJURY AND/OR PROPERTY DAMAGE! THE COCKPIT COVER IS DESIGNED TO PROTECT THE BOAT FROM THE ELEMENTS. **DO NOT TRAVEL WITH THE COCKPIT COVER INSTALLED AS IS NOT DESIGNED FOR HIGHWAY USE!**



Cockpit Cover

To install the cockpit cover follow these steps:

1. Locate the front of the cover and fasten it to the windshield snaps.
2. As you snap the cover from bow to stern find the cockpit poles and install each one to the canvas cutouts designated for them. It is a good idea to mark them for future use. Finish up fastening the snaps on the stern and exit via the swim platform. See the illustration on previous page.
3. Do not use the cockpit cover as the only means of supporting the vessel for winter storage. The cover will not support heavy snow/ice loads. Use an approved mooring cover in colder environments or better yet store the vessel inside a building.



BILGE/SUMP

Bilge Overview

The bilge often referred to as the sump houses many of the equipment packages including the engines, batteries, and the live aboard systems.

An introduction to the equipment will be discussed. For more specific information, refer to the manufacturer's manual located in the owner's pouch. See the maintenance chapter for additional information.

CAUTION

AVOID POSSIBLE PERSONAL INJURY
DUE TO MOVING PARTS!
DO NOT ACCESS THE BILGE WITH
ENGINE RUNNING.

Engine

The engine affords easy access by lifting the hatch. Before each outing check the bilge for loose fasteners, exhaust and fluid leaks, corroded hardware and **perform a fume sniff test besides running the bilge blower.**

Refer to the manufacturer's owner's manual for more specific information located in the owner's document pouch.

Batteries

Your vessel features 2 cranking batteries. They feature wet type cells. The engine cranking batteries are Group 31. All batteries require periodic inspection and maintenance.

The electrolyte and terminals need to be checked for looseness and corrosion. See the maintenance section for additional detailed information.

DANGER

AVOID EXPLOSION OR FIRE
FROM HYDROGEN GAS PRODUCED
BY BATTERY CHARGING!
NEVER SMOKE OR USE AN OPEN FLAME
IN THE SUMP OR AROUND BATTERIES.
AVOID PRODUCING ANY SPARKS IN THE
VICINITY OF BATTERIES. AVOID TOOLS
WHICH MAY COME IN CONTACT WITH
BATTERY POSTS & METALLIC OBJECTS
IN THE SUMP.

CAUTION

AVOID POSSIBLE EYE DAMAGE AND SKIN
BURNS! WEAR GOGGLES & RUBBER
GLOVES WHEN WORKING WITH BATTERIES.
AVOID CONTACT WITH SKIN, CLOTHING OR
EYES. IN CASE OF CONTACT,
FLUSH WITH WATER FOR AT LEAST 15
MINUTES. IF SWALLOWED, DRINK LARGE
QUANTITIES OF WATER OR MILK.
FOLLOW WITH MILK OF MAGNESIA, BEATEN
EGG OR VEGETABLE OIL.
GET MEDICAL ATTENTION IMMEDIATELY!

Bilge Pump & Float Switch

The bilge pump and automatic float are located in the sump. The pump grates should be checked periodically for debris. Remember if an icon lights up on the bilge pump dash switch, the automatic side of the bilge pump is activated. Investigate the cause of the problem immediately since using the pumps continuously could run down the batteries and may be a sign of a more serious situation.

Equipment Operation

BILGE/SUMP EQUIPMENT OVERVIEW



The sump features electric rams which open the hatch in a forward position affording easier sump maintenance and component visibility. Equipment found here needs inspection periodically and some before each outing. Become familiar with each of the components by reading the individual owners manuals and equipment guides found in your document pouch.

Checking the engine oil and power steering fluid levels must be done before each boating outing. Carry extra oil and power steering fluid as recommended by the engine manufacturer. If generator equipped, check its fluids before each outing. Also, check the sump for water & exhaust leaks before disembarking.



AUTOMATIC FIRE EXTINGUISHER

The Fireboy automatic fire extinguishing system is located in the bilge along the firewall. See the illustration. The system uses an environmentally friendly agent FE-241 which has been approved by the EPA to replace the old Halon agent. This system is formulated only for use in the engine space or bilge of your vessel. FE-241 is to be used with gasoline fuel systems only.

Fireboy systems are not nor are they intended to be explosion suppression devices. **Boat owner's still need to take normal precautions for gasoline fumes and use blowers as recommended.**

OPERATION

Read the information in previous chapters regarding the dash installed portion of the fire extinguisher system. Should the system ever activate you may hear a loud sound similar to that of small arms fire, followed by a rushing air sound.

The system will show actuation whenever the ignition key is ON and the indicator light is OFF. The actual actuation time when a fire occurs is dependent on the severity of the fire.

When the automatic fire extinguisher activates IMMEDIATELY SHUT DOWN ALL ENGINES, POWERED VENTILATION (BLOWER), ELECTRICAL SYSTEMS AND EXTINGUISH ALL SMOKING MATERIALS. DO NOT OPEN THE ENGINE COMPARTMENT IMMEDIATELY DUE TO THE POSSIBILITY OF FEEDING THE FIRE AND A FLASHBACK OCCURRING.

Allow the agent to "soak" the compartment for at least 15 minutes and wait for hot metals and any fuels to cool before inspecting for the fire cause. Have approved portable fire extinguishers available as a backup.

WARNING

**AVOID SERIOUS INJURY OR DEATH!
DO NOT BREATHE FUMES OR VAPORS
CAUSED BY A FIRE
AS THEY ARE HAZARDOUS & TOXIC.**

NOTICE

**READ AND UNDERSTAND THE
MANUFACTURER'S OWNER'S MANUAL
LOCATED IN THE DOCUMENT POUCH.**

Manual Operation

Read the information regarding using the manual release portion of the fire extinguisher system and know what to do if a fire emergency develops.



Manual Release Handle

Pin

Equipment Operation

TYPICAL SWIM PLATFORM

WARNING!
MAXIMUM CAPACITY
OF SWIM PLATFORM
750 POUNDS
453 KG

The swim platform is used to enter and exit the water. Never dive from the platform. Make sure you do not exceed the platform weight capacity label found inside the ladder cover or in the

owner's pouch. Periodically inspect all swim platform fasteners and hardware for tightness and corrosion build-up.

 **CAUTION**

AVOID PERSONAL INJURY OR PROPERTY DAMAGE!
DO NOT USE THE SWIM PLATFORM CLEATS FOR TOWING OR ANY TYPE OF PERMANENT MOORING OR DOCKING.
USE BOW, STERN AND SPRING LINE CLEATS FOR MOORING PURPOSES.

 **WARNING**

AVOID SERIOUS INJURY OR DEATH!
DO NOT OPERATE THE VESSEL WITH PEOPLE ON TOP OR HOLDING ON TO THE SWIM PLATFORM STRUCTURE OR HARDWARE.

 **WARNING**

AVOID SERIOUS INJURY OR DEATH!
DO NOT ALLOW ANYONE TO TEAK SURF BY USING THE SWIM PLATFORM AND/OR HARDWARE.





CHECK FOR TIGHTNESS & CORROSION

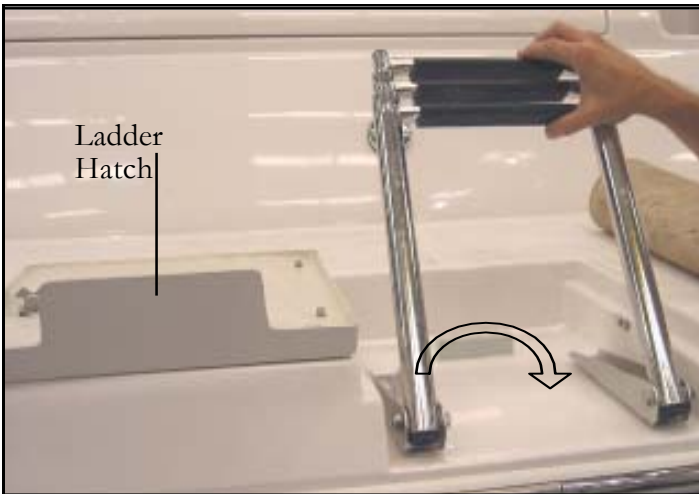

TYPICAL SWIM LADDER

When using the swim ladder, open the hatch and slide the ladder out to the end of the travel. Then rotate the ladder over and let it down gently. Keep your hands and fingers clear of any moving ladder parts especially under the hinged top area between the ladder and swim platform. Rotate the ladder up and close the fiberglass hatch when returning to the vessel. ***Insist that only one person use the ladder at a time and that people do not use the any part of the outdrive or propeller(s) to climb up on the swim platform or ladder. Bodily injury could occur from falling or body parts coming in contact with sharp metal objects such as propellers.***



 **WARNING**

AVOID BODILY INJURY!
TURN THE ENGINE OFF
AND REMOVE THE IGNITION KEY
WHILE PEOPLE ARE SWIMMING
NEAR THE VESSEL, USING THE SWIM
PLATFORM OR LADDER.



 **WARNING**

AVOID SERIOUS INJURY !
KEEP HANDS, FINGERS AND FEET
CLEAR OF ANY LADDER MOVING PARTS!

Equipment Operation

DEPTH SOUNDER

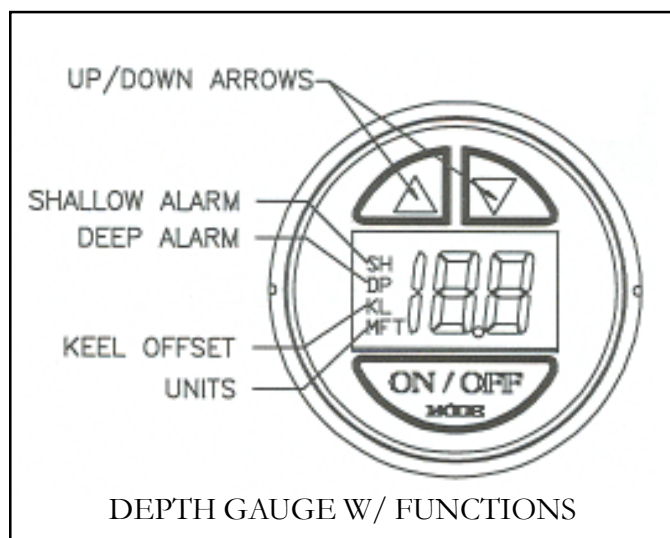

In theory the depth gauge picks up a bottom signal sent through a transducer to the helm gauge unit which is converted to readings in feet, meters, or fathoms and displayed on the gauge. The unit features shallow or deep water alarms, both of the audio and visual type, and keel offset.

General Description.

The optional depth finder will display depths of 2-199 feet, 1-92 meters, or 1-54 fathoms. To accommodate greater depths to be displayed in the "ft" feet mode the depth sounder will automatically change to "F" fathoms mode and continue to display depths to around 54 fathoms.

When the depth decreases below 200 feet the display will return to the "ft" mode. Limits on depth will vary depending on transducers and bottom conditions.

If the reading is less than 19.9 feet, meters, or fathoms, 1/10th increments will be displayed. If the reading is more than 19.9 feet, all readings will be in whole numbers.

The depth finder features an audible and LCD displayed depth alarm with adjustable shallow and deep limits and a depth below keel offset feature. These settings once made are stored in memory and will remain even if the battery is not connected.

OPERATION

Power On. When the helm is powered up by the key switch 12 volt DC energy is available at the depth gauge along with the remainder of the instrument cluster. You do not need to press the "ON/OFF MODE" keypad.

The LCD will illuminate showing the depth and the type of units selected; feet (FT), meters (M), or fathoms (F). To deactivate the depth sounder, hold the "ON/OFF MODE" keypad for 4 seconds. If you press the "ON/OFF MODE" keypad again the unit will be reactivated.

Depth Alarm. Shallow mode: If you press the "ON/OFF MODE" keypad again the "SH" shallow depth alarm setting is displayed. This is the shallowest water that will energize the alarm. Press and hold the up or down arrow keypads to adjust the reading to the desired depth.

Depth Alarm. Deep Mode: By pressing the "ON/OFF MODE" keypad displays again the "DP" deep depth alarm setting. This is the deepest water that will energize the alarm.

Press and hold the "UP" or "DOWN" keypads to adjust the reading to the desired depth. When the shallow depth setting is read by the depth finder, the "SH" will flash on the LCD and the audible alarm will sound in a rapid sequence. When the deep depth setting is read by the depth finder the "DP" will flash on the LCD and the audible alarm will sound at 2 beeps per second.

Note: To fully deactivate the alarm, reset it to zero. Pressing the "ON/OFF MODE" keypad temporarily deactivates the alarm. To reactivate the alarm press the "ON/OFF MODE" keypad until the depth reading appears.



Keel Offset. By pressing the “ON/OFF MODE” keypad again displays the “KI” keel offset setting. It can be set so the depth finder shows the depth below the transducer or the depth under the keel. Press the “UP” or “DOWN” arrow keypads to adjust the reading to the desired depth no further than 19.9 feet.

An example would be if the keel bottom is 3 feet below the transducer and you desire the depth sounder to read the depth below the keel, the display should be adjusted to read 3.0 FT.

Note: Once the keel offset is programmed, the shallow and deep alarms will be energized by the depth under the keel.

Units. Pressing the “ON/OFF MODE” keypad again displays “UN” on the LCD indicating the units mode.

Press either the up or down arrow keypads to set the units desired to (FT) feet, (M) meters, or (F) fathoms. Once these units are set, they will remain the same for all modes. By pressing the “ON/OFF MODE” keypad again returns the depth finder to normal operation.

Equipment Operation

SIRIUS XM SATELLITE RADIO

If installed, satellite radio features over 120 channels of music entertainment completely commercial-free along with sports and news channels. It emphasizes the music and entertainment you want. Channels use the most updated digital filtering available for the clearest sound. The system uses three satellites flying over the United States for coast to coast coverage with high elevation angles. The result is a clearer line of sight and less signal blocking.

The system consists of the Fusion stereo receiver (sometimes called the head unit), radio tuner and antenna. With these components and an paid active account your satellite system can be activated.

SIRIUS XM SATELLITE RADIO ACTIVATION

It is the customer's responsibility to activate his account for the Sirius XM satellite radio in order to receive the radio service..

A. To activate your radio subscription, you will need the Sirius XM ID (SXID) which uniquely identifies your tuner. The 12 digit SCID is displayed on the LCD on initialization. They will be displayed on Channel O.

Unit must be completely installed and the antenna must have a clear view of the sky.

B. Power on your system and make sure you are receiving a strong signal, where you can hear the audio on the Sirius XM preview channel 184. If you are not receiving Channel 184, please refer to the STEREO manufacturer owner's manual.

D. Call SIRIUS sales support 1-866-635-2349 or customer care 1-888-539-7474

E. Note: Please have your name, address, phone number and the SIRIUS ID#ESN available for the agent or go online at <https://care.siriusxm.com/> and follow the prompts to activate your subscription.



TRAILERING

This section covers trailering basics including equipment, maintenance, and techniques of trailer usage. ***Check with state and local agencies for detailed information on required equipment, safety issues such as brakes, and licensing.***

BEFORE TRAILERING

Before trailering your boat, be sure to check the air pressure of your tires for the recommended inflation rating. Also, be certain that your tow vehicle is in good working order.

Stow all gear to be carried properly, especially heavy items such as batteries or anchors. Be sure these items are secured. Don't overload and try to carry too much on your trailer.

Give consideration to the weight distribution of your trailer. If the rear end of your vehicle sags, chances are the load is positioned too far forward on your trailer.

This can make it especially difficult to drive safely, as the hitch may be in danger of striking the road. Also, this situation can be caused by worn rear shock absorbers.

One option is to install a set of air shocks which will assist in supporting the load. As a rule of thumb 5 to 7 percent of the total load should be on the trailer tongue.

Check all lights to ensure they are in good working order. You may find it helpful to ask someone to check your turn signals, brake lights, and towing lights while you remain in the vehicle. Lubricate all winch parts.

Be certain that the trailer winch cable is securely attached to the boat's bow eye and the cable lock is engaged. Make sure the bow of the boat is snug against the bow stop at the winch stand. Tie another line or secure an extra cable to the winch stand and boat bow eye as a backup system.

Be certain that your trailer is of rated capacity for the size and weight of your boat, including the weight for all fuel, water and gear. Your authorized Regal dealer can advise you on the proper trailer capacity and tongue weight (the weight exerted on the rear of your vehicle). Never use a bumper mounted trailer hitch. Always use a bolted or welded frame-mounted hitch, class 2 or 3. Consult your Regal dealer for more information.

Should your trailer be equipped with surge brakes, that is brakes on the trailer that cut in with a very slight delay when your brakes are applied, be sure to follow recommended service and maintenance instructions. Be sure that the trailer master cylinder is filled with the recommended fluid before trailering your boat. Inspect the trailer brake lines for any leakage. Also, if you notice brake fluid on the inside of the tires, you may have a wheel cylinder leaking. Consult a professional.

Never place your hands between the trailer hitch coupling and the hitch ball on your towing vehicle while hooking up. Be sure the tongue jack is in the full up position before departure. Be certain safety chains are criss-crossed and secured; do not allow them to drag on the road.

Check the trailer harness often for signs of fraying. Check the harness connector for corrosion. Make sure the trailer harness when connected to the trailer has enough slack for turning

Check the wheel bearings for wear periodically by a professional. On most trailers, there is a zerk fitting on the wheel hub to add the proper lubricant to the wheel bearing with a grease gun that can be purchased at a supply house or marine store.

Finally, make sure everything is secured in the boat and the cockpit cover is snapped. Tilt the outdrive up to clear the road and any bumps that might occur while in transit.

Equipment Operation

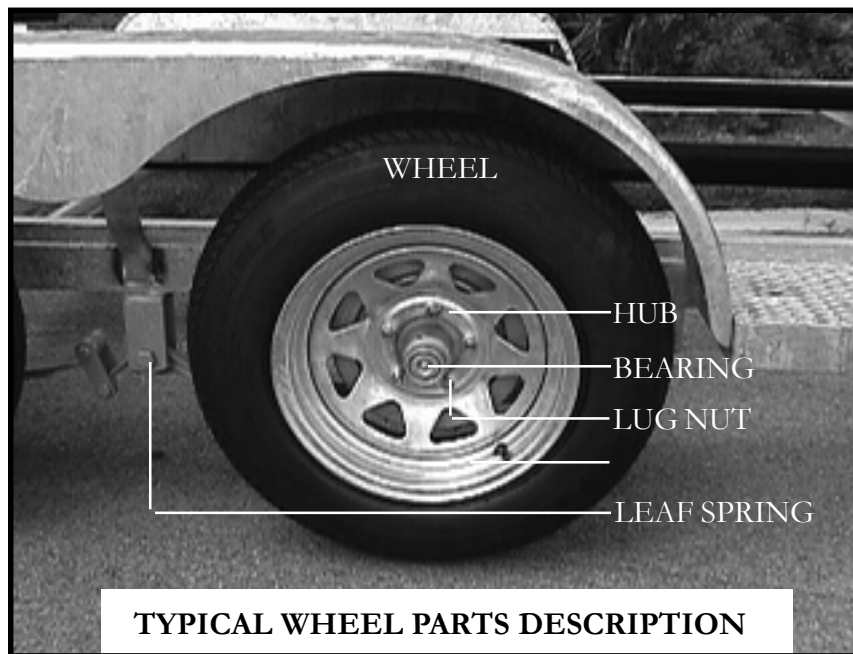
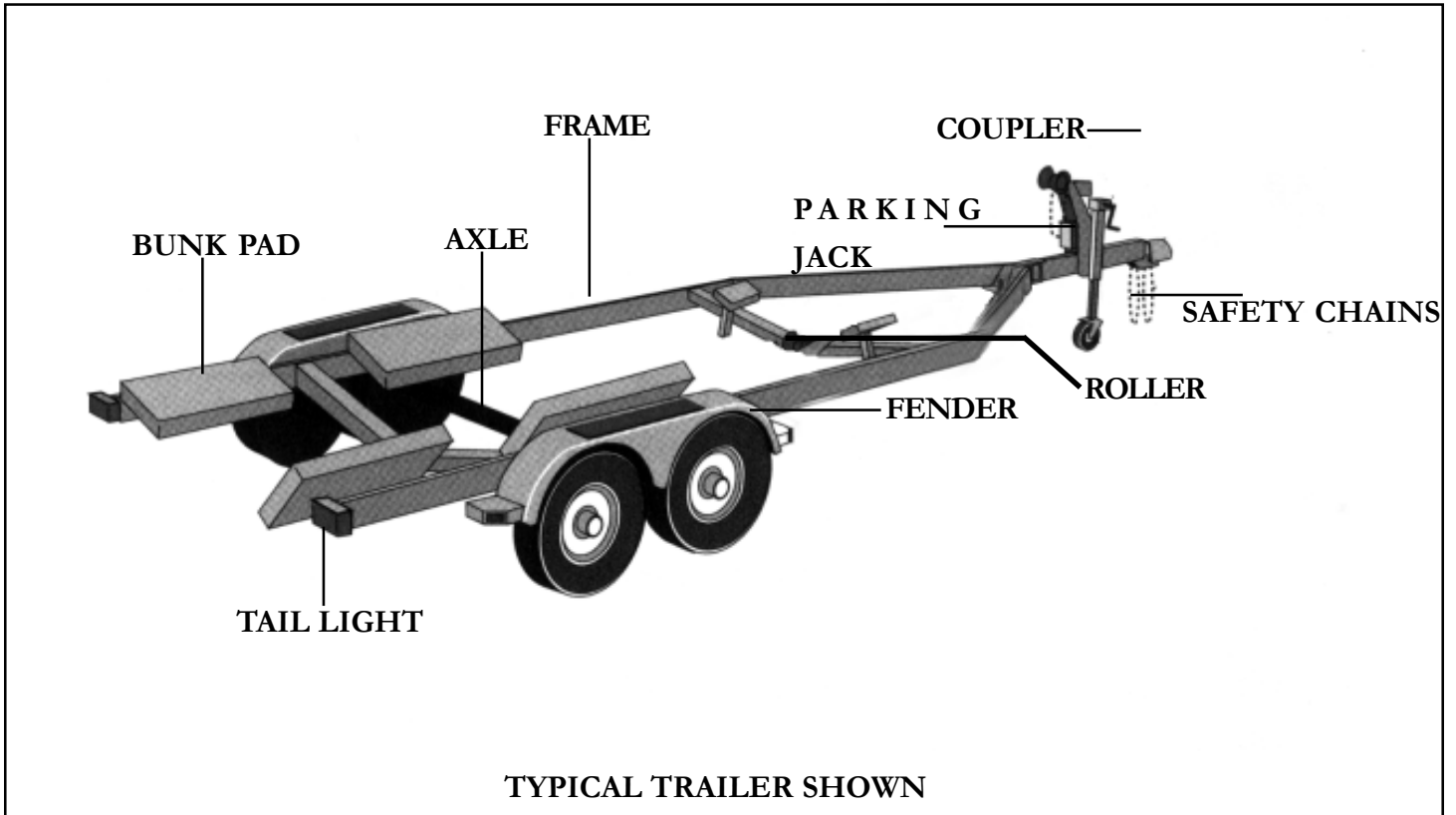

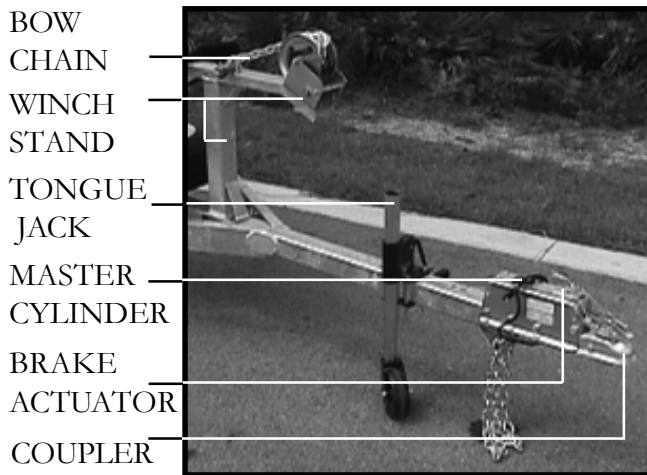

TYPICAL TONGUE SECTION

DRIVING

Practice maneuvering the vehicle and trailer in a large, empty parking lot or open space. If you practice slowly and cautiously, you will soon develop a feel for maneuvering the trailer properly.

Test your vehicle and trailer brakes before departure along with the lights. Also, be sure you pack a tool kit with extra bulbs, fuses and fluids.

Drive as smoothly as possible, anticipating your stops and giving yourself plenty of room for turning and stopping. Avoid any quick turns or sudden jerks of the steering wheel.

Remember to maintain safe speed limits. It takes longer to stop your loaded boat. Allow enough more room to the front in bad weather.

Keep an eye on your rig through the rear view and side mirrors. If your rear view mirror is obstructed, purchase a set of side mirrors that extend out over the side of the vehicle for increased visibility. It is a good idea to install a set of round mirrors to the side mirrors as they help identify blind spots.

Plan to stop periodically on your way to check the trailer hitch for tightness, harness connector, tires, wheel bearings. Also, check to make sure the cockpit cover is secure and the load is balanced.

Be sure to buy a suitable set of tie downs which can be attached to the boats' stern eyes and the eyelets provided on most trailers. Tighten them securely and neatly fold up the extra strap material and secure it with tape so it doesn't loosen and dangle on the road.

Check the trailer lug nuts for the proper torque. Use a foot pound wrench and torque in a star sequence to the correct poundage as recommended by the trailer manufacturer. Torque the lug nuts at half the poundage on all nuts. Then set the torque wrench to the full poundage and fasten to the last foot poundage figure.

Check the trailer tires often for voids, excessive wear or out of round tire conditions. If the trailer seems to vibrate you may have a bad tire or one that is unbalanced. These wheels can be rebalanced at most automotive or tire shops. Never pull a boat on a patched tire. Buy a spare tire and wheel. Mount it on the trailer speedy installation should a blow out occur.

Equipment Operation

LAUNCHING

Serious accidents can occur at the launching ramp. Therefore, it is imperative you be alert and attentive during launching and docking activities. Study the ramp area and surrounding water for any potential hazards, such as a short ramp or one with a drop off at the end. If you are uncertain of the conditions, ask someone else who has just used the ramp if there are any peculiarities to the area.

Attach 2 lines, one each at the bow and stern, to control your boat once it is off the trailer. If you need additional fenders to keep the sides of the boat from banging against walls, put those on as well

Unhook the stern tie-downs and the winch line to the bow. Unplug the trailer harness connector so the trailer lights won't blow out when they come in contact with the water.

When backing in, have someone assist, giving the palms up stop signal when the boat is in deep enough water to float off, or when the rear wheels of your vehicle approach the water's edge.

After your boat is floating freely, position it clear of the trailer before pulling out of the water. If there is no one to help you, secure one of the lines you've attached from the boat to the dock and use the other line to pull the boat off trailer. You should have someone assist you.

	WARNING
AVOID BODILY INJURY ! BOAT RAMPS ARE VERY SLIPPERY. DO NOT ATTEMPT TO WALK OR STAND ON AN ANGLED BOAT RAMP.	

	CAUTION
AVOID LOSING VEHICLE TRACTION! DO NOT ALLOW REAR WHEELS TO ENCOUNTER SAND OR SLIPPERY CONCRETE CONDITIONS.	



BACKING A TRAILER

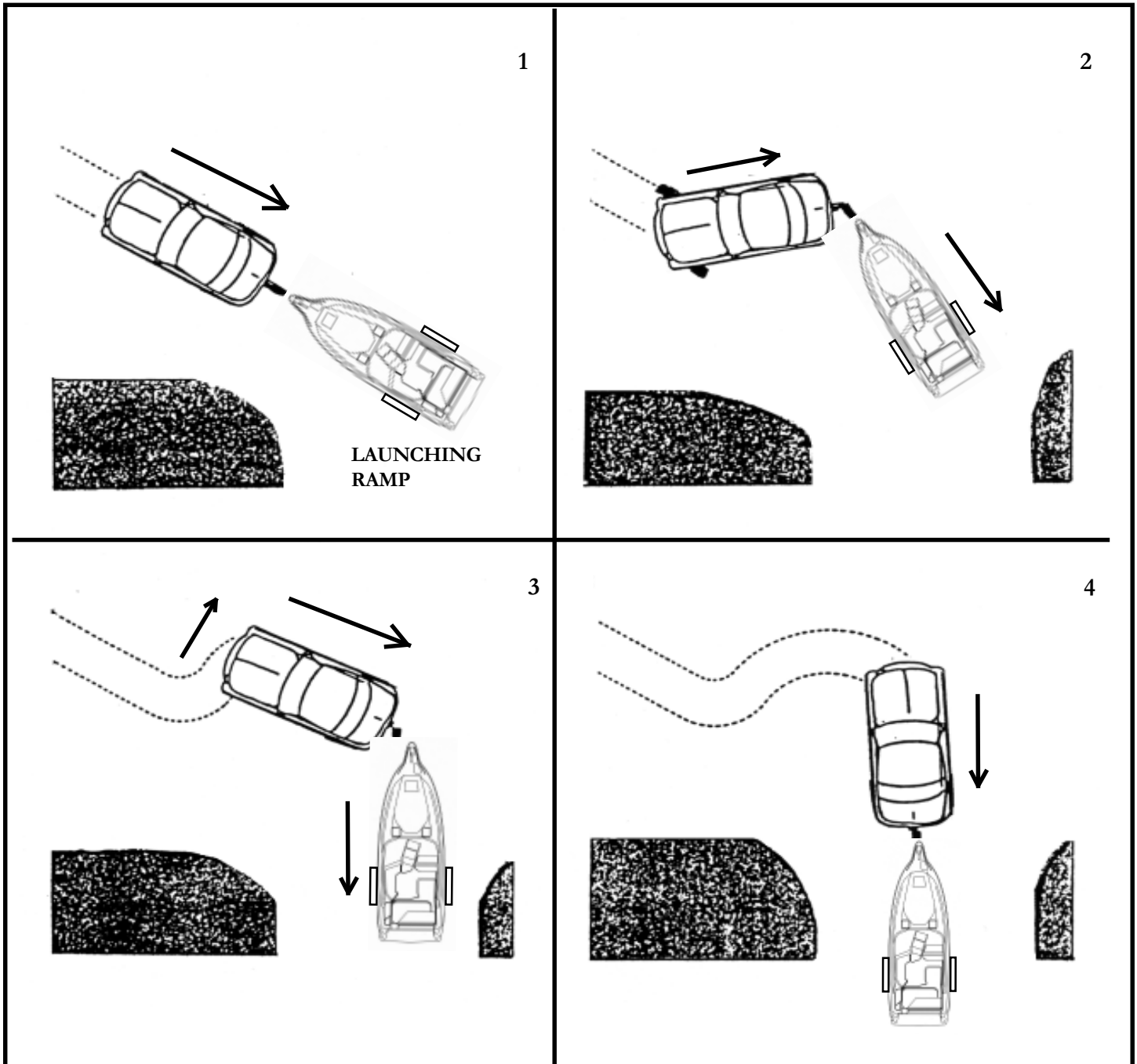

Equipment Operation

A trailer backs in a direction opposite to an automobile. In 1, driver swings the rig near the launching ramp. In 2, the driver cuts the vehicle toward the driveway. In 3, the driver cuts the vehicle wheels to the left and then backs into the ramp as the trailer moves to the right. In 4, the driver straightens the vehicle wheels to follow the trailer as it backs down the ramp.

NOTICE

ALLOW WHEEL BEARINGS AND LIGHTS TO COOL BEFORE SUBMERGING THEM.

Consider disconnecting the trailer harness from the vehicle harness at the ramp. That way the brake or running lights will not work thus limiting the chances that a bulb could burn out when backing the boat in the water especially in colder climates.

LOADING BOAT

The most important thing to remember when getting your boat out of the water is that often the ramp will be crowded. As you approach the ramp, make a visual inspection of the traffic, both at the ramp and all around you. This is an important time to use caution, courtesy, and common sense. While you may feel it's your next turn, another boater may not be as courteous. Don't insist on your rightful place in line; it could lead to disastrous consequences in the confines of a crowded boat ramp. If there is any perceived danger, stand off until you can safely approach the ramp.

Back your trailer down to the water's edge. At this point it is a good idea to let a sufficient amount of line out of the winch to reach the bow eye. Make sure you disconnect the trailer harness to keep the bulbs from blowing out due them being subjected to the cold water.

On roller or bunk style trailers back up until the aft roller is just at the water level. This allows you to hook up the winch cable and to start cranking the boat on to the trailer properly. This method gives you a good starting point and helps keep the boat centered on the trailer as it is reloaded. It may be necessary to further back the trailer into the water to allow cranking up the boat.

Once the boat is positioned correctly on the trailer have someone hook up the winch cable hook to the bow eye. Also, this will help keep the boat bow against the trailer roller. Shut down the engine and run the outdrive up to the top of the trailer position. With the bow snug against the roller, start to crank the boat up onto the trailer. Make sure the hull bottom or keel stays in the center of each roller as it is being cranked on the trailer.



On bunk style trailers, watch the bunks to make sure the boat is centered as they usually do not touch any rollers other than the aft one because the boat weight is being supported more by the bunks as it is cranked onto the trailer.

Stop cranking the winch when the boat bow contacts the bow roller. Be sure the winch is in the locked position. Stand back and make sure the boat is centered on the trailer.

After pulling your boat away from the ramp, be sure to go through all the checks involved before departure. Reinstall the harness connector and check the lights, brakes, safety chain, winch, hitch, wheel bearing and tie downs. Make sure the boat is covered properly and all loose gear is stowed.

Remove the hull drain plug to exit any excess water in the bilge. Make sure you reinstall the hull drain plug and securely tighten it.

	WARNING
AVOID BODILY INJURY ! DO NOT LET ANYONE STAND NEAR THE WINCH OR CABLE AS IT COULD SNAP	

	CAUTION
HULL BOTTOM DAMAGE COULD RESULT FROM THE BOAT RESTING ON THE TRAILER FRAME. AVOID BACKING THE TRAILER TOO FAR BACK IN THE WATER.	

Cosmetic Care & Maintenance

COSMETIC CARE



This section covers the care and maintenance of your vessel. Many cosmetic care topics including exterior hardware, upholstery, fiberglass and canvas are covered. Engine and propulsion system information is

found in the engine manufacturer's manual. As always, refer to the owner's information pouch and the various vendor owner's manuals for more detailed analysis of cosmetic care items.

UPHOLSTERY

Cockpit and interior vinyl require periodic cleaning to maintain a neat appearance and to prevent the build up of dirt and contaminants that may stain and reduce the vinyl life if they are not removed. The frequency of cleaning depends on the amount of use and conditions to which the vinyl is subjected.

Most common stains can be cleaned using warm, soapy water and clear rinses. Scrubbing with a soft bristle brush will help loosen soiled material from embossed surfaces and under welting. If the stains are not removed with the above method use a mild cleaner such as Fantastic. This cleaner should be used only as needed and not the normal means.

With more stubborn stains, rubbing alcohol or mineral spirits may be tried cautiously. Widespread solvent use can severely damage or discolor vinyl.

Try to remove stains immediately before they have a chance to penetrate the surface of the vinyl.

Powdered abrasives, steel wool, or industrial strength cleaners are not recommended for cleaning our vinyl. Lacquer solvents will cause immediate damage. Dilute chlorine bleach before using. Do not wax the vinyl as it may cause cracking. Always wear protective gloves and make sure there is sufficient ventilation when cleaning vinyl. Wear eye protection.

Remember that suntan oil will damage vinyl. **Use suntan lotion instead of suntan oil.** Exposure to the sun is a natural enemy of vinyl upholstery. For maximum life, keep the vessel covered with a cockpit cover when not in use.

CARPET

Use approved carpet cleaners only. Always try on a test area first. Many spots and spills can be removed using a cleaner combined with a clean, white terry towel. Try not to soak an area excessively and do not use solvents because most interior marine carpet is rubber backed and glued in place. Solvents will break down the backing and fibers.

PLASTICS

Use plastic cleaners and polishes recommended for marine use only. Use proper applicators. Read all instructions carefully. Test the product in a small area first.



Use a soft rag and always rinse the surface with water. Ammonia based cleaners and abrasives will damage plastic parts.

<h2>NOTICE</h2>
<p>NEVER CLEAN PLASTIC SURFACES WITH A DRY CLOTH OR GLASS CLEANING SOLUTIONS CONTAINING AMMONIA. NEVER USE SOLVENTS OR WIPE WITH ABRASIVES.</p>

INTERIOR FABRICS

Clean flat-good interior fabrics with dry cleaning fluid style cleaners approved for use with soft fabrics. Allow adequate ventilation and follow the label instructions carefully. Use a soft cleanser with feldspar to clean stubborn marks or stains on wallpaper. Normal interior vinyl such as the headliner and head need a mild soap and water solution. Rinse immediately with clean water and wipe dry. Always test an area with a cleaner before applying it to a larger area.

CORIAN®

Regal has chosen Corian countertop material because of its elegance and durability. Periodic maintenance will ensure its beauty. Corian withstands heat much better than ordinary countertop materials but you must still use a hot pad or trivet when taking materials directly out of the oven or stove top to protect from damaging the surface. Avoid cutting directly on the surface.

Another feature of Corian countertops is that the material is a non-porous. Therefore, dirt and germs do not penetrate it. Corian will not support the growth of germs and mildew. To disinfect, wipe the surface with diluted household bleach with a ratio of 1 part bleach to 1 part water. To clean the surface of water marks, wipe it down with soap and water and towel dry. For stains use soapy water or ammonia based cleaners.

You can use a Scotch-Brite pad to remove stubborn stains. The Corian is a matte or satin finish. To remove scratches and nicks, sand the surface with 180-220 grit sand paper until the nick is gone. To restore the finish use an abrasive cleanser and a green Scotch-Brite pad. If you wrap sandpaper around a block of wood while sanding the final finish will be flat instead of creating hills and valleys.

FIBERGLASS & GELCOAT

 <h2>CAUTION</h2>
<p>AVOID BODILY INJURY! WAXED GELCOAT SURFACES CAN BE VERY SLIPPERY. DO NOT WAX NORMALLY USED AREAS OF THE DECK, LINER, OR GUNWHALES. DO NOT WAX ANY TEXTURED OR NON-SKID SURFACES SUCH AS FLOORS, WALKWAYS, STEPS, LADDERS OR SWIM PLATFORMS. WEAR ANTI-SLIP FOOTWEAR AT ALL TIMES!</p>

Routine maintenance is the only practical way to keep the surface of your boat looking shiny and new. Most objects left outdoors will gradually deteriorate from exposure to the sun, water, dust and pollution. Such outdoor exposure can cause your boat's gelcoated surface to change or fade. Darker colors tend to fade more rapidly than lighter colors because they absorb more of the sun's rays (ultraviolet and infrared).

Basic maintenance includes monthly washing of the boat's surface to remove normal accumulation of soil and stain. Use a mild detergent such as dishwasher powder or liquid. Do not use automatic dishwasher detergent. Avoid any kind of alkaline cleaners such as tri-sodium phosphate (TSP), abrasives, bleaches and ammonia. For best results use cleaners that are recommended for fiberglass.

Cosmetic Care & Maintenance

NOTICE

WIRE BRUSHES, SCOURING PADS,
OR OTHER ABRASIVE TYPE MATERIALS
AND SOLUTIONS SHOULD NEVER
BE USED ON THE HULL
OR DECK OF YOUR BOAT.
THEY CREATE SMALL SCRATCH
MARKS THAT COLLECT MARINE GROWTH
AND OTHER FOREIGN MATERIALS.

It is recommended that you wax the gelcoat surface twice yearly to prevent loss of gloss and to protect the finish. Use only waxes for fiberglass and follow the label instructions. Apply a 3' x 3' section at a time using clean applicator cloths or a buffing bonnet. When a haze develops, use a power buffer at low speeds (1200-2000 rpm) to remove the haze. Keep the buffer moving to avoid heat build-up. Never wax gelcoat in the direct sun.

When the washing and waxing as recommended does not restore the shine it may be necessary to use a fine rubbing compound. Do not apply rubbing compound in direct sunlight. A power buffer at low speed does an excellent job to remove impurities from the gel coat that cause dulling. Use light pressure and keep the buffer moving. Re-wax after compounding to buff the surface.

“Hairline cracks” or “spider webbing” could develop in the gelcoat surface of a hull or deck. This can be caused by impact or other factors. Small air pockets or gouges may also occur through normal wear. These do not affect the strength of the hull or deck and can be repaired by yourself, a marine professional or a Regal dealer.

The affected area should be chipped or sanded away and a thin layer of color matched gelcoat applied. This layer is then sanded smooth and buffed to its original luster.

Most minor scratches, nicks, and dents can be removed by compounding the surface. Marine type compounds can be found at most auto body supply stores. Specify a number 25 which is a coarser compound or a number 55

being less coarse. Various glazes and polishes are available as needed. Ask your marine professional or Regal dealer for more information. Fiberglass hulls are strong but they can be damaged. A fiberglass hull has virtually no internal stresses. Thus when a part is broken or punctured, the rest of the hull retains its original shape. A severe blow will either be absorbed or result in a definite localized break. A break of this nature should be checked and repaired by a marine professional or a Regal dealer.

MINOR REPAIRS

You will need the following materials for minor repairs:

- Gelcoat
- Clear Liquid Catalyst
- Putty Knife
- Razor Blade
- Fine Sandpaper (400,600,1000)
- Wax Paper (to cover repair area)



WARNING

AVOID BODILY INJURY!
GELCOAT & FIBERGLASS RESIN ARE
FLAMMABLE. WORK IN A WELL VENTILATED
AREA FREE FROM OPEN FLAMES.
DO NOT SMOKE!

For minor repairs refer to the following procedure:

1. Clean the area to be repaired and get rid of any wax or grease residues.
2. Clean out scratches, chips, and nicks.
3. Sand area to be repaired so gelcoat will bond.



4. In a separate container, measure only the amount of gelcoat you will need. Mix a ratio of 2% ratio of catalyst to the amount of gelcoat being used (a spoonful of gelcoat will require only a drop or two of catalyst). Do not pour any unused portions of the gelcoat/catalyst mixture back into either original container.
5. Apply gelcoat to area leaving a slight lift above the surface.
6. Cover the area with wax paper. It will help the mixture to set up faster.
7. Remove wax paper and shave off any extra gelcoat with a razor blade.
8. After the area is shaved smooth, start with the 400, 600, and finally 1000 grit sand papers.
9. Buff the area with compound, polish and a finish wax. You may notice a difference between the repaired area and the original finish due to the natural weathering process.

CANVAS

Boat canvas is in most cases subjected to more severe punishment than practically any other type of material. Moisture, dirt and chemicals from industrial fallout, heat, ultraviolet rays and salt water are all factors which accelerate the deterioration of your boat canvas.

These elements can cause serious damage if left unchecked.

The boat top and other canvas supplied on your Regal boat are manufactured from top quality materials to provide you with years of trouble free service. The following information on the care, cleaning and proper storage of the fabrics and fasteners that make up your marine canvas is being provided to help you maintain the appearance and ease of operation.

Sunbrella is used on most Regal tops, aft curtains, camper enclosures, bow tonneaus and cockpit covers. Sunbrella is a woven fabric made from 100% solution dyed acrylic fiber. It is color fast and will withstand long term exposure to the sun (ultraviolet rays) without excessive fading.

Even though it is treated with water repellency some "misting" through the fabric is typical. A vinyl protective layer you may find has been added to the underside of bimini tops to prevent misting. With new canvas, the greatest potential for leakage is through the sewn seams. Because Sunbrella and the long term thread used is synthetic, the holes created by sewing will not swell up and seal when exposed to water as cotton does. Usually the movement of the fabric in use will move the fibers enough to seal the holes. You may apply Apeal or Uniseal to the seams to speed up this process.

When the canvas is new, the fit will normally be tight. It is designed this way because Sunbrella stretches as it ages. The initial tight fit allows for a suitable fit for the life of the canvas. The Sunbrella fit will vary slightly in the heat, cold, and rain.

SUNBRELLA CANVAS CLEANING

Sunbrella should be cleaned regularly before substances such as dirt, roof particles, etc., are allowed to accumulate on and become embedded in the fabric. The fabric can be cleaned without being removed from the boat. Simply brush off any loose dirt, hose down, and clean with a mild solution of natural soap in lukewarm water. Rinse thoroughly to remove soap. **DO NOT USE DETERGENTS!** Allow to air dry.

For heavily soiled fabric, remove the top from the frame. Soak the fabric in a solution that has been mixed to the following proportions: 1/2 cup of Clorox bleach and 1/4 cup of Ivory or Lux soap (liquid or soap) per each gallon of lukewarm water. Allow the fabric to soak until the bleach has killed the mildew and the stains can be brushed out with a common kitchen scrub brush. Rinse the fabric thoroughly in cold water to remove all the soap. This may require several rinsings. Incomplete rinsing can cause deterioration of sewing threads and prohibit the fabric from being properly retreated. Allow the fabric to dry completely.

Cosmetic Care & Maintenance

DO NOT STEAM PRESS OR DRY IN AN ELECTRIC OR GAS DRYER! Excessive heat can damage and shrink the fabric since it is heat sensitive.

This method of cleaning may remove part of the water and stain repellents that was applied to the fabric during its manufacture. It is recommended to retreat with such water repellency products as Apeal and Uniseal. We do not recommend any wax based treatments such as Thompson's Water Seal or any of the silicone products such as SC-15 or Aqua-Tite. Wax based products prevent the fabric from breathing, and encourage mildew growth while the silicone products interact with the original fluorocarbon finish and seem to cause a rapid loss of water repellency. Scotchguard has not been found to be very effective for restoring water repellents to Sunbrella. It seems to work well in the short run, but doesn't maintain it's performance very long.

CLEAR VINYL, ZIPPER & SNAP CARE

Never store canvas wet or in an unventilated, moist area. Always roll the canvas instead of folding. This is of particular importance on side curtains or any other part with the clear vinyl "glass". Roll the top carefully around the bows and cover with the storage boot provided.

The clear vinyl "glass" used in side curtains, aft curtains, visors, and camper enclosures is very susceptible to heat and cold. Keep vinyl curtains from touching metal tubing to minimize burning the vinyl.

If the boat is stored with top, side curtains and aft curtain in place, heat build up inside the boat may discolor the vinyl.

To clean the clear "vinyl" glass, use a solution of Ivory or Lux soap, liquid or flakes, and lukewarm water. Allow to air dry. Never use any type of abrasive cleaner as it will scratch the "vinyl" glass. There are many cleaners and scratch removers on the market specifically for clear vinyl. Handle the clear curtains carefully. They are soft and prone to scratching.

Canvas parts are designed with zippers. When zippers are new they can be a little difficult to use. Zip carefully without forcing the zipper or the material. They will loosen with use. A zipper lubricant may be used to help new zip-

pers as well as maintaining used ones. The most vulnerable part of the zipper is the starts. Use care when starting the zipper.

Canvas snap fasteners should be unsnapped as close to the button as possible. Never remove canvas by pulling roughly on the edge of the material. This can damage the canvas as well as the fasteners. Use petroleum jelly on snaps to keep them from developing corrosion especially in harsh environments.

METAL

Keep all stainless steel and other metal parts rinsed and wiped dry. To maintain their finish polish the stainless steel and other bright works at least annually. Use commercially available metal products and read the labels carefully before use. Refer to the flyer in the owners information pouch. Most marinas and boating outlets carry metal care products.

HULL BOTTOM

Never use wire brushes or highly abrasive scouring pads on your hull bottom. It could damage the gel coat surface or the bottom paint. The bottom of your boat needs to be clean since the build up of natural coatings from water or marine life can potentially create drag and affect your boat's performance. Contact a marine professional or Regal dealer for more information.

BOTTOM COATING/PAINT

If your hull has been fitted with a bottom coating/paint ensure there is no alga or barnacle growth on the bottom. In salt water areas it may be required to pull the boat and scrape the bottom periodically or divers can accomplish the task.

Touch up any scraped or abraded areas to keep growth from attaching to them. Touch up as required with the appropriate bottom coating per the manufacturer.



FREQUENT STAINS/CLEAN-UP STEPS	1	2	3
Coffee, Tea, Chocolate.....	B		
Permanent Marker*.....	E	B	C
Household Dirt.....	A	B	
Grease.....	D	B	
Ketchup, Tomato Products.....	A	B	
Latex Paint.....	A	B	
Oil Base Paint.....	D	B	
Mustard.....	A	B	C
Suntan Oil.....	A	B	
Asphalt/Road Tar.....	D	B	
Crayon.....	D	B	
Engine Oil.....	B		
Spray Paint.....	B		
Chewing Gum.....	D	A	
Shoe Polish*.....	D	B	
Ballpoint Pen*.....	E	B	A
Lipstick.....	A	B	
Eyeshadow.....	E	B	
Mildew*.....	C	B	A
Wet Leaves *.....	C	B	A

A= Soft brush; warm soapy water/rinse/ dry

B= Fantastik cleaner

C= One tablespoon ammonia, 1/4 cup of hydrogen peroxide, 3/4 cup of warm water/ rinse/dry

D= Scrape off residue (use ice to lift gum)

E= Denatured alcohol/rinse/dry

* These products contain dyes which leave permanent stains.

Cosmetic Care & Maintenance

MAINTENANCE (INTERIOR)

AIR CONDITIONER:

It is a good idea to inspect the thru-hull fitting for leaks before each outing and to make sure the seacock is open. Also, the sea water strainer located in the bilge should be checked periodically for foreign objects clogging the strainer. To clean the strainer, unscrew the seacock fasteners, remove the wire strainer, and blow it out if possible with compressed air. Reinstall the strainer, making sure the gasket or “O” ring on the top of the seacock is centered. Then tighten the fasteners. Check for leaks since sucking air into the system could cause the seawater pump to malfunction. See the equipment operation chapter for more information.

Check the A/C hose output located on the hull side. Make sure there is a full discharge when the A/C pump is running. If there is little or no discharge shut down the unit immediately and troubleshoot the cause of the problem.

AIR FILTER REPLACEMENT

The AC filter should be checked monthly. If dirty hose off the filter. Air dry.

Replace the air filter per A/C manufacturer recommendations. If periodic maintenance is not performed the unit could shut down from lack of air or from an icing condition. Follow the steps below:



1. Remove the filter from the air conditioner unit. Simply pull up on the filter to release it from the unit.
2. Replace with the exact replacement size. See your Regal dealer for further information.
3. Make sure the new filter is correctly positioned.

 **WARNING**

PREVENT BODILY INJURY OR DEATH!
DISCONNECT THE A/C BREAKER AT THE
MAIN A/C PANEL BEFORE OPENING ANY
COVER ON THE A/C UNIT.

 **WARNING**

PREVENT BODILY INJURY OR DEATH!
DO NOT LOOSEN OR REMOVE ANY FITTINGS
DUE TO THE HIGHLY PRESSURIZED
REFRIGERANT FOUND IN THE AIR
CONDITIONER UNIT.



DRAIN TRAY & TUBE CLEANING

There is a drain tray located under the AC unit. A drain is located at the lowest point of the tray. A hose exits moisture overboard via a shower type box with a float switch as the AC unit is being used. It is recommended that the tray & drain-hose be cleaned every 50 hours.

The best way to accomplish this is to buy condensation drain tablets. Put one on the tray and it will dissolve and clean the drain and hose as part of the normal AC cycle. As the unit is used it will continue to purge moisture from the air. Most box stores carry these tablets. A mixture of bleach & water is not recommended for cleaning since it may attack the finish of the tray being bleach can be highly corrosive.

CONDENSOR COIL CLEANING (AS NEEDED)

1. Turn the AC system off at the ship's main electrical panel. Disconnect the inlet and outlet connections on the condenser coil.
2. Use chemical resistant hoses (MAS white PVC 5/8" I.D., etc) to connect the inlet of the condenser coil to the outlet of the chemical resistant pump and let the hose connected to the coil outlet flow freely into the container mentioned below.
3. Place a strainer or piece of screen over the inlet of the pump and submerge the pump into a container with a 5% solution of muriatic or hydrochloric acid and fresh water or use a pre-mixed over the counter solution. Use as large a container as possible to hold the solution (5-25 gallons).

 **CAUTION**

**AVOID BODILY INJURY!
AVOID SPILLING OR SPLASHING THE
SOLUTION. FOLLOW ALL WARNINGS
AND RECOMMENDATIONS GIVEN BY THE
MANUFACTURER OF ANY ACIDS OR
PREMIXED SOLUTIONS.**

4. Power the pump and circulate the solution through the condenser coil for 15-45 minutes depending on the size of the coils and the extent of the contamination. Visual inspection of the solution in the container should indicate when the contamination removal has stopped.
5. Circulate fresh water through the coil to flush any residual acid from the system.
6. Restart the system and check operational parameters to ensure a through cleaning has taken place. You may want to contact your closest Regal dealer or marine professional to perform this procedure.

Cosmetic Care & Maintenance

NOTICE

FOR THE PURPOSES OF PROTECTING THE ENVIRONMENT, DISPOSE OF ANY CONTAMINATED ACID SOLUTIONS IN ACCORDANCE WITH FEDERAL, STATE AND/OR LOCAL REGULATIONS.

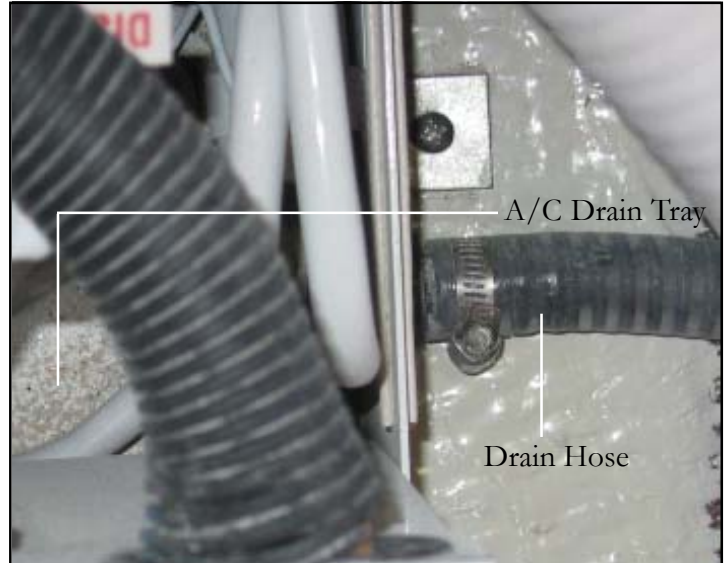

OTHER CHECKS

Check all related hoses for kinks, looping or excessive wear.

Also, when the boat is lifted for dry storage or for service check the AC inlet for debris.

REVERSING VALVES

Reverse cycle units have reversing valves; the valve must be energized periodically to keep the internal parts moving freely. To do this, switch the air conditioner into heat cycle for a few seconds each month.



CARBON MONOXIDE DETECTORS

We strongly recommend that you fully acquaint yourself with the total operation of the carbon monoxide detector since it does measure accumulated levels of CO. Normal maintenance should include frequent checking including the green power light glowing with the warning indicator and audible horn off.

Each detector should be returned to the manufacturer each year for recertification. Refer to the owner's document box for more information.

The CO detectors are normally located in the berth areas of the vessel.

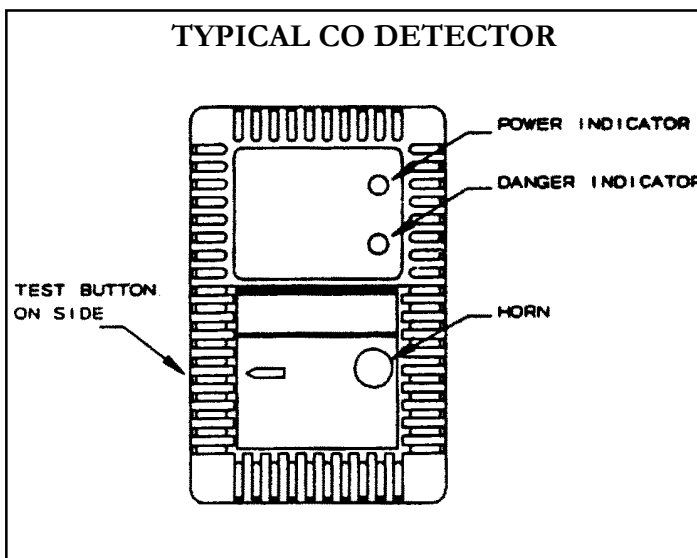

SHOWER SUMP PUMP (TYPICAL)



The shower sump pump shown above is used to collect used water waste from the sinks or the shower itself. After the liquid reaches a designated height, the sump pump energizes through a float switch and exits waste to a manifold then overboard. Periodically check the sump pump grate for debris such as hair and soap build up. Check to make sure the automatic float operates freely at all times. Also, clean out the box with a bleach/water solution as needed to kill bacteria. You can back flush using the bleach/water procedure.

Cosmetic Care & Maintenance

ELECTRIC TOILET

Periodic maintenance is normally not essential other than cleaning and lubricating with the approved brand toilet cleaner and conditioner which can be ordered from your Regal dealer, marine outlet store or on the internet.

Before performing any service, flush the toilet long enough to ensure all waste is emptied from the discharge hose. Close both inlet and discharge (if applicable) seacocks and put a placard on each to guard against accidental opening and flooding while service is being performed.

Check your toilet owner's paperwork for information on available repair kits, parts lists and service procedures.

OVERBOARD DISCHARGE PUMP

Periodically check all clamps and fittings for tightness. If pump access is required, make sure power to the pump is turned off. Place a collector tray underneath the pump inlet and outlet hoses. Wear rubber gloves to protect yourself. If subjected to freezing climates, winterize the toilet system properly. It is best to leave the system completely drained and dry for extended decommissioning periods.

Troubleshooting tips:

1. Pump operates but no waste is being pumped.
 - a. Check that all connections are airtight and secure.
 - b. The seacock is open. The handle should be in-line with the fitting *not at 90 degrees to it*.
 - c. Clamping ring screws are tight and diaphragm is fitted correctly.
 - d. Diaphragm is in working order.
2. Pump will not operate.
 - a. Check fuse. Always figure out why the fuse blew before replacing it. Normally it is a case of a closed seacock or blocked lines.
 - b. Check electrical connections at the key switch on the monitor panel and the pump. Normally 12 volts should be present at the "on" and "start" key switch positions. In the start position 12 volts should be present at the pump. Use a volt meter or test light to perform the above checks.
 - c. Pump malfunctioning. Contact a Regal dealer.

NOTICE

KEEP MANUFACTURER'S RECOMMENDED
PUMP SPARE PARTS ON BOARD.
THIS MAY INCLUDE DIAPHRAGMS AND IN-
LINE FLAPPER VLAVES.
CONTACT A REGAL DEALER.



FRESH WATER SYSTEM

The fresh water system in general requires very little maintenance.

1. See the equipment operation chapter defining the recommended seasonal disinfection procedure.
2. The fresh water filter needs to be cleaned periodically. Simply remove the hose clamp and unscrew the fresh water filter to access the screen. Rinse the screen off to remove any foreign debris. Be sure to use teflon tape on the pump fitting threads before installing the filter. Reinstall the components and check for leaks. See the illustration.
3. Periodically check all fittings for leaks.
4. In colder climates, use Winterban or its equivalent in all the fresh water system components after draining the system.

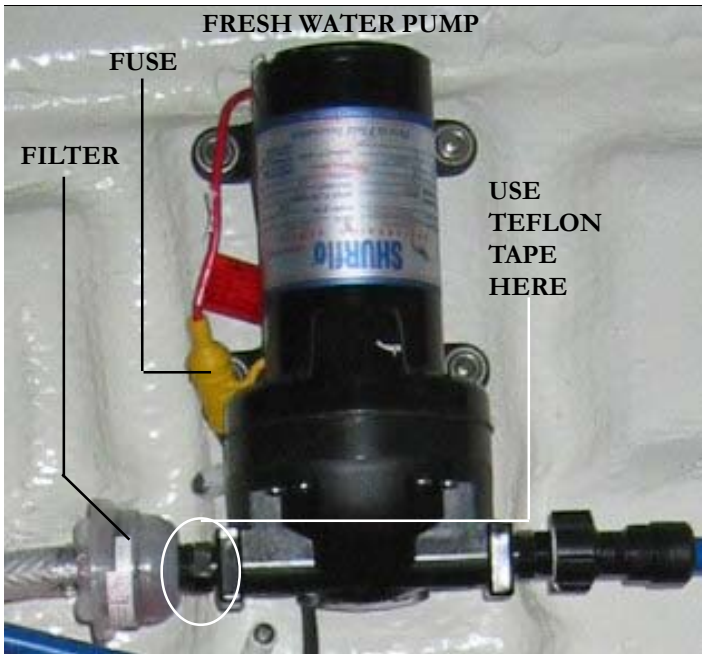

HOT WATER HEATER

A. The most important maintenance factor with the hot water heater is it should be treated with Winterban in colder climates. Use the water heater drain valve to vacate water from the tank. The water will automatically drain into the shower sump pump and then will be sent overboard. Make sure the water heater breaker is turned off before any winterization is started to prevent the element from being burned out.

B. If the system is constantly being used in warmer climates it is a good idea to periodically drain the hot water valve for 30 seconds or so to eliminate any scale that has built up inside the hot water heater. Turn the breaker off just as a precaution.

C. The hot water heater and heat exchanger parts are made of aluminum. If engine flushing is required by the manufacturer be sure to disconnect the heat exchanger from the system temporarily. The caustic chemicals will damage the hot water heater aluminum parts. Re-plumb the heat exchanger after engine flushing.

D. Test the T&P valve periodically to make sure it works properly. Its purpose is to let off excess water vapor (steam) if the thermostat should stick and a critical temperature situation develops within the tank. With the water heater at operating temperature (use gloves) pull on the valve trigger top and raise the trigger to 90 degrees to test it. The water will vacate to the shower sump pump.

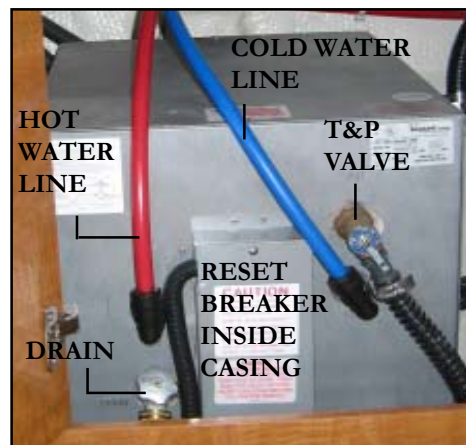

Cosmetic Care & Maintenance

E. The heater is equipped with a high temperature limit switch which can be manually reset. If the limit switch activates, do the following:

1. Turn the power off at the main cabin AC panel.
2. Remove the remote switch access cover.
3. Depress the red button on the high temperature limit switch.
4. Replace cover and activate the main cabin water heater switch.
5. If the temperature switch reactivates, contact your Regal dealer.

FRESH WATER PLUMBING

A majority of the plumbing is located under the head and galley sinks for easier maintenance. This includes hot and cold water lines and various connectors. Cold water lines are blue and hot water lines are red. Periodic inspection of these areas is recommended.



Head Sink Plumbing

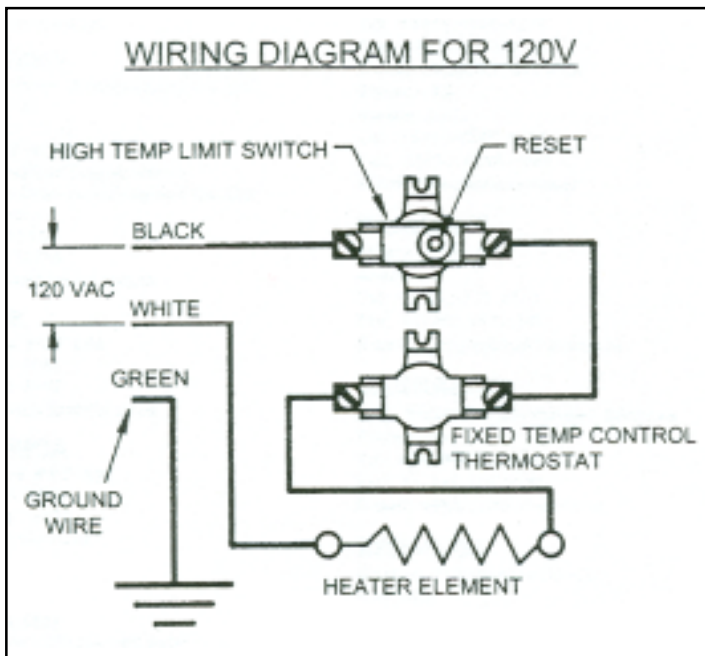



PLUMBING CONNECTORS

All black plumbing connections to the red and blue fresh water lines require special instructions when they are to be removed or replaced. Be sure to turn off the water before starting any plumbing repairs.

1. To remove a tee, 90 degree, or straight fitting first undo the cap on the end of the fitting by using a slotted screwdriver. Insert the screwdriver in the cap slot and turn 90 degrees. Cap will release from the fitting.



2. Push the connector and collar together. Hold the collar next to the connector with your finger. Pull and the connector/collar will release itself from the water line.

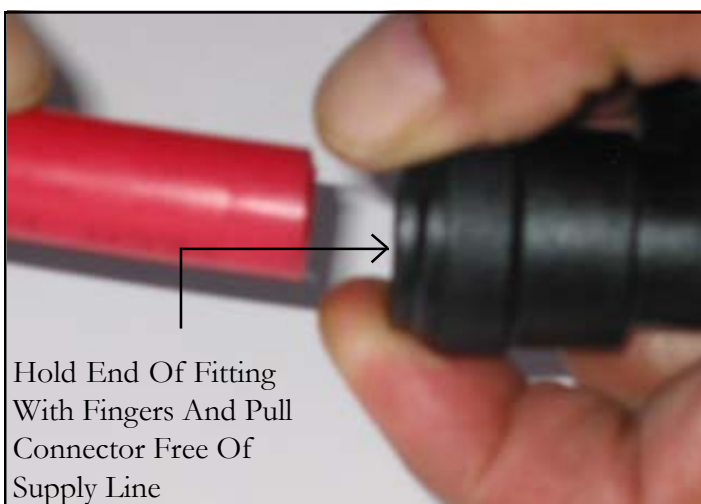

To reinstall a plumbing connection to a water line make sure the line is cut off square and the end is smooth. This will aid in ensuring a leakproof connection.

1. Install the cap on the supply line. You may need to use a slotted screwdriver to remove the cap from a new fitting.

2. Simply push the fitting on to the supply line until pressure is felt. This ensures it is completely in the fitting.

3. Push the cap on the collar until it snaps in place. Turn on the water pressure and check for leaks.

Note: With the connector in place, a small movement between the line and connector is normal.

Cosmetic Care & Maintenance

GALVANIC ISOLATOR & BONDING SYSTEM MONITOR

1. The ground wire and galvanic isolator monitor is self-testing. To ensure it is operating correctly, press the “test” button and monitor its activity.

During the self-test process all four LED’s will light in this order:

Ground wire normal

Ground wire fail

Galvanic isolator normal

Galvanic isolator fail

Then it will pause and light again galvanic isolator fail. When the fail lights up on each component check you will also hear an audible alarm. If the LED’s do not light in this order or the alarm does not sound, the unit has failed its self-test and should be replaced.

2. Periodically, check the wire connections to ensure they are clean and tight.

DVD PLAYER/TELEVISION

Since most of the same cleaning and maintenance tips overlap on these entertainment components, they will be grouped together.

1. To clean the slots in stereos, DVD players use a dry or slightly water moistened swab to remove any buildup of debris. This monthly procedure will assist in preventing the discs from being scratched.

2. To clean the faceplates of the various units use a dry soft cloth. If the faceplate is stained badly, use a moist cloth with a neutral cleaner. Do not use harsh, caustic or alcohol based chemicals to keep the letters from coming off the faceplate. Do not use silicone spray or WD-40 since they could damage mechanical parts.

3. If these units will not play discs properly they may have developed condensation. Wait 1 hour and retry.

4. Keep all remote controls out of extreme heat and high moisture environments. Change batteries often for best operation.

5. Periodically check all discs for scratched and dirty surfaces. Clean the dirty ones with a cleaning kit which can be purchased at most electronic stores.

6. With flat screen televisions, do not attempt to service the unit yourself since high voltage exists.

7. To clean the flat screen display, dampen a soft cloth with water or a mild detergent. The best cleaner is a screen cleaning tissue specifically designed for antistatic coating. Never use flammable cleaning materials or glass cleaners with ammonia since they may attack the television screen surface.



SALON REFRIGERATOR

The cabin refrigerator periodically requires the compressor coils to be cleaned off. To accomplish this task, make sure the refrigerator circuit breaker is off and all food cleared out. You need to remove the 4 screws inserted in the outside trim of the refrigerator. Once all the screws are out, you will be able to access the coils at the rear of the unit by pulling it out of the cavity. You should be able to disconnect the plug at this point. Set the unit on a stool to clean the coils using a soft brush. Reinstall.

A good time to clean the inside of the refrigerator is just after defrosting the unit. Once it is to room temperature, clean all surfaces and trays with a soft cloth and mild cleaner. This will help remove any odors. After the unit is plugged back in insert a small box of baking powder to help remove any odors produced by future stored food. When leaving the boat for extended periods make sure the circuit breaker is off, all material is removed from the refrigerator and the door is wedged open.

CABIN ENTRY DOOR TRACK

Periodically clean the cabin door track by using a vacuum with an upholstery nozzle. Then wipe off any residue with a damp cloth and warm water. Do not spray the door track with silicone spray, oil or type A lubricant since a slippery surface could produce a fall.



FLOORS

To maintain wood floors clean with a mild detergent. Do not use any heavy abrasive cleaners since they could scratch and subsequently damage the finish coat. Also, do not use bleach, ammonia or acid type products. Above all follow floor manufacturer product care guidelines.

GFCI DUPLEX RECEPTACLE



Ground fault outlets must be tested monthly. To test, depress the reset button. Next, press the test button. The reset button should pop out. If it does not, contact a qualified electrician or marine professional.

Since all receptacles are connected through the GFCI circuit they should show zero voltage when the GFCI test button is pressed. A

plug-in type tester can be obtained at most hardware stores for testing outlets. Corrosion is your worst enemy with the GFCI duplex especially in high humidity environments.

Cosmetic Care & Maintenance

WINDSHIELD WIPER MOTOR ACCESS

At the salon headliner (called whisper wall) there is an access cover. Inside is the windshield wiper motor and wiring connections. Periodically check the connectors for tightness.





MAINTENANCE (EXTERIOR)

WINDLASS

To maintain the windlass in salt water environments spray off the outside casting with fresh water along with the chain, thimble and shackle parts. Also, make sure you spray off the gypsy area where the chain travels through. This prevents corrosion build up. The manufacturer recommends that the gypsy and drum be disassembled at least once a year to clean and lubricate the unit. Spray external parts with CRC or WD40.

Make sure the gear housing is not leaking oil. Fill as needed with correct weight gear oil. Replace any leaking seals.

Check all solenoid terminals for tightness. These parts may be behind the forward deck locker in a protective box. Refer to the windlass maintenance manual for more information.

TRIM TABS

Trim refers to the running angle of the boat while underway to achieve the most efficient planning angle. Check all electrical connections for tightness, corrosion, and chafing. All mechanical trim tab components should be checked periodically. If a malfunctioning tab is suspected, run each tab in and out while someone looks at each tab to make sure it is moving up and down the proper distance. **Replace zinc anodes when at one half their life as determined by size. Check anodes twice a month.**

Check the fluid in the hydraulic power unit (HPU) to make sure it is at the proper level. The pump is located in the bilge close to the transom. To refill, remove the lexan cover and filler plug. Fill with any type automatic transmission fluid (ATF). The fluid level should be 2" from the reservoir bottom.

The trim tabs may be painted for corrosion protection. **Do not paint the anodes.** Refer to the owner's document box for more information.

 **CAUTION**

**PREVENT BODILY INJURY!
REMOVE THE CHAIN FROM WINDLASS
BEFORE PERFORMING MAINTENANCE.**

FIRE EXTINGUISHING SYSTEM

The fire extinguisher system canister located in the sump should be checked to make sure the hold down brackets are tight. The canister features a gauge that displays the level of agent left. The gauge should show a level in the green area. Any reading in the red area needs immediate attention or replacement. The dash monitor switch should show a green light indicating systems are operational.

SPOTLIGHT

The spotlight lens should be wiped with a clean, dry, soft cloth to remove any debris such as bugs, salt spray or general dirt. Read the manufacturer's literature for more information.

DECK HARDWARE

Inspect all mounted hardware often for tightness and deteriorated fasteners. Pay extra close attention to cleats and eyes since they are often under huge loads

COCKPIT CARPET

Avoid cleaning carpet with harsh liquids or abrasives. Clean carpet stains with a well recognized product such as Resolve. Test an area before using the product. Follow the directions on the label. Use a terry towel in combination with the cleaner to remove stains. Avoid over wetting the carpet. When storing cockpit carpet make sure that it is completely dry and then roll each piece rather than fold it.

Cosmetic Care & Maintenance

REMOTE CONTROL

The remote control at the dash control box and the cable attachment at the engine should be tight and shift without binding.

Shift and throttle controls at both the engine and helm areas must be checked on a periodic basis. At the engine end, make sure all control cable hardware is tight and control cable brackets are secure. An application of silicone spray on the cable ends periodically will keep control cables working freely and inhibit corrosion. At the helm end check the control box hardware for tightness.

GAS VAPOR DETECTOR

This item requires little maintenance. The dash light monitors the operation of the device. The sensor unit is located in the bilge area so be careful not to step on it.

COMPASS

The compass should light when the navigation switch is activated. Clean the dome with a soft cotton cloth or chamois dipped in fresh water and a mild detergent. Do not use abrasive cleaners or strong solvents as these will scratch or fog the dome. A soft non-abrasive wax can be used to protect the dome after cleaning. To protect the compass from excessive sunlight, the protective hood should be closed when the compass is not in use.

If the vessel is left for extended periods of time like over the winter remove the compass and store it at room temperature.

After handling or cleaning the compass the card may appear to dip due to static electricity. This is a normal.

HORN



The horn is located at the starboard deck. It features a chrome grill. To adjust the horn sound you simply unloosen the nut and adjust the screw

slowly to achieve the highest DB level possible while someone holds the horn button at the helm.

HATCHES/ PORTLIGHTS

Your boat uses the finest hatches and portlights available. To care for the lens wash with mild soap and lukewarm water. Polish with a mild automotive type product. Scratches may be removed or minimized by using a mild automobile polish like Johnson's Paste Wax or Mirro Glaze Plastic Polish. Silicone spray is recommended to keep moving parts clean from salt build-up.



ELECTRONICS

Avoid using any abrasive type cleaners on the main body or the screen surface of the equipment. This would include ammonia, alcohol based chemicals such as mineral spirits, acetone, and acid products. Wipe with a soft rag to avoid scratching surfaces.

As with any electronic equipment, do not use a hard direct spray from a hose nozzle. Keep the cover on when not in use. Below are a few general notes on your electronics. The electronic equipment manuals should be read individually for specific maintenance information.

The chartplotter is a sealed unit. Check the following periodically:

1. Examine cables for signs of wear, corrosion, cuts or nicks.
2. Check to see that all connections are tight and the vessel DC connection is secure and corrosion free.
3. Check the cartridge cover for correct fit.
4. Refer to the troubleshooting information as needed.

 **WARNING**

**AVOID BODILY INJURY!
THE CHARTPLOTTER CONTAINS HIGH
VOLTAGE AND CIRCUITRY ONLY
ACCESSIBLE TO QUALIFIED SERVICE
TECHNICIANS. DO NOT REMOVE
THE REAR COVER AS A SHOCK
HAZARD EXISTS!**

TYPICAL COCKPIT REFRIGERATOR

If equipped the cockpit refrigerator is located across from the helm seat. It features a pull-out drawer style door that lends itself to cockpit entertainment. The refrigerator tray is completely removable for cleaning and cools up to a case of beverages and foods within easy reach. To remove the tray pull it completely forward and lift the rear of the tray from the rollers.

The thermostat is located at the starboard forward side of the unit. To activate turn clockwise to the desired position. As with most thermostats give the refrigerator awhile to adjust itself to a change in the thermostat setting.



Cosmetic Care & Maintenance

BATTERIES

Frequently check your battery terminals for corrosion build-up. If you find a greenish, powdery substance, remove the cable connections and clean both the terminals and the connectors with a wire brush. When the cleaning is finished reconnect the battery cables and coat the

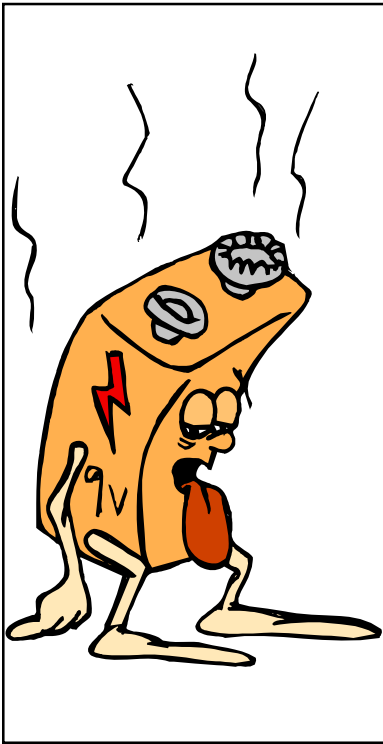

terminals with with a petroleum jelly to help prevent any further corrosion. Check the electrolyte level at least every 30 days, more often in hot weather. The level should be maintained between the top of the battery plates and the bottom of the fill cap opening. Add *distilled* water (does not contain minerals) as needed after charging the batteries or as needed. Do not overfill because sulfuric acid could run over and cause burns or an explosion. Extremely corroded batteries can

be cleaned with baking soda and rinsed with warm water. Perform this procedure with the batteries removed from the boat.

Batteries should be charged outside the boat. Do not smoke or bring flames near a battery that is being or has recently been charged. The hydrogen gas generated by battery charging is highly explosive.

Set cranking batteries on a block of wood rather than concrete since this procedure will aid the batteries to hold their charge.

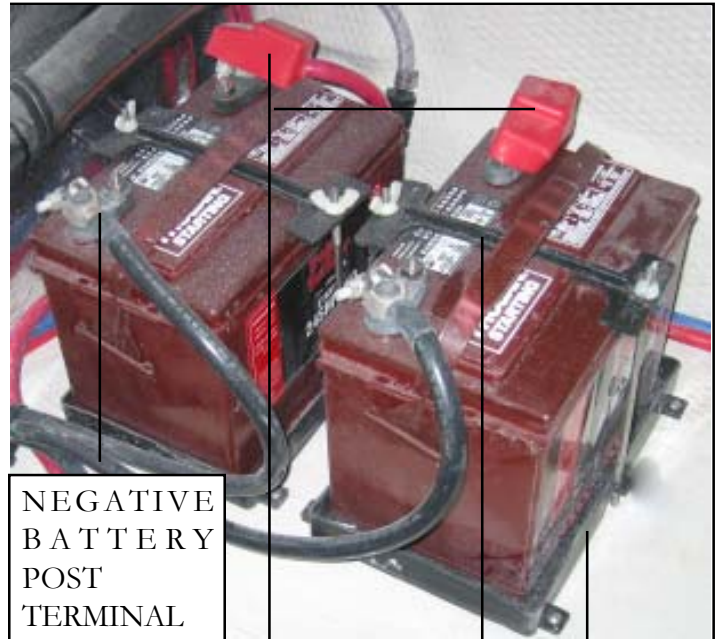

POSITIVE BATTERY BOOTS

TIE-DOWN HARDWARE

BATTERY TRAY

Do not allow a metal object or loose wires to spark across battery posts while working close to the battery. Contact across the terminals will cause a short circuit and electrical fires or personal injury may result.

Tighten all battery tie-down and battery tray fasteners securely. Check their tightness by pulling on the connectors. They should not move from their tightened position. When the battery is yanked on it should not move more than 1" in any direction. Be sure to reinstall the positive boot over the battery terminal after tightening the battery post connection. Monitor the charge with the engine turned off (static condition).

The engine alternators recharge the batteries. A fully charged battery will indicate between 12.3 and 12.6 volts on the voltmeter. Readings below this could indicate a dead battery cell or a charging system malfunction which should be checked by a marine professional.



WARNING

PREVENT BODILY INJURY!
WEAR GOGGLES, RUBBER GLOVES
AND A PROTECTIVE APRON
WHEN WORKING WITH A BATTERY.
BATTERY ELECTROLYTE CAUSES SEVERE
EYE DAMAGE AND SKIN BURNS.
IN CASE OF SPILLAGE,
WASH AREA WITH A SOLUTION
OF BAKING SODA AND WATER.



WARNING

PREVENT BODILY INJURY!
BATTERIES CONTAIN SULFURIC ACID
(POISON)
WHICH ALSO CAN CAUSE BURNS.
AVOID CONTACT WITH THE SKIN,
EYES & CLOTHING.
IF CONTACTED, FLUSH WITH WATER AT
LEAST 15 MINUTES. IF SWALLOWED, DRINK
LARGE AMOUNTS OF WATER OR MILK.
FOLLOW UP WITH MILK OF MAGNESIA,
BEATEN EGG OR VEGETABLE OIL.
GET MEDICAL ATTENTION IMMEDIATELY!

Cosmetic Care & Maintenance

BILGE PUMP/AUTOMATIC FLOAT SWITCH

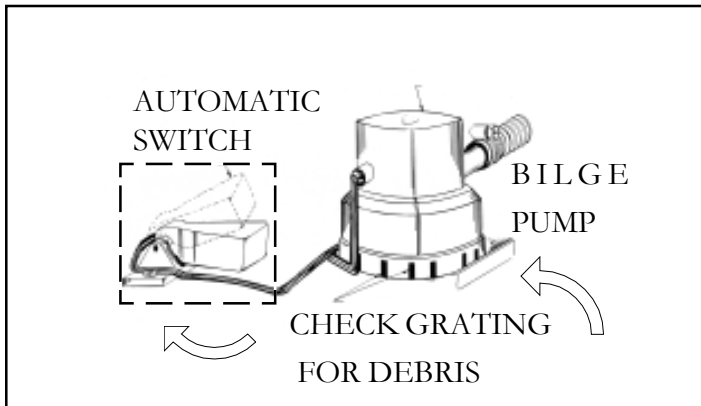

Look for foreign materials in the strainer area or discharge hose and remove as necessary. Inspect all clamps and electrical connections for tightness. A quick check of the bilge pump automatic float switch is afforded by lifting up on the float located in the sump and listening for the pump operation.

BLOWER

Check the blower hoses to ensure they are fastened in the bilge properly and there are no holes in them. The hose connected to the blower needs to be 3/4 the way down in the bilge to evacuate fumes properly. Ensure there are no hose traps that can hold water. All vents need to be checked for debris. Make sure the blower motor is securely fastened and all hose clamps, tie wraps and electrical connections are tight.

FUEL TANK & FITTINGS

Periodically inspect the fuel tank components for loose clamps at the vent, fill and feed locations. Examine each hose for signs of deterioration and leakage. Check the fuel sender for loose bolts, nuts, and leaks at all areas of contact. Also, inspect the fuel tank for signs of leakage or abrasion. Tighten all components as needed.

Never remove the spring and ball assembly in the anti-siphon valve. It can be cleaned with compressed air. Should the component be faulty (normally a fuel surge problem at mid to high speed ranges) contact a marine professional to replace it. Check the fuel fill pipe hose connection at the deck using the access plate which can be removed for inspection. Make sure the black ground wire is tightly secured. For further information, contact your closest Regal dealer.

TYPICAL FUEL TANK FITTINGS

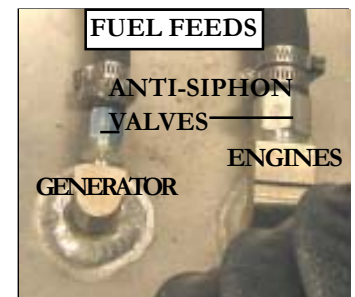
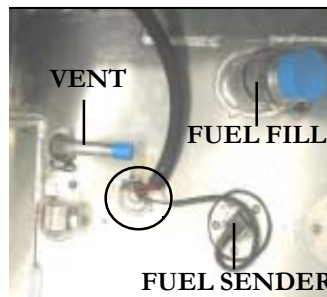

Note: Select later fuel systems distributed domestically include EPA components. This system uses a different configuration on fuel tanks and fuel distribution hardware to comply with EPA legislation dated July, 2012. Therefore the parts in the EPA fuel system may vary in function and appearance from earlier fuel systems.



FRESH WATER TANK

The fresh water tank is located in the sump area. Be sure to clean and rinse the tank periodically with a bleach and water solution. See the chapter on systems for more information. Winterize the water tank and fresh water system in colder climates as necessary.

OVERBOARD DISCHARGE PUMP

If your boat is equipped with an overboard discharge pump pay close attention to what materials are flushed through the waste system as it could become clogged. Do not pump garbage, rags, or sanitary napkins through the overboard discharge pump (macerator). Flush the waste tank and pump with fresh water with each pump out. Do not run the pump dry or for extended periods of time since the impeller can be damaged. Pump the waste system out at decommissioning time and rinse fresh water through the entire system.

Cosmetic Care & Maintenance

PROPULSION MAINTENANCE

ENGINE

Each engine package is unique and quite complex. A select portion of the maintenance items are covered in this chapter. Many times because of the advanced ignition and fuel injection systems used on marine engines it is best to use trained marine professionals. For more detailed information, refer to the manufacturer's engine owner's manual or call your closest Regal dealer.

STERN DRIVE

The stern drive unit should be checked before each outing. Tilt the drive unit up and check for any debris around the intake or wrapped around the propeller or shaft. Check your engine manual for specific drive maintenance schedules.

PROPELLERS

Out-of-balance or nicked props will effect performance or cause vibration. Damaged props should be replaced, but those that are chipped or bent can usually be reconditioned by a propeller repair facility. When cruising, Regal recommends you carry a spare set of props on board because many marinas do not offer a full inventory of replacement propellers. Refer to the manufacturer's engine manual for appropriate stern drive propeller replacement and correct installation procedures.

Be sure to make a note of the propeller diameter and pitch while the vessel is in dry dock. They are normally pressed into the prop for easy reading.

If you feel vibration the propeller(s) may be damaged. Turn the engine off, raise the drive and inspect for damage. If the vessel revs up but does not gain proper speed moving forward a propeller hub may of spun out. This requires replacing the propeller.

VOLVO PROPELLER REMOVAL

Make sure the ignition keys are in the "OFF" position along with the battery switch.

It is recommended that you wear a pair of leather gloves to protect yourself from sharp propeller blades. With **dual** propeller units you may be able to use a piece of wood between the top of the gear housing and the propeller to hold it from turning while you are removing the prop nuts and hardware to access the props. Some of these units use 2 lock nuts, one for each propeller. You may need a special socket and ratchet set to remove the propeller nuts. Line up the hardware according to its disassembly for reassembly purposes. Below are drawings showing selected propeller shaft hardware for both Volvo and Mercruiser units. See the engine manufacturer's owners manual for further information.

VOLVO DUO PROP INSTALLATION

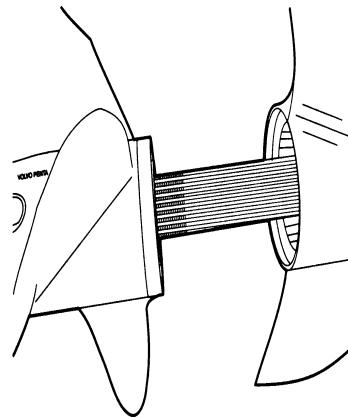

Coat both shafts with marine grease. Place the remote control in forward position to lock shafts. Install the front propeller.

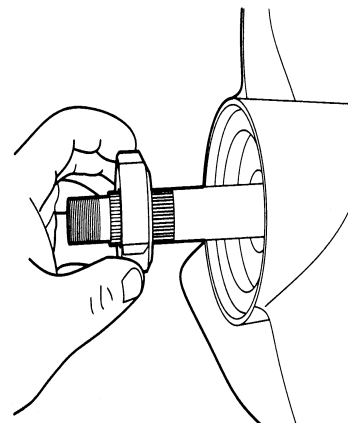

Install propeller nut. Tighten to 45 ft. lbs. (Use torque wrench) Make sure the chamfered edge of the prop nut is facing forward. Failure to install prop nut correctly could result in loss of prop or damage to lower unit.



MERCURISER BRAVO THREE

STEERING

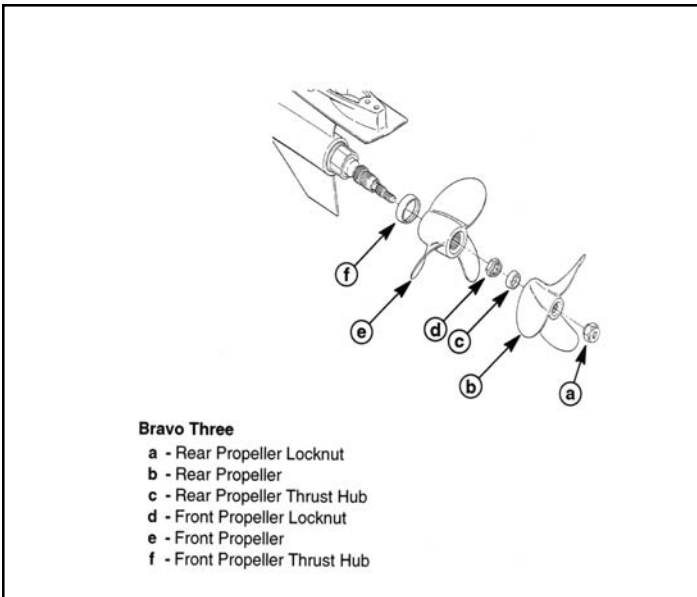

Regals feature rack or rotary style steering systems that utilize a cable with assistance through the engine power steering pump. As you turn the steering wheel force is applied through the system to a hydraulic cylinder attached at the engine rear and connected through the engine power steering pump hoses.

With the engine running, check the engine power steering pump levels before each outing. Add the appropriate power steering fluid. Periodically inspect the entire steering system for tightness and signs of wear and leaks including the steering wheel. Lubricate the steering shaft at the engine. Refer to the manufacturer's engine manual in the owner's document pouch for additional information along with the maintenance chart in this chapter.



CAUTION

AVOID PERSONAL INJURY AND
PROPERTY DAMAGE!
LOOSENING OR LOSS OF ONE
OR MORE FASTENERS MAY CAUSE FAILURE
OF THE STEERING SYSTEM OR DAMAGE
TO THE STEERING CABLE
RESULTING IN LOSS
OF STEERING CONTROL.
PERIODICALLY INSPECT THE STEERING
SYSTEM.

Cosmetic Care & Maintenance

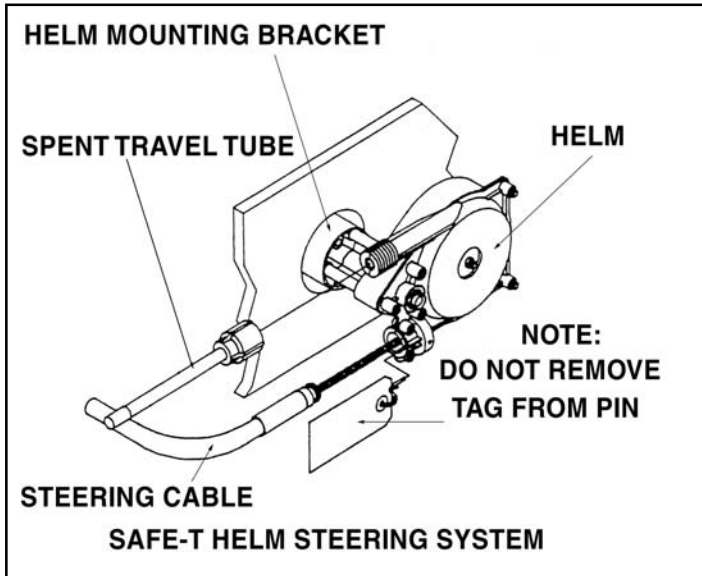

ELECTROLYSIS PROTECTION

Sacrificial zinc anodes usually found on the outdrive housing, trim cylinders or propshaft are used to protect softer metals exposed to the water. Electrolysis attacks the least noble metals first. Because zinc is a less noble metal, it will decompose before other metals. Check these zinc anodes periodically and have them replaced when they are one third gone.



CAUTION

AVOID INJURY AND PROPERTY DAMAGE!
ABRUPT TURNS ABOVE 30 MPH
MAY RESULT IN LOSS OF CONTROL.
STEERING RESPONSE AT HIGH SPEEDS
CAN BE VERY SUDDEN.
ABRUPT TURNS MAY CAUSE YOU
TO CROSS YOUR OWN WAKE.
JUMPING A WAKE, SUDDEN TURNS, AND
INCREASES OR DECREASES IN SPEEDS
MAY BE DANGEROUS.
THE OPERATOR MUST ENSURE THAT ALL
PASSENGERS ARE SEATED SECURELY
BEFORE MAKING SPEED CHANGES.



CAUTION

AVOID PERSONAL INJURY AND PROPERTY DAMAGE!
 ABRUPT TURNS ABOVE 30 M.P.H. MAY RESULT IN LOSS OF CONTROL. STEERING RESPONSE AT HIGH SPEEDS CAN BE VERY SUDDEN.
 ABRUPT TURNS MAY CAUSE YOU TO CROSS YOUR OWN WAKE.
 JUMPING A WAKE, SUDDEN TURNS, AND INCREASES OR DECREASES IN SPEEDS MAY BE DANGEROUS.
 OPERATOR MUST MAKE SURE THAT ALL PASSENGERS ARE SEATED SECURELY BEFORE MAKING SPEED CHANGES.

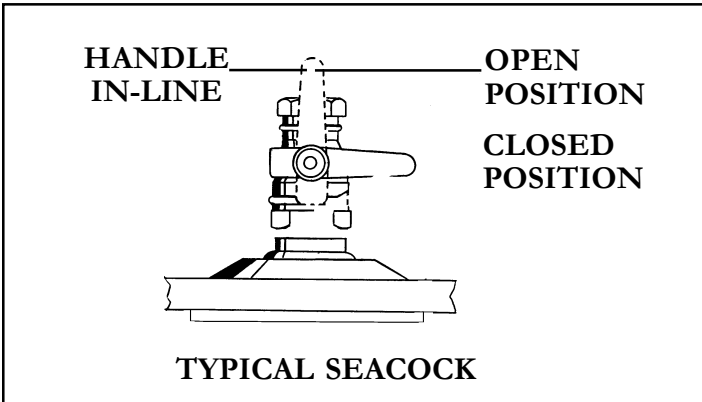

SEACOCKS

Inspect the thru-hull seacocks before and after each outing. Make sure the connections between the hose and the valve are tight. Look for water leaks around the area where the valve and hull meet.
 Every 30 days open and close each thru-hull valve several times. This will guard against the valve seizing in the open or closed position. While doing this make sure the valve handle is tightly fastened. Ensure that all seacocks are closed upon leaving the vessel.

TYPICAL SEA WATER STRAINER

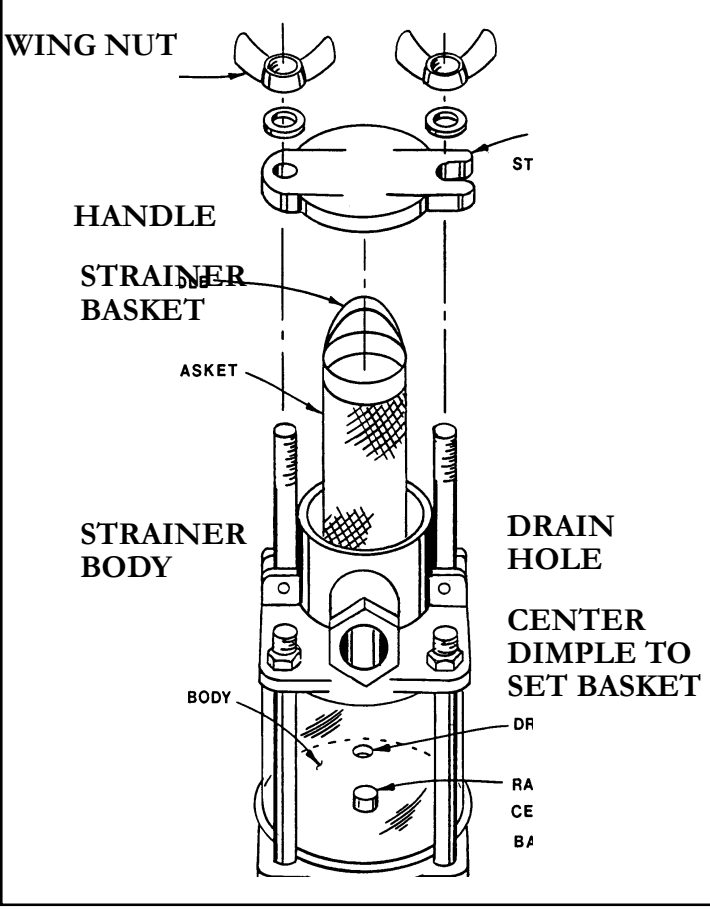

Before servicing the sea water strainer make sure the appropriate seacock has been closed to prevent water from entering the boat. If possible blow out the strainer basket with compressed air or use a metal type brush to remove any material from the screening material. Make sure the strainer is aligned in the center dimple on reinstallation.
 Check all parts for wear and possible leaks including any gasket surfaces. Do not overtighten the strainer wing nuts as this could cause strainer body and or gasket damage. Use original replacement marine parts only. After all parts are reassembled open the seacock and check for leaks. Notice the drain hole in the bottom of the strainer body. Take the appropriate steps to ensure the strainer is winterized properly in colder climates.

Cosmetic Care & Maintenance

MAINTENANCE SCHEDULE

This maintenance schedule chart provides only general guidelines. Be sure to check specific areas periodically. Priority guidelines are listed by type.

Type A-maintenance after each use.

Type B-maintenance checks periodically.

Type C-maintenance performed after 25 hours of operation.

Type D- maintenance performed every 6 months /100 hours of operation.

COMPONENT/SYSTEM	TYPE A	TYPE B	TYPE C	TYPE D
Engine Compartment				
Maintenance Per Engine Manual				
Inspect Water Hoses	X	X	X	X
Check Propeller For Nicks				X
Inspect Thru-Hulls For Leaks	X	X	X	X
Inspect Seacocks For Leaks	X	X	X	X
Check Exhaust For Leaks	X	X	X	X
Check Trim Reservoir Levels	X	X		X
Check Engine Oil	X	X	X	X
Check Outdrive Oil	X	X	X	X
Check Power Steering Fluid	X	X	X	X



COMPONENT/SYSTEM	TYPE A	TYPE B	TYPE C	TYPE D
Remote Control System				
Check Throttle/Shift Adjustment		X	X	X
Test Neutral Safety Switch		X		X
Lubricate Control Cables				X
Lubricate Remote Control Box				X
Lubricate Shift Cable (I/O)				X
Check Control Box Fasteners		X		X
Steering System				
Check Steering Cable Helm Nut		X		X
Inspect Steering Cable For Cracks		X	X	X
Lubricate Components		X		X
Check Steering Wheel Nut		X		X
Electrical System				
Inspect/Clean Battery		X		X
Check 12 volt wiring connections		X		X
Fuel System				
Clean Engine Fuel Filters		X	X	X
Check Hoses/Chafing & Leaks	X	X	X	X
Check Static Ground Wire At Fill				X

Cosmetic Care & Maintenance

COMPONENT/SYSTEM	TYPE A	TYPE B	TYPE C	TYPE D
Fresh Water & Waste System				
Flush Entire System & Tank				X
Clean Pressure Pump Filter		X		X
Inspect System For Leaks		X		X
Sanitize Waste System		X		X
Spray Down Pump-Out Hose (Optional Equipment)		X		X
Bilge System				
Check Hull Drain Plug Tightness	X	X	X	X
Check Bilge Pump Operation	X	X	X	X
Check Automatic Float Operation	X	X	X	X
Check Bilge Blower Operation	X	X	X	X
Check Blower Hoses For Kinks	X	X	X	X
Check Auto Fire Ext. Operation (Optional Equipment)		X	X	X



SERVICE/MAINTENANCE LOG		
DATE	HOURS OF OPERATION	SERVICE/REPAIRS PERFORMED

Troubleshooting

DIAGNOSTIC CHARTS

The following diagnostic charts will assist you in identifying minor electrical, electronic, fuel, and mechanical problems. Some of the items listed require technical training and tools. Additional assistance is available in the engine manufacturer's manual. Also, you can contact your closest Regal dealer or marine professional for more information. Many times the root cause of a problem can be found by a step by step process of elimination.

	CAUTION
AVOID BODILY INJURY AND PROPERTY DAMAGE! SOME EQUIPMENT CONTAINS HIGH VOLTAGE. USE CAUTION WHEN TROUBLESHOOTING ELECTRICAL COMPONENTS.	

	CAUTION
AVOID BODILY INJURY AND PROPERTY DAMAGE! USE ONLY APPROVED MARINE REPLACEMENT PARTS.	

	WARNING
AVOID BODILY INJURY AND DEATH! BEFORE PERFORMING ANY MAINTENANCE WORK TURN OFF THE BATTERY SWITCH AND REMOVE THE KEYS FROM THE IGNITION SWITCH.	



REMOTE CONTROL DIAGNOSTIC CHART

PROBLEM	POSSIBLE CAUSE	POSSIBLE FIX
Remote control stiff/inoperative	Corroded cable	Clean/lubricate cable
	Kinked cable	Replace cable
	Broken cable	Replace cable
	Remote control box jammed	Repair/Replace box
Throttle only control inoperative (neutral)	Worn throttle cable	Replace cable
	Binding cable	Follow cable routing; look for pinched cable
	Broken cable	Replace cable
	Control box worn or in need of lubrication	Refer to information supplied by control mfg.

NOTE: THE ABOVE INFORMATION DOES NOT APPLY TO JOYSTICK EQUIPPED ENGINES.

Troubleshooting

INSTRUMENT DIAGNOSTIC CHART		
PROBLEM	POSSIBLE CAUSE	POSSIBLE FIX
No reading on gauge or gauge reads wrong	Faulty gauge Wiring to gauge faulty Faulty sender	Replace gauge Inspect/repair wiring Replace sender
Gauge reads erratic	Loose ground or hot wire	Repair or replace wire and or connection



FUEL SYSTEM DIAGNOSTIC CHART

PROBLEM	POSSIBLE CAUSE	POSSIBLE FIX
Engine won't start or not running right	Fuel tank vent obstructed	Clean vent hose or and fitting. Check for kinks.
	Fuel line blocked	Check for kinked hose
	Lack of fuel	Clean filter. Check for clogged anti-siphon valve (Call dealer)
	Water in fuel	Eliminate water
	Clogged engine water separator filter	Replace filter element
No fuel reaching engine	Check fuel pump output. Clean filters. Check fuel tank gauge level.	

Troubleshooting

PERFORMANCE DIAGNOSTIC CHART		
PROBLEM	POSSIBLE CAUSE	POSSIBLE FIX
Excessive vibration	Material obstructing propeller	Remove material by reversing engine
	Bent propeller shaft	Call Regal dealer
	Bent propeller blade	Repair/replace propeller
	Bent rudder or strut	Call Regal dealer
	Loose motor mount	Call Regal dealer
Poor performance	Hull bottom has buildup	Clean bottom
	Uneven load distribution	Adjust boat load Adjust ballast tanks
	Engine problem	Call Regal dealer



DC ELECTRICAL DIAGNOSTIC CHART

PROBLEM	POSSIBLE CAUSE	POSSIBLE FIX
No 12 volt power	Battery switch in "off" position	Turn selector switch to "on" position
	Weak or dead battery	Charge or replace battery
Battery not charging; (Engine running)	Loose belt	Tighten belt
	Faulty alternator	Repair/Replace alternator
Battery will not hold charge	Faulty volt meter	Replace volt meter
	Faulty/Old battery	Replace battery
12 volt equipment not working	Equipment switch "off"	Switch to "on" position
	Circuit breaker blown	Push reset on circuit breaker
	Weak or dead battery	Replace battery
	Corroded connection	Eliminate corrosion
	Loose wire	Tighten connection
Internal equipment short	Replace equipment	

Troubleshooting

AC ELECTRICAL DIAGNOSTIC CHART		
PROBLEM	POSSIBLE CAUSE	POSSIBLE FIX
No AC power	<p>Main shore power inlet breakers tripped or off</p> <p>Power at dock off</p> <p>Shore power cord not connected</p> <p>Faulty connection</p>	<p>Energize shore power inlet breakers</p> <p>Activate dock box power</p> <p>Plug in shore power: twist to lock</p> <p>Repair as needed</p>
No power to AC outlets & equipment	<p>Main breakers at AC control panel tripped or off</p> <p>Shore power not connected</p> <p>GFIC tripped</p>	<p>Activate main breakers or reset</p> <p>Plug in cord</p> <p>Reset GFIC</p>
Main breaker continues to trip	Faulty main breaker	Contact dealer
Inadequate AC power with genset running	Electrical demand greater than electrical output	Turn off equipment as needed



FRESH WATER SYSTEM DIAGNOSTIC CHART

PROBLEM	POSSIBLE CAUSE	POSSIBLE FIX
Air In System	Water Tank Empty	Fill Tank. With Pump Energized Bleed Air From Lines Until Water Flows Out.
Fresh Water Pump Cycles On And Off	Leak In Water System	Locate Water Leak And Repair.
No Water At Shower Or Sinks With Faucets On	Fresh Water Pump Breaker Off Water tank empty Blocked/Pinched Lines Loose Or Disconnected Wire	Switch Breaker To On Fill Water Tank Clear Obstruction Or Straighten Line. Check Connections: Tighten As Needed. Contact Your Dealer.
Low Water Pressure At All Sinks And Shower	Defective Pump	Contact Your Dealer.
Low Water Pressure At One Sink No water at ship's pressure water pump using dockside water	Pinched Or Plugged Water Line Dock silcock not activated One-way valve in cold water side faulty Obstruction in hose	Straighten Or Blow Out Line Turn on dockside silcock (faucet) Replace one-way valve Clear obstruction in dockside hose

TOILET SYSTEM DIAGNOSTIC CHART

Troubleshooting Guide

<i>PROBLEM</i>	<i>CAUSE</i>	<i>ACTION/SOLUTION</i>
Toilet does not flush or flush performance is poor	Waste tank is full (tank indicator light on wall switch is RED)	Empty waste tank before continuing to use toilet. Override full tank lock-out. WARNING: THIS MAY CAUSE WASTE TANK TO OVERFLOW.
	Clog at pump inlet	Clear clog. DO NOT flush foreign objects.
	Solid object in macerator	Do not attempt to remove object from pump body. Contact Thetford/Tecma Service (1-800-521-3032). DO NOT flush foreign objects.
	Low voltage	Check that toilet supply voltage is 12V+/-2V (24V+/-2V) AND that there is no more than a 10% decrease in voltage when macerator is running. If voltage decreases more than this, there may be a wiring problem in the boat.
Water does not enter bowl during flush or water add cycle	Water supply line kinked or not connected	Check that supply line is properly connected to fresh water supply. Check for kinks in the supply line.
	No power to water pump	Check that fuse/circuit breaker has not tripped. Ensure all electrical connectors to pump are fully mated.
	Water supply has been turned off	Open water supply valves or reconnect power to supply pump.
	Solenoid not plugged into controller (where applicable)	Ensure wiring harness to solenoid is fully mated at both ends.
	Electronics control problem	Contact Thetford/Tecma Service (1-800-521-3032).
Water level in bowl has changed after flush	Flush refill mode has been changed	See "Programming" section in Owner's Manual.
Water continues dripping briefly into bowl after flush cycle is complete	Toilet is installed below water line with vacuum breaker in water supply line	Normal operation – if only a small amount of water drips from nozzle.
Bowl drains dry after flush	Water is siphoning out of bowl	Discharge hose from macerator pump bent. Straighten hose.
Wall switch does not appear to light up or does not stay lit	No power to toilet	Check that fuse/circuit breaker has not tripped. Ensure all electrical connector are fully mated.
	Wall switch not properly connected to toilet.	Ensure wall switch electrical connector is fully mated at controller.
	Wall switch has entered Sleep Mode	Wall switch enters Sleep Mode after eight hours of continuous inactivity but remains functional. No action required.
	Wall switch electronics problem	Contact Thetford/Tecma Service (1-800-521-3032).
Toilet is inoperative and there is no lighting in the wall switch	No power to toilet	Check that fuse/circuit breaker has not tripped. Ensure all electrical connector are fully mated. Contact Thetford/Tecma Service (1-800-521-3032).

NOTE: This Troubleshooting Guide is intended to provide a basic service aid in the case of incorrect toilet operation. If the suggested actions above do not resolve the issue, it may be necessary to bring unit in for professional service. **Thetford Customer Service – 1-800-521-3032**



AIR CONDITIONER DIAGNOSTIC CHART

FAULT	POSSIBLE CAUSE	POSSIBLE FIX
A/C will not start	Circuit breaker off	Turn on at ship's main AC panel
	Shorepower voltage at dock too low	Check AC input voltage at ship's
No cooling or heating	Temperature set too low or too high	Raise or lower temperature as required
	Control program for heat or cool	Reprogram for heat, cool or automatic
	Obstructed sea water flow	Clean sea water strainer Check hose output flow
	Sea water pump has air lock	Remove hose from pump discharge to remove airlock
Fan is not running	Air flow blocked	Locate obstruction, clean return filter and grill
Coil is iced over	Thermostat set too low	Raise thermostat
	Improper air flow	Clean return air filter; remove obstructions, check for restricted ducting
HHH is displayed	High pressure switch open Not enough sea water flow	Check seacock, hoses, strainer, AC pump for restrictions
PPP is displayed	Low pressure switch is open	Restart AC unit
AC or heat runs continuously	Temperatures are set too low for cooling; too high for heating	Raise or lower set temperature
	Porthole, window, hatch or door open	Close all appendages

Troubleshooting

REFRIGERATOR DIAGNOSTIC CHART		
PROBLEM	POSSIBLE CAUSE	POSSIBLE FIX
Refrigerator not cold	Compressor will not start	Make sure the breaker is activated at the main AC panel
	Thermostat set too high or on-off switch is off	Reset thermostat or activate on-off switch
	Compressor starts but does not cool fridge	Contact repair center
	Door latch not closing or seal not seated	Adjust latch or replace seal
	Condensor dirty	Remove fridge and clean coils with duster or vacuum
Not running on DC	Check for defective thermostat or converter, low battery	Replace thermostat, converter or battery
Not running on AC	Inadequate input voltage	Make sure proper voltage exists on ship's main AC panel



DVD DIAGNOSTIC CHART

PROBLEM	POSSIBLE CAUSE	POSSIBLE FIX
No Sound	Poor connections at DVD player	Check to see DVD player is connected right
	TV not set up properly	Check TV settings
No picture	Poor connections at DVD player	Check to see DVD player is connected right
	AV 1 not selected on remote control	Select AV 1
Unit does not play	No disc in player	Insert disc in player
	Disc installed upside down	Reinstall disc correctly
	Dics scratched, broke or excessively dirty	Replace disc
	Moisture in player	Dry out player by letting it stand 1 hour
Remote control not functioning	Object inbetween player and remote	Obtain clear pathway for remote
	Batteries weak or dead	Replace batteries







Troubleshooting

TELEVISION DIAGNOSTIC CHART		
PROBLEM	POSSIBLE CAUSE	POSSIBLE FIX
Screen is black. Power indicator is off.	TV breaker not activated	Activate TV breaker on ship's main AC panel.
	TV and/or DVD not turned on	Activate TV or DVD player
TV signal weak	TV antenna breaker not activated or wrong antenna button in use	Activate TV antenna breaker. Check antenna switch for proper signal button
Image too light or dark	Brightness or contrast improperly adjusted	Readjust brightness or contrast to owner's manual specs
Horizontal bars appear to flicker, jitter or shimmer on the image	Fine function not adjusted properly	Adjust fine function to owner's manual specs
Vertical bars appear to flicker, jitter or shimmer on the image	Coarse function not adjusted properly	Adjust coarse function Then adjust fine function
Screen is blank and power indicator light is steady amber or blinks every 1/2 or 1 seconds	Power management system being used	See power saver in owner's manual
Image not centered on screen	Horizontal or vertical adjustments off	Readjust horizontal or vertical controls

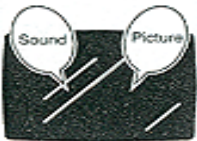

■ Before calling for repair services, make the following checks for possible remedies to the encountered symptoms.

TV set

Problem	Check item	Reference Pages
 <p>There is no picture or sound.</p>	<ul style="list-style-type: none"> • Make sure the AC adapter is properly inserted in the power outlet. • Reception other than those of broadcasting stations can be considered. • Make sure the input mode is set to TV. • Make sure the MAIN POWER switch of the main unit is on. 	<p>11</p> <p>–</p> <p>22</p> <p>21</p>
 <p>There is no picture. There is no picture from AV-IN1/2.</p>	<ul style="list-style-type: none"> • Make sure the BLACK LEVEL is properly adjusted. • Fluorescent lamp may have reached the end of service life. • Make sure the S-VIDEO terminal has nothing connected. • Make sure the AUDIO ONLY is not set to ON. 	<p>32, 33</p> <p>52</p> <p>48</p> <p>29</p>
 <p>There is no sound.</p>	<ul style="list-style-type: none"> • Make sure the volume is not set to minimum. • Make sure the sound is not set to mute. • Make sure that headphones are not connected. 	<p>23</p> <p>23</p> <p>23</p>
 <p>There is no picture or sound, just noise.</p>	<ul style="list-style-type: none"> • Make sure the antenna cable is properly connected. • Bad reception could be the problem. 	<p>10</p> <p>–</p>
 <p>Picture is not clear.</p>	<ul style="list-style-type: none"> • Make sure the antenna cable is properly connected. • Bad reception could be the problem. 	<p>10</p> <p>–</p>
 <p>Picture is light or improperly tinted.</p>	<ul style="list-style-type: none"> • Check color adjustment. • Check COLOR SYSTEM setting. 	<p>32, 33</p> <p>32, 33</p>
 <p>The picture is too dark.</p>	<ul style="list-style-type: none"> • Press the BRIGHT button or set the BRIGHTNESS settings. • Check PICTURE and BLACK LEVEL adjustment. • Fluorescent lamp may have reached the end of service life. 	<p>27</p> <p>32, 33</p> <p>52</p>
Remote control does not work.	<ul style="list-style-type: none"> • Check the batteries of the remote control. • Make sure the remote sensor window is not under strong lighting. 	<p>8</p> <p>8</p>
The clock (AUTO CLOCK) cannot be set.	<ul style="list-style-type: none"> • The broadcasted EDS signal may be weak. Check the antenna. • Carry out EZ SETUP, SETTING THE CLOCK again. • If EDS signal is not sent, set the clock using MANUAL CLOCK Setting. 	<p>–</p> <p>17–19, 35</p> <p>19</p>

Storage & Winterization

NOTICE

YOUR WARRANTY DOES NOT COVER DAMAGE TO YOUR BOAT IF IT IS NOT PROPERLY STORED AND WINTERIZED. CHECK WITH A REGAL DEALER OR MARINE PROFESSIONAL ABOUT WINTERIZATION PROCEDURES.

NOTICE

REMOVE ALL BATTERIES WHEN VESSEL IS STORED FOR EXTENDED PERIODS.



WARNING

EXPLOSION, FIRE AND POLLUTION HAZARD!
DO NOT FILL FUEL TANK TO RATED CAPACITY. LEAVE ROOM FOR EXPANSION.

INTRODUCTION

Storage procedures are outlined in this chapter. Remember, these are *general guidelines* used over the winter months in colder climates. Be sure to familiarize yourself with all relevant information in the owner's document pouch. Special winterization procedures are necessary for the boat equipment and systems. Use the enclosed checklists to assist you in identifying areas of concern and maintenance. These lists cover land stored boats either inside or outside. Contact your Regal dealer for additional information.

DECOMMISSIONING CHECKLIST

ENGINE

- Run engine. Pour a fuel stabilizer/conditioner in the fuel tank. Allow time for it to circulate through the fuel system.
- Change all engine fluids as referenced in the engine manufacturer's owners manual.
- Drain cooling and exhaust system or have a marine professional "pickle" the engine with antifreeze and rust preventative.
- Spray all exterior parts with a rust preventative.



Chapter 10

- Change engine and stern drive oil along with steering fluids.
- Remove drive. Perform maintenance as referenced in the manufacturer's owner manual including checking seals for vacuum and pressure at an authorized dealer.
- Check all belts for wear and tension.
- Remove propeller package. Refurbish as needed.
- Touch up paint on stern drive upper and lower gear housings as required.
- Apply rust inhibitor to driveshaft & universal joints. Grease universal joints if equipped with zerk fittings.
- Check exhaust, fuel, and cooling systems for leaks.
- Keep the unit trimmed down to assist in draining any water still in the exhaust system. Also, this position allows the universal to set without extra pressure on the bearings.

BOAT

- Check hull bottom for any fiberglass damage. Repair as needed.
- Apply marine wax to hull and deck surfaces.
- Pour a pint of 50/50 antifreeze into bilge pump.
- Remove batteries. Charge as needed.
- Remove all loose gear from boat such as life jackets, etc. Inspect and store in a cool, dry environment.
- Remove drain plug. Clean drain plug hole of debris as needed. Insert drain plug in plastic bag and tie to steering wheel.
- Drain the waste system per instructions in this chapter. Make sure bow is higher than stern to permit proper drainage.
- Clean all upholstery and store in a dry environment.
- Conduct a visual inspection to ensure boat is balanced properly on the trailer, cradle or blocks.
- Cover boat with tarp. Tie down for wind protection if outside. Prop tarp up as needed to provide additional ventilation. Be sure not to cover up the fuel vents.
- Drain the fresh water system per instructions in this chapter.
- Do not block up boat bottom as this may cause structural problems.** Store the vessel on a properly adjusted trailer or cradle.

Winterization

GENERAL NOTE ON ANTIFREEZE

Engine cooling fluids must be replaced with a marine antifreeze solution; mix antifreeze according to directions for the lowest expected temperature. The above method is much more reliable than just draining the engines and manifolds because sometimes pockets of water can form which can freeze in cold temperatures and cause engine damage. Draining the system fosters rust in engine parts. Remove the batteries and check the electrolyte level. Store in a cool, dry place. Monthly recharging or continuous trickle charging should be done to insure your batteries life during storage.

NOTICE

USE PROPYLENE GLYCOL
NON-TOXIC ANTIFREEZE
IN THE FRESH WATER & WASTE SYSTEM
AVAILABLE AT RV & MARINE DEALERS.
NEVER USE AUTOMOVIVE TYPE
ANTIFREEZE. IT CAN BE HIGHLY
POISONOUS & CORROSIVE.

FUEL SYSTEM:

Fill the fuel tank below the capacity to minimize condensation but do not overfill. Leave enough space for fuel to expand and add a gasoline/fuel stabilizer to fuel prior to storage following the manufacturer's recommended procedures.

BATTERIES:

Remove the batteries from the vessel and check the electrolyte level. Add distilled water to the cells as needed to the proper level.

Store in a cool, dry place on wood not concrete. Monthly recharging or continuous trickle charging should be done to insure battery life during storage.



FRESH WATER SYSTEM:

1. Turn on the fresh water pump switch.
2. Open all faucets including transom shower and allow tank to empty.
3. Drain the water heater; shut off water pump switch.
4. Mix nontoxic antifreeze with water in accordance with the manufacturer's recommendations.
5. Pour solution into the fresh water tank.
6. Turn on fresh water pump switch.
7. Open each cold water faucet one by one beginning with the one furthest away from the tank and purge the system until a steady stream flows from the faucet. Then close the faucet.
8. Repeat step 7 for hot water faucets.
9. Shut off water pump switch.
10. Pour a quart of nontoxic antifreeze into shower drain. Run the shower pump until a steady stream flows from the discharge fitting.
11. Leave at least 2 gallons of antifreeze solution in the holding tank during storage.

ELECTRIC TOILET

1. Operate the toilet in the dry bowl mode to evacuate as much water as possible. Drain the remaining water from the base by removing the base plug or sponge from bottom of bowl.
2. When filling the holding tank by pumping it through the toilet, use only ethylene glycol based antifreeze not petroleum based anti-freeze.

WASTE/VACUFLUSH TOILET SYSTEM:

1. Pump out waste holding tank, flush the tank with fresh water and pump out again.
2. With nontoxic propylene glycol type antifreeze in the fresh water tank, operate head until antifreeze flows into bowl of head.
3. Operate macerator until antifreeze has a steady flow coming from the discharge fitting. Pour nontoxic antifreeze solution in head and flush head as needed to winterize macerator pump.
4. Leave at least 2 gallons of antifreeze solution in the holding tank during storage.
5. For further information see the toilet owner's manual in the document pouch

AIR CONDITIONING:

There are several methods of winterization that can be used with your AC unit. Use only 50/50 non-polluting biodegradable antifreeze/water solution. See your AC manual in your owner's pouch for more information or call your Regal dealer.

1. Open seacock and allow water to drain if boat is out of the water. Clean out the seacock and close it.
2. Open top of strainer and fill with antifreeze solution.
3. Operate air conditioning pump refilling sea strainer with antifreeze as the level goes down.
4. Continue to operate pump until antifreeze flows out of thru-hull fitting.
5. Shut off air conditioning pump and install the seawater strainer top.

Glossary

Below is a brief list of nautical terms useful in everyday boating communications. For more detailed glossaries and nautical terminology, we recommend you check your local library.

GLOSSARY

Abeam: at right angles to the fore and aft line and off the boat

Aboard: on or in the boat

Above: the part of the boat on a bavin vessel which is above the interior of the boat

Aft, After: aft is the boat section toward the stern or back of the boat

Admidships: toward the center of the boat from either side to side or rear to front

Beam: the width of a boat at its widest part

Bilge: the lower interior of the hull of the boat

Bitter end: the end of a line also the end of an anchor line

Bow: the front, or forward part of the boat

Bulkhead: the vertical partition or wall of a boat

Cast off: to let go or release

Chine: the line fore and aft formed by the intersection of the side and bottom of the boat

Chock: deck fitting used to secure or guide anchor or tie lines

Cleat: deck fitting with protruding arms around which lines are secured

Cockpit: the seating space used to accomodate passengers

Cuddy: a small cabin in the fore part of the boat

Deck: the open flooring surface on which crew and passengers walk



Chapter 11

Draft: the depth from the waterline of the boat to the lowest part of the boat, which indicates how much water is required to float the boat

Fathom: a measurement of depth; one fathom equals six feet

Fender: a cushion hung from the side of a boat to prevent it from rubbing against a dock or against other boats

Fend off: to push off to avoid sharp contact with dock or other vessel

Fore: the part of the boat toward the bow or front

Freeboard: the height of the top side from the waterline to the deck at its shortest point. (The distance from the sheer or gunwale to the water)

Galley: cooking area

Gunwale: rail or upper edge of the side of the boat

Hatch: an opening in the deck to provide access below

Head: toilet

Hull: the part of the hull from the deck down

Keel: the lowest point of a boat; the backbone of the vessel

Knots: a measurement of speed indicating nautical miles per hour

Lee: the side opposite that from which the wind is blowing; the side sheltered from the wind

Leeward: the direction toward which the wind is blowing

PFD: personal floatation device; required for each person aboard

Port: the left side of the boat when facing forward (an easy way to remember the difference between “port” and “starboard” is that both “port” and “left” have four letters)

Shank: the main body of an anchor

Sheer: the curve of the boat’s deck from fore to aft when seen from the side

Starboard: the right side of the boat when facing forward

Stern: the aft end of the boat

Stern drive: an inboard/outboard (IO) unit

Stringer: strengthening integral unit fastened from fore to aft inside the hull and fiberglass encapsulated for added strength; much like the skeleton system of our body

Top off: to fill up a tank

Transom: the vertical part of the stern.

Trim: the boat’s balance when properly loaded

Wake: the path of a boat left astern in the water

Glossary & Index

A

AC Current	5-14
Accidents	2-17
Accident Reporting	2-18
Air Conditioner	7-2
Alcohol Myths & Facts	2-17
Anchoring	6-11
Audible Alarms	4-2

B

Battery	5-2
	8-21
Battery Charger	5-3
Battery Management Center	5-4
Bilge Pump	5-5
	8-23
Blower	5-4
	8-23
Breakers	5-9
	5-11
	5-17
Breast Lines	6-6
Bridge Clearance	3-8

C

Cabin Door	7-41
Canvas	7-43
	8-4
Carbon Monoxide	2-14
Carbon Monoxide Detector	7-12
	8-10
Cardiopulmonary Resuscitation	6-16
Carpet	8-1
Center Windshield	7-37
Cockpit Aft Seating	7-40
Compass	7-37
Corian	8-2
Cosmetic Care	8-1
Controls	4-3

D

Dealer Responsibilities	1-10
Decommissioning	10-1
Depth Sounder	4-4
	7-51
Diagnostic Charts (Troubleshooting)	9-1
Dinette	7-34
Direct Current (DC)	5-1
Distress Signals	2-7
Diver's Flag	2-19
Docking	6-8
Dock Lines	6-6
Dockside Water Inlet	7-19
Drain Plug	6-2

E

Electrical	5-1
	Technical
Electrolysis	8-27
Engine Alignment	4-1
Engine	8-25
	9-1 to 9-6
	10-1
Environmental Awareness	6-15
Equipment Operation	7-1
Exhaust	2-14

F

Fenders	6-5
Fiberglass & Gelcoat Maintenance	8-2
Fire Extinguishers	2-6
Fire Extinguishing System	7-48
Fires	6-14
First Aid	6-14
Float Plan	1-7
Fresh Water System	5-28
	10-4
Fresh Water Plumbing	8-13
Fresh Water Pressure Pump	7-19
Fresh Water Tank	8-24
Fuel System	5-22
	6-3
	8-23
	10-3



Chapter 11

G		M	
Galvanic Isolator	5-16	Maneuvering	6-9
	7-21	Maintenance Log	8-32
Gas Vapor Detector	5-10	Maintenance Schedule	8-29
Gathering Headway	6-9	Maintaining PFD'S	2-6
Gelcoat Maintenance	8-2	Mayday	2-10
General Boating Safety	2-2	Metal (Cleaning)	8-5
Getting Underway	6-1	Mid Berth To Sleeper Conversion	7-40
Glossary	11-1	Minimum Required Equipment	2-13
GFCI	5-20	Monitor System	7-29
		Mooring	6-6
H		N	
Hatch	7-30	Navigation Aids	3-5
Helm Seat	7-39	Navigation Lights	2-10
HIN	1-3	Navigation Rules	3-1
Horn	2-10	Neutral Safety Switch	4-9
	5-5		
	3-2		
	8-19		
Hot Water Heater	7-20		
	8-12		
Hull Bottom	8-5		
Hypothermia	6-15		
I		O	
Ignition Switch	5-7	Oil Spills	2-10
Index	11-3	Overboard Discharge Pump	7-13
Instruments (Gauges)	4-4		8-24
International Distress Signals	4-4	Overloading	2-3
		Owner's Pouch/Document Box	1-4
		Owner Responsibilities	1-11
K		P	
Knots	6-13	Personal Flotation Devices	2-4
		Plastics	8-1
		Playing a DVD Disc	7-29
		Pollution Regulations	2-10
		Porpoising	5-21
		Pre-departure questionnaire	6-1
		Propellers	4-3
			8-25
L			
Lights	2-10		
Ladder (Swim)	7-50		

Glossary & Index

R

Refrigerator	7-36
	8-17
Registration Information	1-10
Remote Control	4-8
	5-6
	8-20
Right-Of-Way	3-1
Rules Of The Road	3-1

S

Safety Labels	2-1
Seawater Strainer	8-29
Seacocks	7-1
	8-29
Seating	7-48
Shorepower	5-13
Shower Sump Pump	8-10
Sirius Satellite Radio	7-60
Sound Producing Devices	2-10
Specifications	Technical
Speedometer	4-4
Spotlight	7-46
	8-19
Spring Line	5-11
Strainer	8-29
Stern Line	6-6
Steering	5-19
	8-27
Stereo	7-14
Stereo Remote	5-5
Stove	7-37
Sunbrella Canvas Cleaning	8-4
Sump (Bilge)	7-54
Swim Platform	2-19
	7-57
	8-20
Switches (DC)	5-6
	5-8
Switches (AC)	5-14

T

Tachometer	4-4
Table-V Berth	7-40
Technical Drawings	12-3
Television	7-20
Temperature Gauge	4-4
Towing	6-12
Trailerling	7-61
Transom Shower	7-10
Transom Switch Panel	7-17
Trim	5-20
Trim Tabs	5-21
Troubleshooting	9-1

U

Upholstery	8-1
------------	-----

V

VHF	2-10
VacuFlush Head	8-12
Ventilation	4-2
Vessel Information Sheet	1-6
Visual Distress Signals	2-7
Volt Gauge	4-5

W

Warranty	1-12
Water/Waste System	7-4
Water Sports	2-19
Weather	2-20
Windlass	7-41
	8-19
Windows	7-49
Windshield Wiper/Latch	7-29
	8-18
Winterizing	10-1



Notes

Technical



TECHNICAL INFORMATION

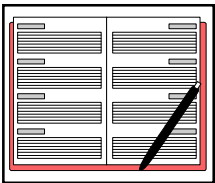

The following technical information is accurate up to the date of printing listed at the beginning of this manual. Note that all product specifications, models, standard and optional equipment, systems, along with the technical information is subject to change without notice. For more information contact your nearest authorized Regal dealer. For the location of your nearest authorized dealer call 407-851-4360 or you can contact Regal through the internet at : (www.regalboats.com). Your Regal dealer has received special factory training on the entire product line and his services should be employed to solve more technical problems.

Many of the technical drawings found in this chapter are actual product drawings from the Regal factory. These drawings should be of special interest in mechanical and electrical troubleshooting. The equipment in the drawings is discussed in various sections of this manual. Please read and understand the system and related drawings to help you solve a problem on your vessel. When all else fails contact your closest Regal dealer for assistance.

28 EXPRESS TYPICAL SPECIFICATIONS

LENGTH OVERALL	28' 10"	8.78 M
BEAM	8' 6"	2.6 M
DEADRISE AT TRANSOM	18 DEGREES	18 DEGREES
EST. DRY WEIGHT	7585 LBS	3440 KG
EST. BRIDGE CLEARANCE	9' 9"	2.9 M
EST. COCKPIT DEPTH	29"	0.7 M
EST. CABIN STORAGE	36 CU. FT.	1.01 CU. M
EST. COCKPIT STORAGE	34 CU. FT	.96 CU. M
EST. DRAFT-DRIVE UP	34"	0.86 M
EST. FUEL CAPACITY	72 GALS	272 L
EST. FRESH WATER CAPACITY	20 GALS	75 L
EST. WASTE TANK CAPACITY	18 GALS	105 L
EST. MAX. CABIN HEADROOM	5' 11 1/2"	1.81 M
SLEEPING CAPACITY	4	4
MAX. PERSONS CAP	YACHT CERTIFIED	CE 8

Technical Information

28 EXPRESS TYPICAL LABEL LOCATIONS

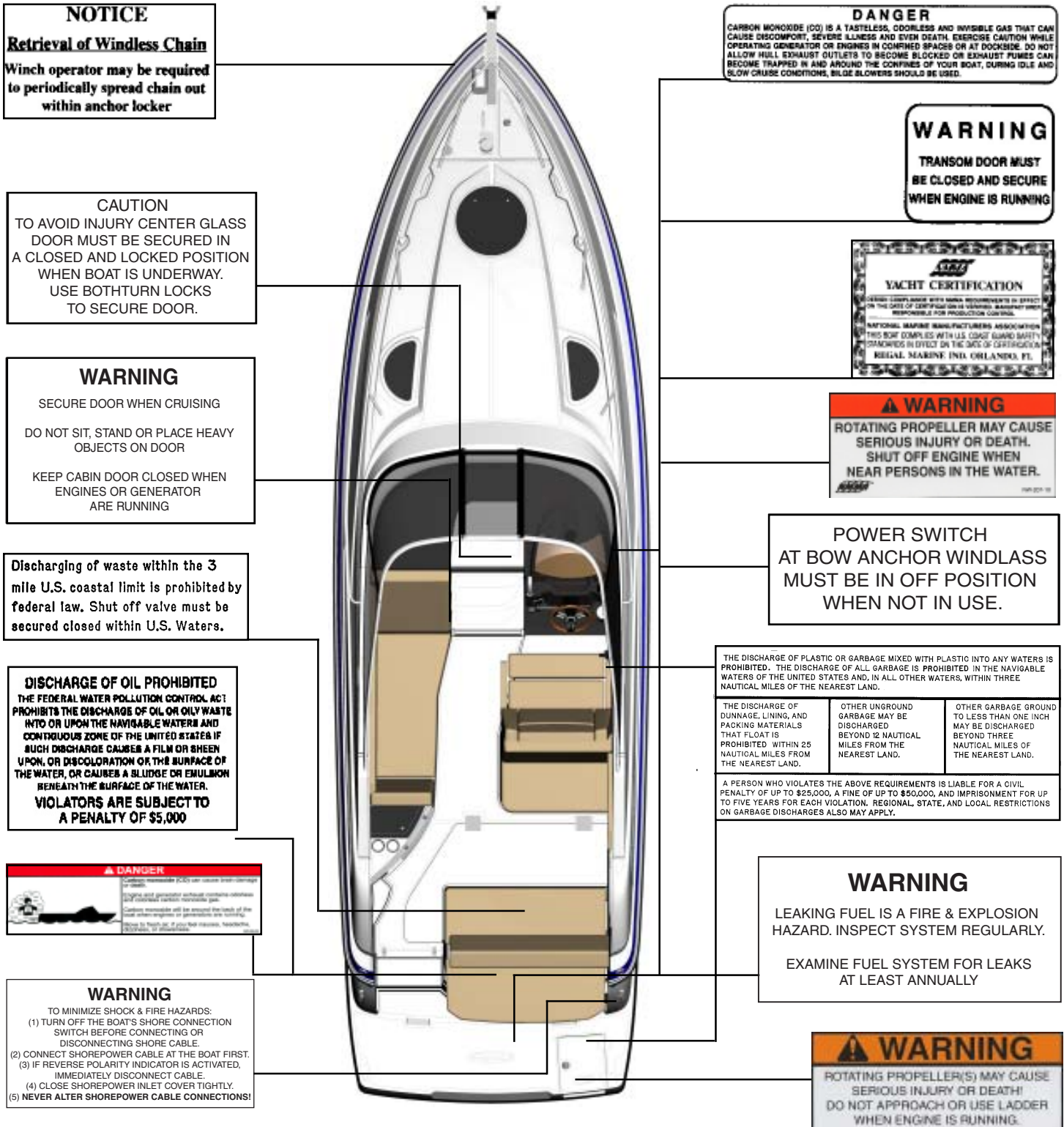



TYPICAL FUEL SYSTEM

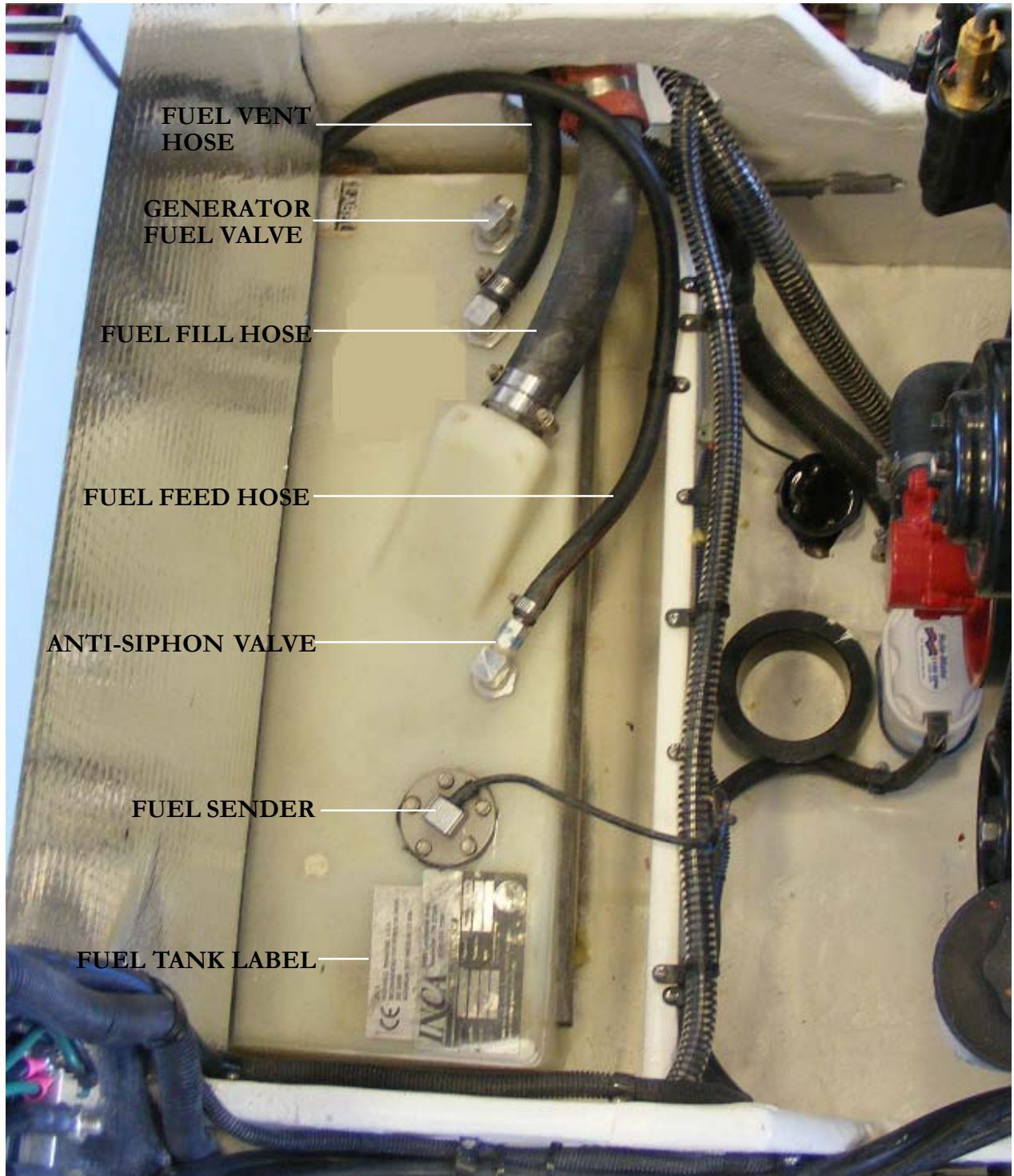

Technical Information



28 Express Deck Overview



28 Express Cabin Overview

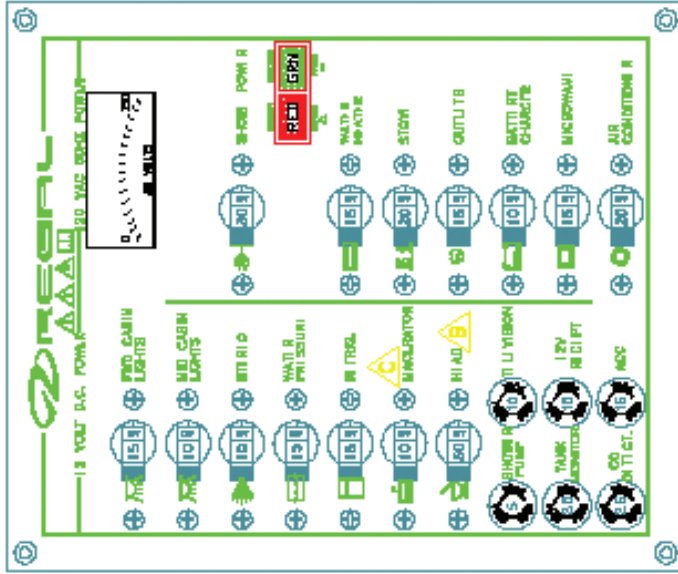

SHROUD:
N/A

RIPS: .125 5052 H32 ALUMINUM (51-2525-001)
PAINTED POLYME T BLACK W/ WHIT TEXT
P/N QTY. REV. DESCRIPTION
8805245 1 Δ B BIP 23-0108-542

ORDERING INFORMATION:

WT # N/A
MFG P/N DESCRIPTION CUST P/N
8517756 MDP 857989

ORDERED SEPARATELY

MFG P/N DESCRIPTION CUST P/N
N/A

GENERAL INFORMATION:

GAUGES:

P/N QTY. DESCRIPTION
022306001 1 0-150 VAC ANALOG VOLT METER

CIRCUIT PROTECTION:

- Δ 040808010 5 10A CB 1P WHT TOGGLE A-SER
- 040808015 8 15A CB 1P WHT TOGGLE A-SER
- 040808020 2 20A CB 1P WHT TOGGLE A-SER
- 040808030 1 30A CB 2P WHT TOGGLE A-SER
- 030401001 6 3AG GLASS FUSE HOLDER/CAP
- 030101003 2 2.5A 3AG GLASS FUSE (TK MON/CD)
- Δ 030103001 1 5A 3AG GLASS FUSE (SHOWER SUMP)
- 030107001 1 10A 3AG GLASS FUSE (TV)
- 030109001 2 1.5A 3AG GLASS FUSE (12V/ACC)

ACCESSORY ITEMS:

- P/N QTY. DESCRIPTION
- 100109001 1 DUAL RECT IND LT 125V RED/GRN
- 070303001 2 5 POS CND BUSS (BLUE SEA)
- 080401007 4 #6 FLAT WASHER 55 (METER/GNDG)
- 081201002 4 #6-32 X 1/4 STANDOFF 55
- 080804003 3 #6-32 NUTLOCK NUT (METER/GNDG)
- 081201007 2 #6-32 X 1/2 NYLON STANDOFF
- 030301008 2 FUSEBOARD 250 BRASS DN TABS
- 750750006 1 8 POS BUSS BAR (BRKR) (METER)
- 750750007 1 7 POS BUSS BAR
- 080602043 26 #6 X 3/8 BINDING SCREW
- 080402010 26 BRASS ET LOCK WASHER (BRKR)
- 080802040 28 #8-32 X 5/16 PH FL CS BUSH (BRKR)

HARNESSES:

P/N QTY. REV. DESCRIPTION
Δ 900002677 1 B PANEL WIRING

REGAL MARINE
28 EXPRESS MAIN PANEL

NOTES:

REV	DESCRIPTION	DATE	BY
4	121761 CHG MAGNETOR TO 10A	11-13-07	NEW
D	121729 DELIC SEAWATER PUMP JUMPER	8-18-07	NEW
E	121877 CHD FEM ELEM LOCATIONS	8-14-07	NEW
F	12203000 6A FUSE TO BON	8-13-07	NEW

8517756
B-1-00 MIS
SHEET 1 OF 1



28 EXPRESS HK
ANALOG/EVC IGNITION PANEL

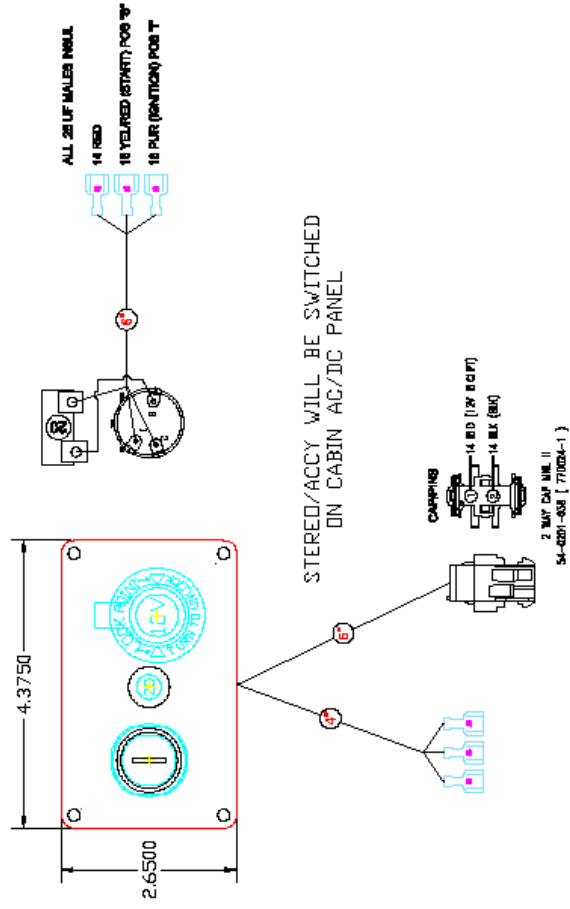

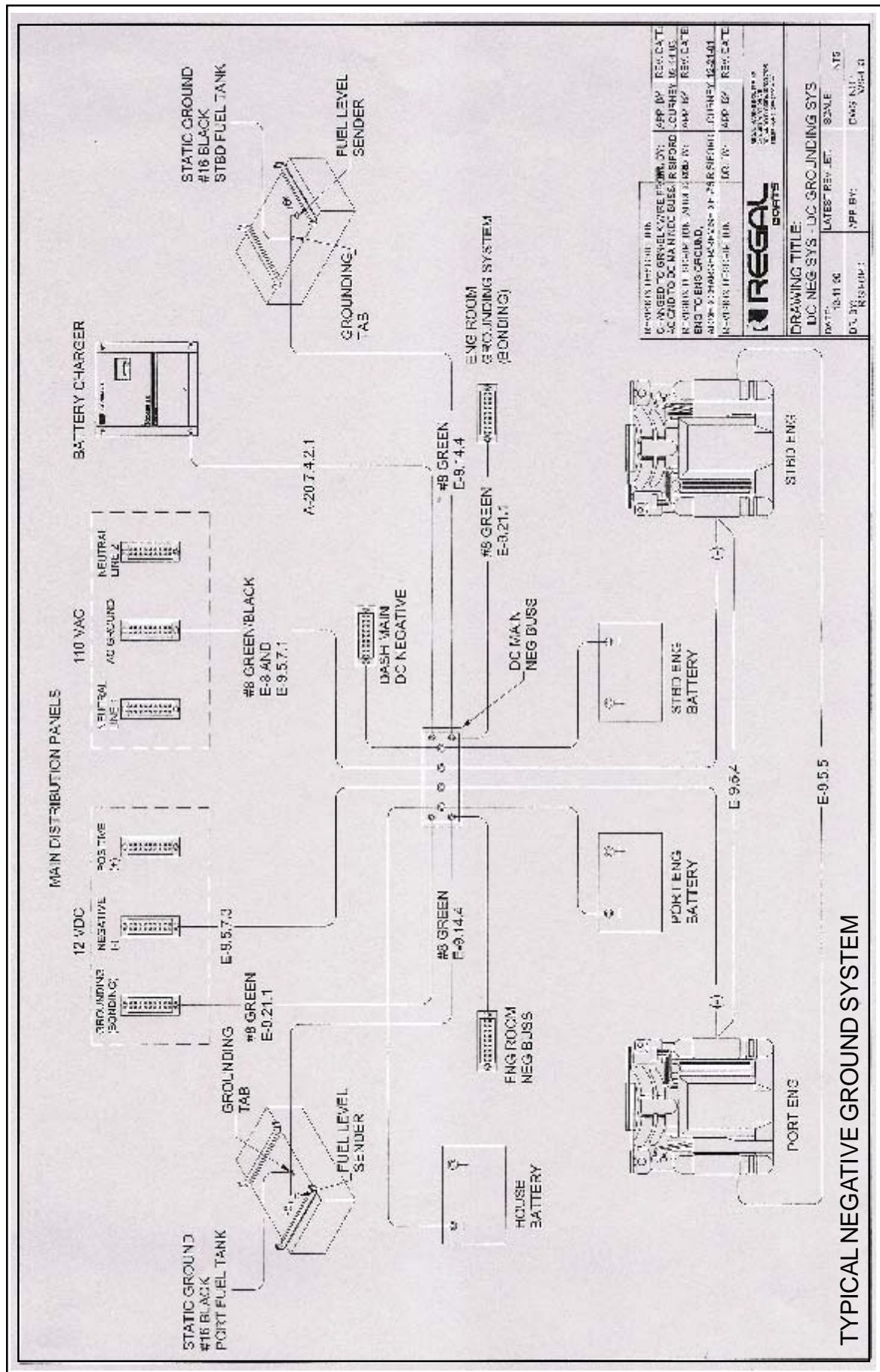

REVISIONS	DATE	BY	APP BY	REV. DATE
1	01/11/11	W. J. BROWN	W. J. BROWN	01/11/11
2	02/11/11	W. J. BROWN	W. J. BROWN	02/11/11
3	03/11/11	W. J. BROWN	W. J. BROWN	03/11/11
4	04/11/11	W. J. BROWN	W. J. BROWN	04/11/11
5	05/11/11	W. J. BROWN	W. J. BROWN	05/11/11
6	06/11/11	W. J. BROWN	W. J. BROWN	06/11/11
7	07/11/11	W. J. BROWN	W. J. BROWN	07/11/11
8	08/11/11	W. J. BROWN	W. J. BROWN	08/11/11
9	09/11/11	W. J. BROWN	W. J. BROWN	09/11/11
10	10/11/11	W. J. BROWN	W. J. BROWN	10/11/11
11	11/11/11	W. J. BROWN	W. J. BROWN	11/11/11
12	12/11/11	W. J. BROWN	W. J. BROWN	12/11/11

TYPICAL NEGATIVE GROUND SYSTEM

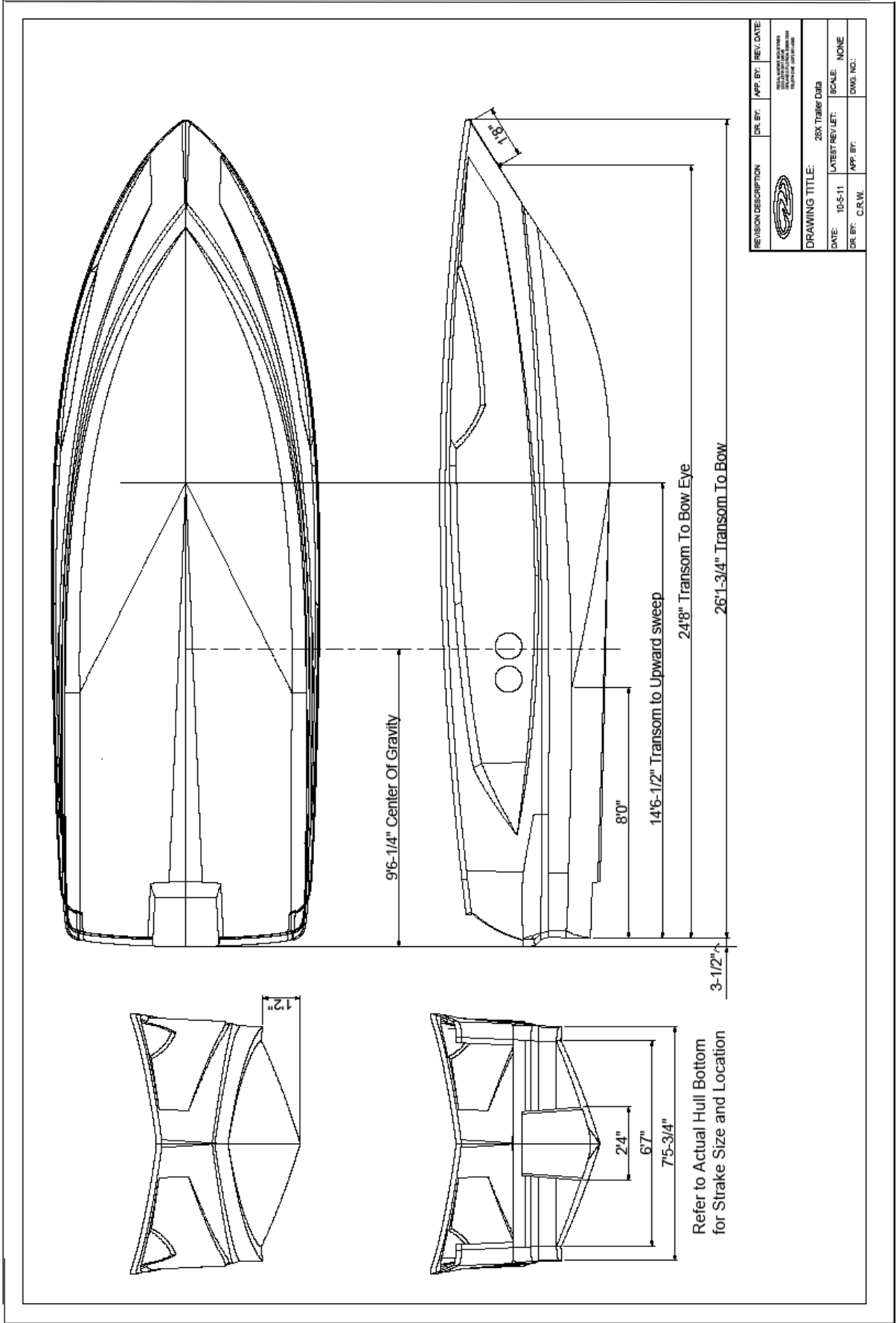

REVISION DESCRIPTION	DR. BY:	APP. BY:	REV. DATE
DRAWING TITLE: 25X Trailer Crib			
DATE: 10-5-11	LATEST REV. BY:	SCALE: NONE	DWG. NO.:
DR. BY: C.R.W.	APP. BY:		

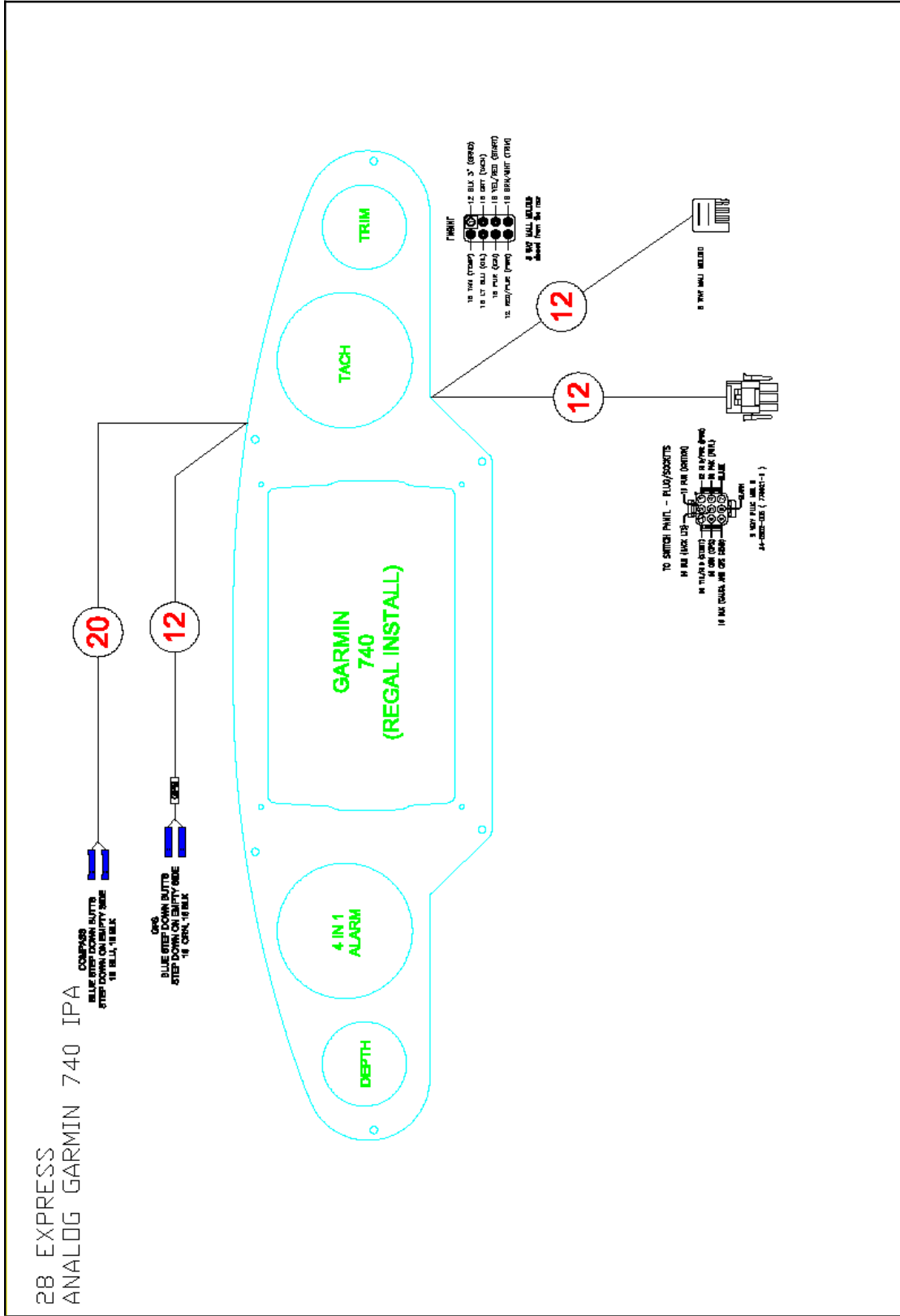

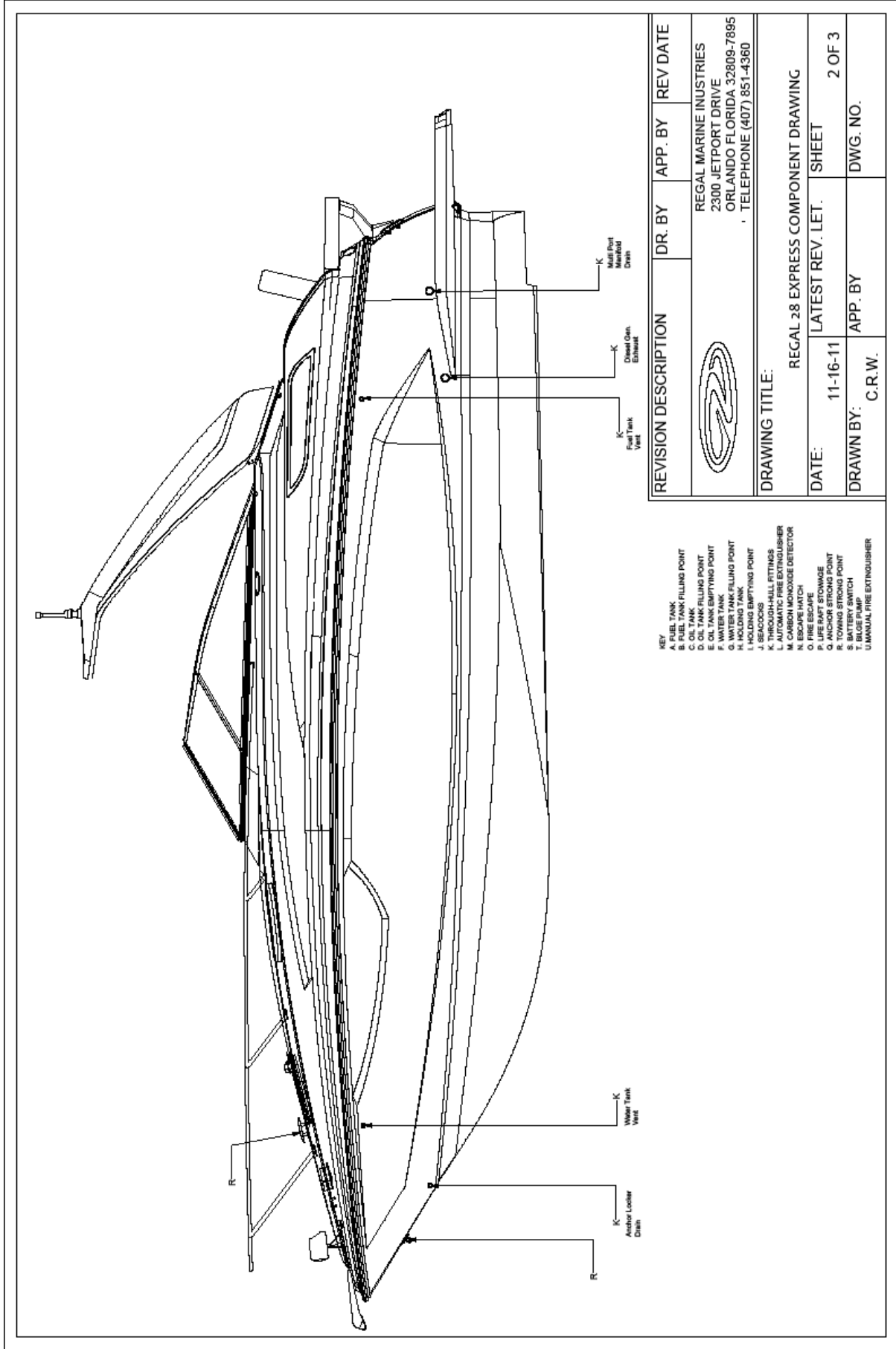

- KEY
- A. FUEL TANK
 - B. FUEL TANK FILLING POINT
 - C. OIL TANK FILLING POINT
 - D. OIL TANK EMPTYING POINT
 - E. WATER TANK
 - F. WATER TANK FILLING POINT
 - G. HOLDING TANK
 - H. HOLDING EMPTYING POINT
 - I. THROUGH-HULL FITTINGS
 - J. THROUGH-HULL FITTINGS
 - K. THROUGH-HULL FITTINGS
 - L. AUTOMATIC FIRE EXTINGUISHER
 - M. CARBON MONOXIDE DETECTOR
 - N. ESCAPE HATCH
 - O. FIRE ESCAPE
 - P. FIRE ESCAPE
 - Q. ANCHOR STRONG POINT
 - R. TOWING STRONG POINT
 - S. BATTERY SWITCH
 - T. BILGE PUMP
 - U. MANUAL FIRE EXTINGUISHER

REVISION DESCRIPTION	DR. BY	APP. BY	REV DATE
REGAL MARINE INDUSTRIES 2300 JETPORT DRIVE ORLANDO FLORIDA 32809-7895 TELEPHONE (407) 851-4360			
DRAWING TITLE:			
REGAL 28 EXPRESS COMPONENT DRAWING			
DATE:	11-16-11	LATEST REV. LET.	SHEET 2 OF 3
DRAWN BY:	C.R.W.	APP. BY	DWG. NO.

Technical Information

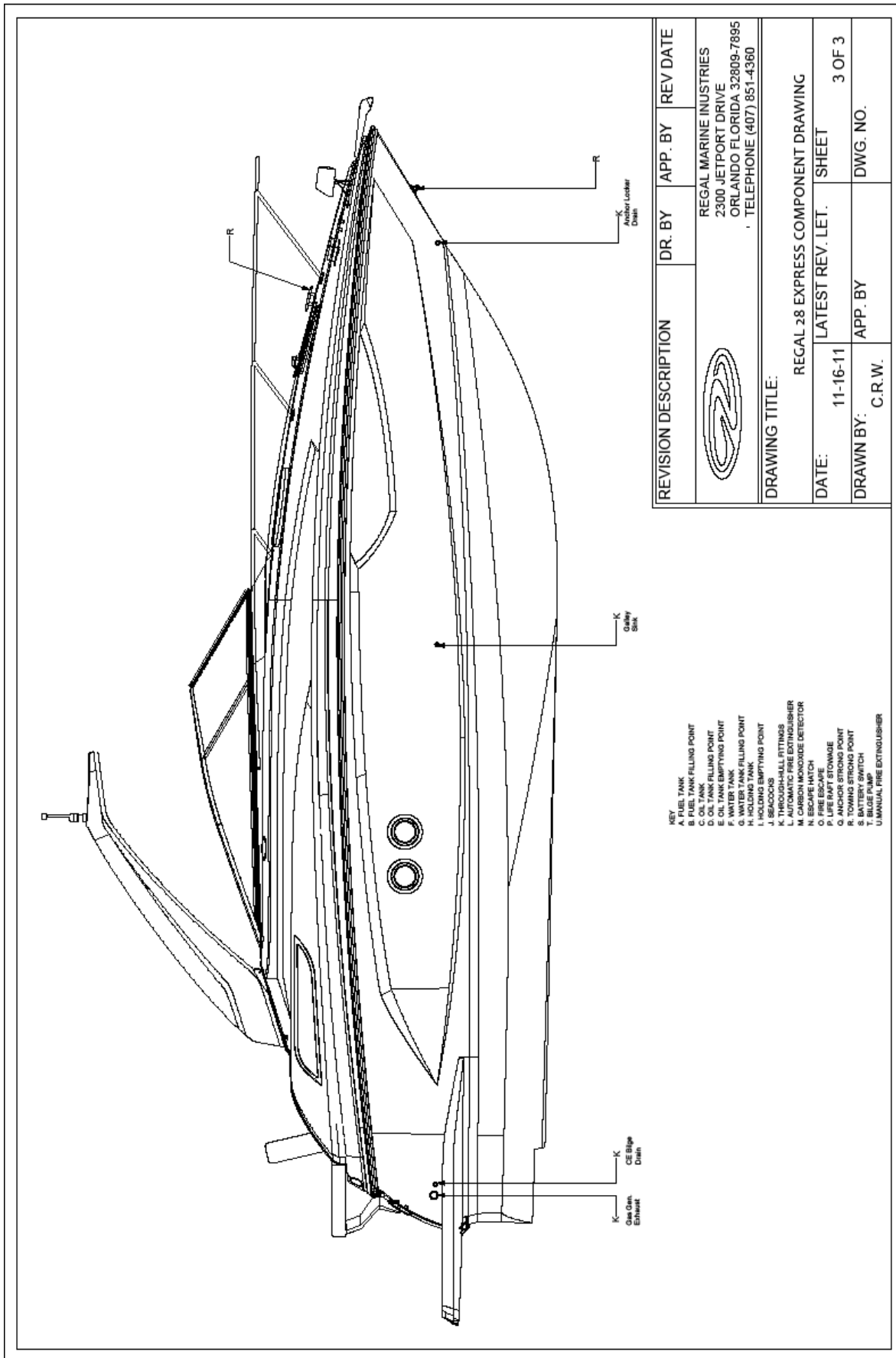

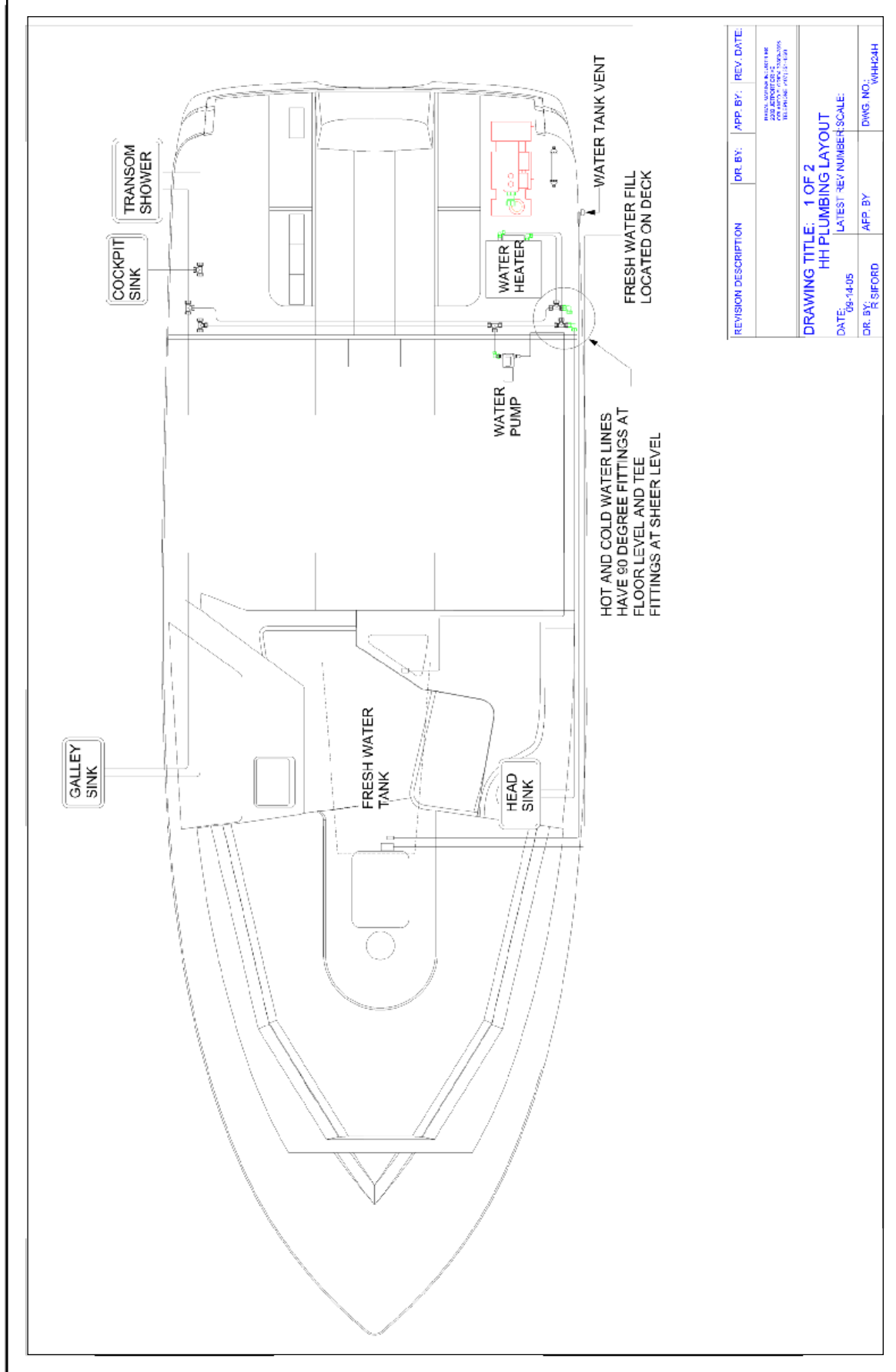

Technical Information

