

YACHT

SANLORENZO

SL
102/

SL 102/



01. Sophisticated and modern the new SL102 is a Sanlorenzo with peerless characteristics from a unique lineage.

SL
102/



SL
102/





04. Salon option A



05. Salon option A



06. Salon option B



07. Salon option B



08. Salon option C



09. Salon option C



10. Salon option C



II. Owner's cabin option A







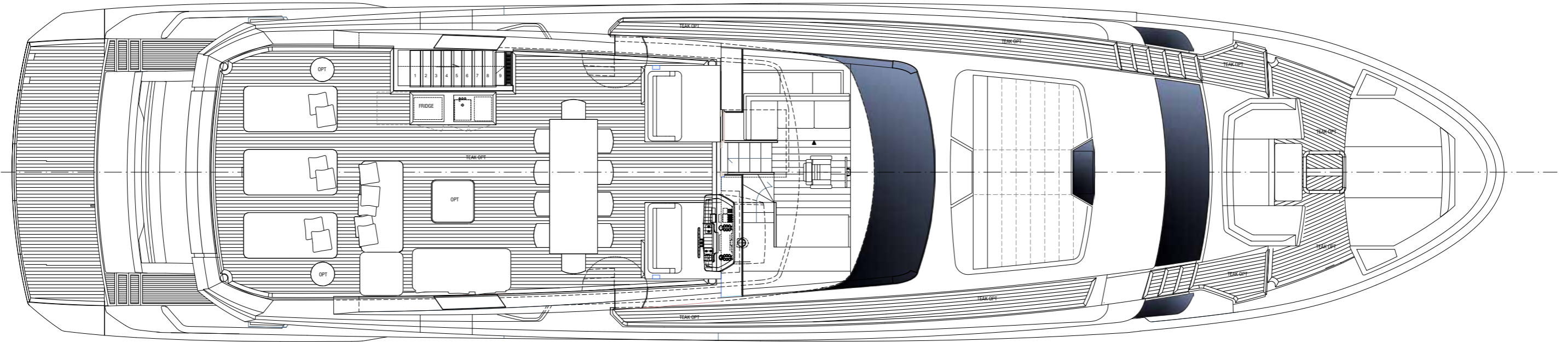

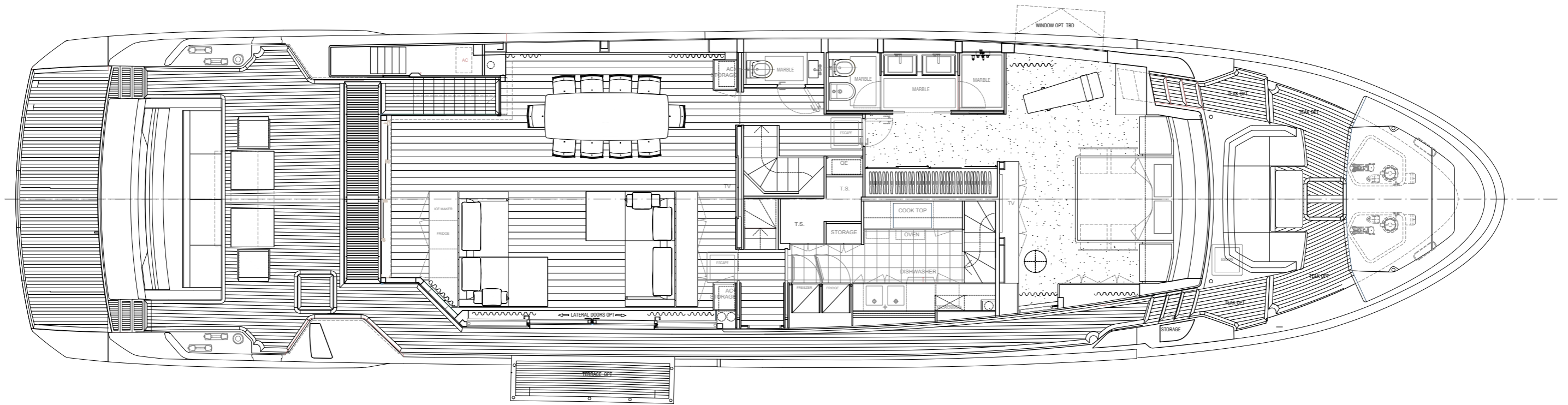

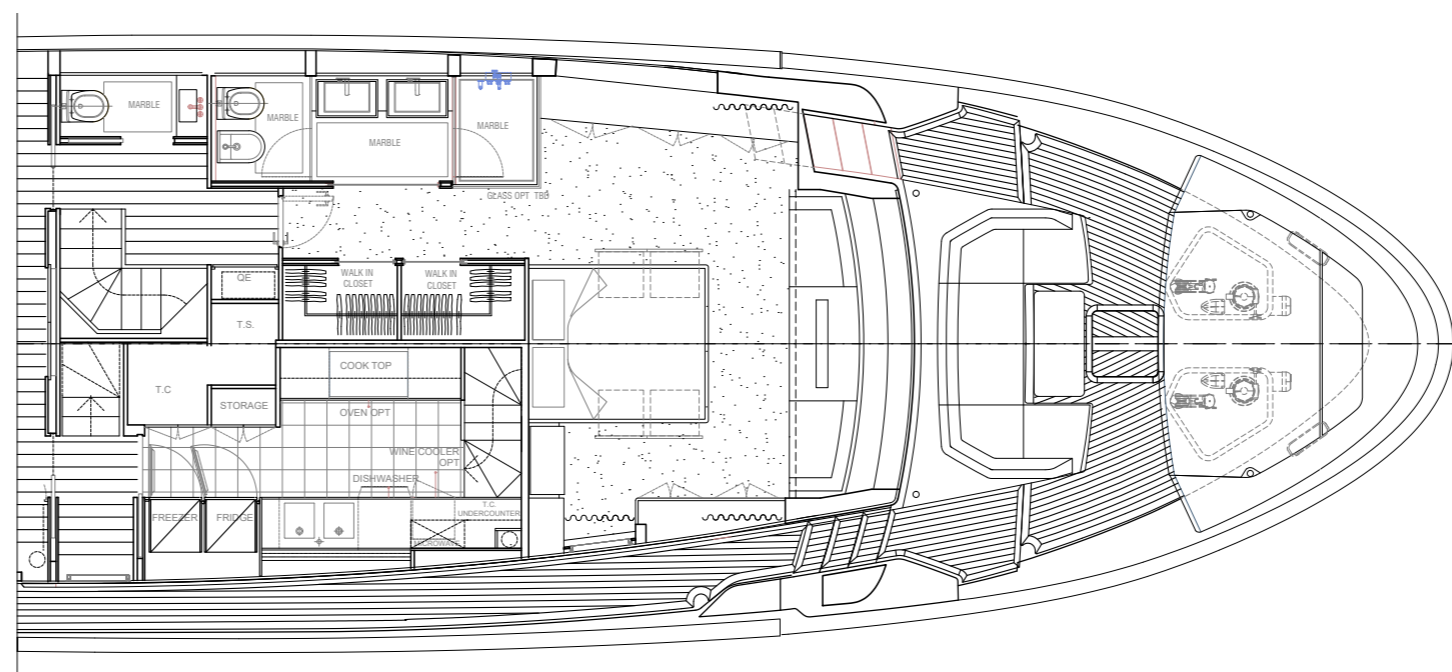
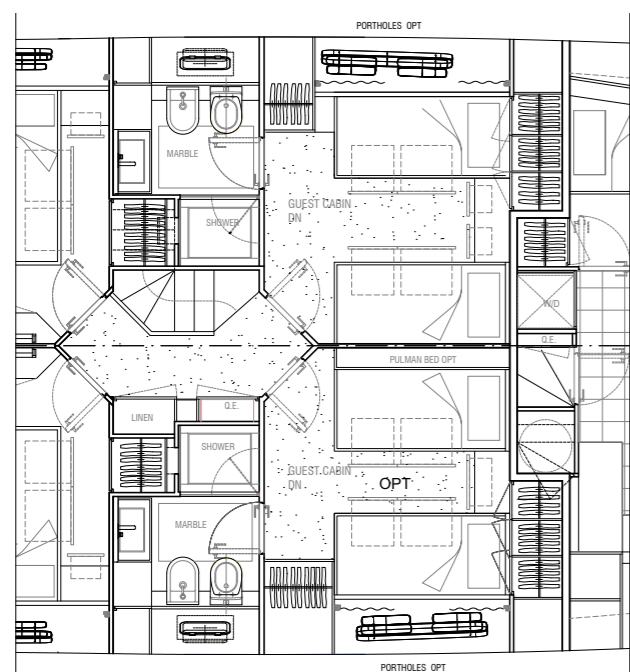
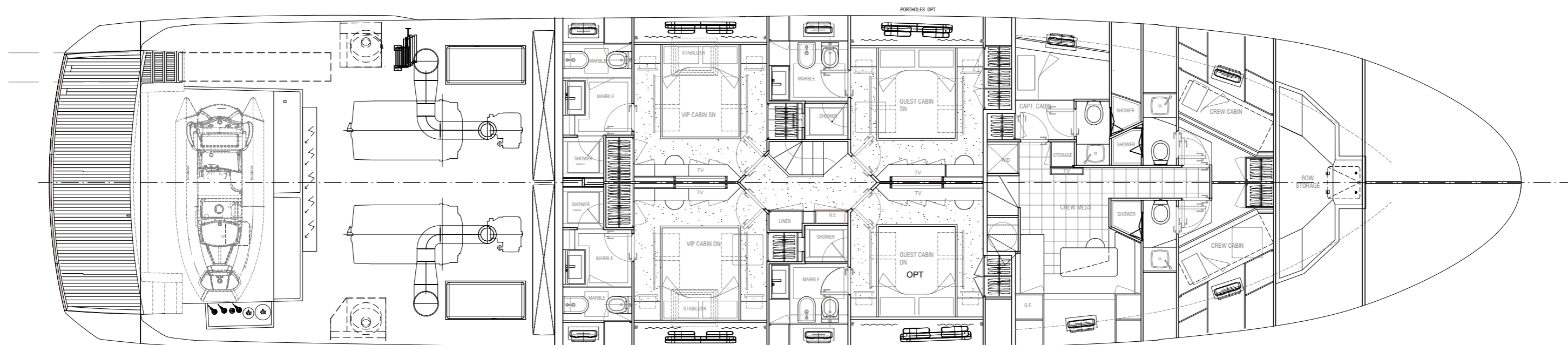

Length overall	31,08 m	
Maximum beam	7,06 m	
Construction height	3,22 m	
Displacement @ half load	110 t	
Displacement @ full load	116 t	
Waterline length @ half load	23,97 m	
Waterline length @ full load	24,1 m	
Draught @ half load	1,82 m	
Draught @ full load	1,9 m	
Guest accommodation	10 people	
Crew accommodation	5 people	
Engine	a) 2 x MTU 16V2000M86 (2216 HP)	b) 2 x MTU 16V2000M96 (2434 HP)
Consumption (approx)	a) 2 x 365 lt/h @2200rpm	b) 2 x 375 lt/h @2200rpm
Power output @ 100% MCR	a) 2 x 1630 kW @2450rpm	b) 2 x 1790 kW @2450rpm
Gearbox	a) 2 x ZF BW 3060V, R=3:1	b) 2 x ZF BW 3060V, R=3:1
Transmission	V-drive	
Propeller	In Nibral in class "S"	
Shafts	In Aquamet 17 or equivalent	
Gensets	2 x 45 kW	
Rudders	AISI316 Stainless Steel	
Maximum speed (approx)	a) 26 kn	b) 28 kn
Cruising speed (approx.)	a) 23 kn	b) 24 kn
Economical speed (approx)	10 kn	
Max range @ economical speed (approx)	1350 nm	
Deadrise	16°	
A/C power	180000 btu/h	
Fuel capacity	12100 l	
Fresh water capacity	1900 l	
Black water capacity	900 l	
Grey water capacity	850 l	
Tender length	max 4,5 m	
Tender weight	max 950 kg	

It's not an investment if it's destroying



INFUSION LAYUP SYSTEM

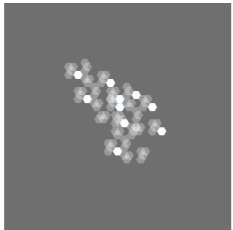

BIO RESIN & CORE



FSC CERTIFIED WOOD SUPPLY



FORMALDEHYDE FREE FURNITURE



LED LIGHTING



BIOCHROME®



SUSTAINABLE LEATHER



CLASS A++

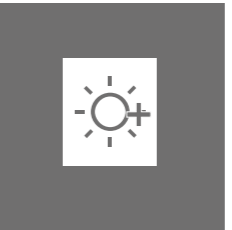

SOLAR PANELS



HULL EFFICIENCY



THERMAL INSULATION